

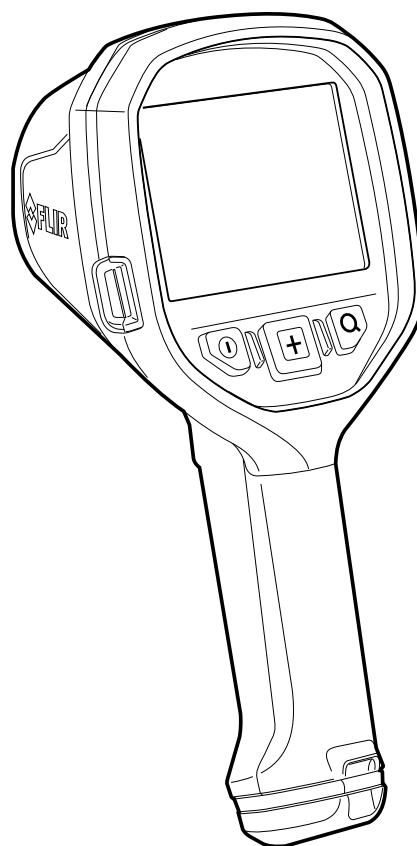

User's manual FLIR Kxx series



Important note

Before operating the device, you must read, understand, and follow all instructions, warnings, cautions, and legal disclaimers.

Důležitá poznámka

Před použitím zařízení si přečtěte veškeré pokyny, upozornění, varování a vyvázání se ze záruky, ujistěte se, že jim rozumíte, a řiďte se jimi.

Viktig meddelelse

Før du betjener enheden, skal du læse, forstå og følge alle anvisninger, advarsler, sikkerhedsforanstaltninger og ansvarsfraskrivelser.

Wichtiger Hinweis

Bevor Sie das Gerät in Betrieb nehmen, lesen, verstehen und befolgen Sie unbedingt alle Anweisungen, Warnungen, Vorsichtshinweise und Haftungsausschlüsse

Σημαντική σημείωση

Πριν από τη λειτουργία της συσκευής, πρέπει να διαβάσετε, να κατανοήσετε και να ακολουθήσετε όλες τις οδηγίες, προειδοποιήσεις, προφυλάξεις και νομικές αποποιήσεις.

Nota importante

Antes de usar el dispositivo, debe leer, comprender y seguir toda la información sobre instrucciones, advertencias, precauciones y renunciaciones de responsabilidad.

Tärkeä huomautus

Ennen laitteen käyttämistä on luettava ja ymmärrettävä kaikki ohjeet, vakavat varoitukset, varoitukset ja lakitiedotteet sekä noudatettava niitä.

Remarque importante

Avant d'utiliser l'appareil, vous devez lire, comprendre et suivre l'ensemble des instructions, avertissements, mises en garde et clauses légales de non-responsabilité.

Fontos megjegyzés

Az eszköz használatá elött figyelmesen olvassa el és tartsa be az összes utasítást, figyelmeztetést, óvintézkedést és jogi nyilatkozatot.

Nota importante

Prima di utilizzare il dispositivo, è importante leggere, capire e seguire tutte le istruzioni, avvertenze, precauzioni ed esclusioni di responsabilità legali.

重要な注意

デバイスをご使用になる前に、あらゆる指示、警告、注意事項、および免責条項をお読み頂き、その内容を理解して従ってください。

중요한 참고 사항

장치를 작동하기 전에 반드시 다음의 사용 설명서와 경고, 주의사항, 법적 책임제한을 읽고 이해하며 따라야 합니다.

Viktig

Før du bruker enheten, må du lese, forstå og følge instruksjoner, advarsler og informasjon om ansvarsfraskrivelse.

Belangrijke opmerking

Zorg ervoor dat u, voordat u het apparaat gaat gebruiken, alle instructies, waarschuwingen en juridische informatie hebt doorgelezen en begrepen, en dat u deze opvolgt en in acht neemt.

Ważna uwaga

Przed rozpoczęciem korzystania z urządzenia należy koniecznie zapoznać się z wszystkimi instrukcjami, ostrzeżeniami, przestrogami i uwagami prawnymi. Należy zawsze postępować zgodnie z zaleceniami tam zawartymi.

Nota importante

Antes de utilizar o dispositivo, deverá proceder à leitura e compreensão de todos os avisos, precauções, instruções e isenções de responsabilidade legal e assegurar-se do seu cumprimento.

Важное примечание

До того, как пользоваться устройством, вам необходимо прочитать и понять все предупреждения, предостережения и юридические ограничения ответственности и следовать им.

Viktig information

Innan du använder enheten måste du läsa, förstå och följa alla anvisningar, varningar, försiktighetsåtgärder och ansvarsfriskrivningar.

Önemli not

Cihazı çalıştırmadan önce tüm talimatları, uyarıları, ikazları ve yasal açıklamaları okumalı, anlamalı ve bunlara uymalısınız.

重要注意事項

在操作设备之前，您必须阅读、理解并遵循所有说明、警告、注意事项和法律免责声明。

重要注意事項

操作裝置之前，您務必閱讀、了解並遵循所有說明、警告、注意事項與法律免責聲明。



User's manual FLIR Kxx series



Table of contents

1	Legal disclaimer	1
1.1	Legal disclaimer	1
1.2	Usage statistics	1
1.3	Changes to registry	1
1.4	U.S. Government Regulations.....	1
1.5	Copyright	1
1.6	Quality assurance	1
1.7	Patents.....	1
1.8	EULA Terms	1
2	Safety information	2
2.1	Label affixed to the camera	5
2.2	Marking recommendations and restrictions.....	5
3	Notice to user	6
3.1	User-to-user forums	6
3.2	Disposal of electronic waste	6
3.3	Training	6
3.4	Documentation updates	6
3.5	Important note about this manual.....	6
3.6	Note about authoritative versions.....	6
4	Customer help	7
4.1	General	7
4.2	Submitting a question	8
4.3	Downloads	8
5	Important information about FLIR Kxx series service	9
6	Introduction	10
6.1	NFPA-approved firefighting cameras (FLIR K65).....	11
6.1.1	What is the NFPA?	11
6.1.2	Current standards for thermal imaging cameras	11
6.1.3	Interoperability/usability	11
6.1.4	Image quality.....	11
6.1.5	Durability	11
6.1.6	FLIR K65: NFPA-approved firefighting camera.....	12
6.1.7	Easy-to-use, even with gloves on	12
6.1.8	Clear and crisp thermal images	12
6.1.9	Rugged and reliable.....	12
7	Quick start guide	13
8	List of accessories and services	14
9	System parts	15
9.1	Camera (FLIR K45, FLIR K55).....	15
9.1.1	Figure.....	15
9.1.2	Explanation.....	15
9.2	Camera (FLIR K65).....	16
9.2.1	Figure.....	16
9.2.2	Explanation.....	16
9.3	Lanyard strap and retractable lanyard.....	17
9.4	Neck strap.....	17
10	Screen elements	18
10.1	FLIR K45, FLIR K55	18
10.1.1	Figure.....	18

Table of contents

10.1.2	Explanation	18
10.2	FLIR K65	19
10.2.1	Figure	19
10.3	Battery condition indicator	21
11	Operation	22
11.1	Removing the battery (FLIR K45, FLIR K55)	22
11.1.1	Procedure	22
11.2	Removing the battery (FLIR K65)	23
11.2.1	Procedure	23
11.3	Charging the battery	23
11.3.1	General	23
11.3.2	Procedure	23
11.4	Turning on and turning off the camera	24
11.5	Selecting camera modes (FLIR K45, FLIR K55)	24
11.5.1	General	24
11.5.2	Explanation of the different camera modes	24
11.6	Selecting camera modes (FLIR K65)	27
11.6.1	General	27
11.6.2	Explanation of the different camera modes	28
11.7	Saving an image	31
11.7.1	General	31
11.7.2	Figure	31
11.7.3	Procedure	31
11.8	Recording a video clip	32
11.8.1	General	32
11.8.2	Figure	32
11.8.3	Procedure	32
11.9	Connecting the camera to a computer	33
11.9.1	General	33
11.9.2	Procedure (FLIR K45, FLIR K55)	33
11.9.3	Procedure (FLIR K65)	34
11.10	Viewing saved images	36
11.10.1	General	36
11.10.2	Procedure	36
11.11	Viewing saved video clips	37
11.11.1	General	37
11.11.2	Procedure	37
11.12	Changing settings (in the camera)	38
11.12.1	General	38
11.12.2	Procedure	38
11.13	Changing settings (in FLIR Tools)	39
11.13.1	The <i>General settings</i> tab	39
11.13.2	The <i>User interface</i> tab	40
12	In-truck charger (optional accessory)	42
12.1	Introduction	42
12.2	Parts and functions	43
12.3	Choosing a suitable position	43
12.4	Recommended cable area and fuse	43
12.5	Mounting instructions	44
12.6	Charging the camera	44

Table of contents

12.7	Charging a battery separately	44
12.8	Cleaning	44
12.9	Customer support	45
13	Technical data	46
13.1	Online field-of-view calculator	46
13.2	Note about technical data	46
13.3	Note about authoritative versions.....	46
13.4	FLIR K45	47
13.5	FLIR K55	52
13.6	FLIR K65	57
13.7	In-truck charger	62
14	Mechanical drawings	64
15	CE Declaration of conformity	68
16	Cleaning, decontamination and disinfection	70
16.1	Cleaning	70
16.1.1	Camera housing, cables, and other items	70
16.1.2	Infrared lens.....	70
16.2	Decontamination and disinfection	71
17	Maintenance, inspection, and service	72
17.1	Maintenance.....	72
17.2	Inspection	72
17.3	Service.....	72
18	Storage conditions	73
19	About FLIR Systems	74
19.1	More than just an infrared camera	75
19.2	Sharing our knowledge	75
19.3	Supporting our customers.....	76
19.4	A few images from our facilities.....	76
20	History of infrared technology.....	77

1.1 Legal disclaimer

All products manufactured by FLIR Systems are warranted against defective materials and workmanship for a period of one (1) year from the delivery date of the original purchase, provided such products have been under normal storage, use and service, and in accordance with FLIR Systems instruction.

Uncooled handheld infrared cameras manufactured by FLIR Systems are warranted against defective materials and workmanship for a period of two (2) years from the delivery date of the original purchase, provided such products have been under normal storage, use and service, and in accordance with FLIR Systems instruction, and provided that the camera has been registered within 60 days of original purchase.

Detectors for uncooled handheld infrared cameras manufactured by FLIR Systems are warranted against defective materials and workmanship for a period of ten (10) years from the delivery date of the original purchase, provided such products have been under normal storage, use and service, and in accordance with FLIR Systems instruction, and provided that the camera has been registered within 60 days of original purchase.

Products which are not manufactured by FLIR Systems but included in systems delivered by FLIR Systems to the original purchaser, carry the warranty, if any, of the particular supplier only. FLIR Systems has no responsibility whatsoever for such products.

The warranty extends only to the original purchaser and is not transferable. It is not applicable to any product which has been subjected to misuse, neglect, accident or abnormal conditions of operation. Expendable parts are excluded from the warranty.

In the case of a defect in a product covered by this warranty the product must not be further used in order to prevent additional damage. The purchaser shall promptly report any defect to FLIR Systems or this warranty will not apply.

FLIR Systems will, at its option, repair or replace any such defective product free of charge if, upon inspection, it proves to be defective in material or workmanship and provided that it is returned to FLIR Systems within the said one-year period.

FLIR Systems has no other obligation or liability for defects than those set forth above.

No other warranty is expressed or implied. FLIR Systems specifically disclaims the implied warranties of merchantability and fitness for a particular purpose.

FLIR Systems shall not be liable for any direct, indirect, special, incidental or consequential loss or damage, whether based on contract, tort or any other legal theory.

This warranty shall be governed by Swedish law.

Any dispute, controversy or claim arising out of or in connection with this warranty, shall be finally settled by arbitration in accordance with the Rules of the Arbitration Institute of the Stockholm Chamber of Commerce. The place of arbitration shall be Stockholm. The language to be used in the arbitral proceedings shall be English.

1.2 Usage statistics

FLIR Systems reserves the right to gather anonymous usage statistics to help maintain and improve the quality of our software and services.

1.3 Changes to registry

The registry entry HKEY_LOCAL_MACHINE\SYSTEM\CurrentControlSet\Control\Lsa\LmCompatibilityLevel will be automatically changed to level 2 if the FLIR Camera Monitor service detects a FLIR camera connected to the computer with a USB cable. The modification will only be executed if the camera device implements a remote network service that supports network logons.

1.4 U.S. Government Regulations

This product may be subject to U.S. Export Regulations. Please send any inquiries to exportquestions@flir.com.

1.5 Copyright

© 2015, FLIR Systems, Inc. All rights reserved worldwide. No parts of the software including source code may be reproduced, transmitted, transcribed or translated into any language or computer language in any form or by any means, electronic, magnetic, optical, manual or otherwise, without the prior written permission of FLIR Systems.

The documentation must not, in whole or part, be copied, photocopied, reproduced, translated or transmitted to any electronic medium or machine readable form without prior consent, in writing, from FLIR Systems.

Names and marks appearing on the products herein are either registered trademarks or trademarks of FLIR Systems and/or its subsidiaries. All other trademarks, trade names or company names referenced herein are used for identification only and are the property of their respective owners.

1.6 Quality assurance

The Quality Management System under which these products are developed and manufactured has been certified in accordance with the ISO 9001 standard.

FLIR Systems is committed to a policy of continuous development; therefore we reserve the right to make changes and improvements on any of the products without prior notice.

1.7 Patents

One or several of the following patents and/or design patents may apply to the products and/or features. Additional pending patents and/or pending design patents may also apply.

000279476-0001; 000439161; 000499579-0001; 000653423; 000726344; 000859020; 001106306-0001; 001707738; 001707746; 001707787; 001776519; 001954074; 002021543; 002058180; 002249953; 002531178; 0600574-8; 1144833; 1182246; 1182620; 1285345; 1299699; 1325808; 1336775; 1391114; 1402918; 1404291; 1411581; 1415075; 1421497; 1458284; 1678485; 1732314; 2106017; 2107799; 2381417; 3006596; 3006597; 466540; 483782; 484155; 4889913; 5177595; 60122153.2; 602004011681.5-08; 6707044; 68657; 7034300; 7110035; 7154093; 7157705; 7237946; 7312822; 7332716; 7336823; 7544944; 7667198; 7809258 B2; 7826736; 8,153,971; 8,823,803; 8,853,631; 8018649 B2; 8212210 B2; 8289372; 8354639 B2; 8384783; 8520970; 8565547; 8595689; 8599262; 8654239; 8680468; 8803093; D540838; D549758; D579475; D584755; D599,392; D615,113; D664,580; D664,581; D665,004; D665,440; D677298; D710,424 S; D718801; DI6702302-9; DI6903617-9; DI7002221-6; DI7002891-5; DI7002892-3; DI7005799-0; DM/057692; DM/061609; EP 2115696 B1; EP2315433; SE 0700240-5; US 8340414 B2; ZL 20130267619.5; ZL01823221.3; ZL01823226.4; ZL02331553.9; ZL02331554.7; ZL200480034894.0; ZL200530120994.2; ZL200610088759.5; ZL200630130114.4; ZL200730151141.4; ZL200730339504.7; ZL200820105768.8; ZL200830128581.2; ZL200880105236.4; ZL200880105769.2; ZL200930190061.9; ZL201030176127.1; ZL201030176130.3; ZL201030176157.2; ZL201030595931.3; ZL201130442354.9; ZL201230471744.3; ZL201230620731.8.

1.8 EULA Terms

- You have acquired a device ("INFRARED CAMERA") that includes software licensed by FLIR Systems AB from Microsoft Licensing, GP or its affiliates ("MS"). Those installed software products of MS origin, as well as associated media, printed materials, and "online" or electronic documentation ("SOFTWARE") are protected by international intellectual property laws and treaties. The SOFTWARE is licensed, not sold. All rights reserved.
- IF YOU DO NOT AGREE TO THIS END USER LICENSE AGREEMENT ("EULA"), DO NOT USE THE DEVICE OR COPY THE SOFTWARE. INSTEAD, PROMPTLY CONTACT FLIR Systems AB FOR INSTRUCTIONS ON RETURN OF THE UNUSED DEVICE(S) FOR A REFUND. **ANY USE OF THE SOFTWARE, INCLUDING BUT NOT LIMITED TO USE ON THE DEVICE, WILL CONSTITUTE YOUR AGREEMENT TO THIS EULA (OR RATIFICATION OF ANY PREVIOUS CONSENT).**
- GRANT OF SOFTWARE LICENSE.** This EULA grants you the following license:
 - You may use the SOFTWARE only on the DEVICE.
 - NOT FAULT TOLERANT.** THE SOFTWARE IS NOT FAULT TOLERANT. FLIR Systems AB HAS INDEPENDENTLY DETERMINED HOW TO USE THE SOFTWARE IN THE DEVICE, AND MS HAS RELIED UPON FLIR Systems AB TO CONDUCT SUFFICIENT TESTING TO DETERMINE THAT THE SOFTWARE IS SUITABLE FOR SUCH USE.
 - NO WARRANTIES FOR THE SOFTWARE.** THE SOFTWARE IS PROVIDED "AS IS" and with all faults. THE ENTIRE RISK AS TO SATISFACTORY QUALITY, PERFORMANCE, ACCURACY, AND EFFORT (INCLUDING LACK OF NEGLIGENCE) IS WITH YOU. ALSO, THERE IS NO WARRANTY AGAINST INTERFERENCE WITH YOUR ENJOYMENT OF THE SOFTWARE OR AGAINST INFRINGEMENT. **IF YOU HAVE RECEIVED ANY WARRANTIES REGARDING THE DEVICE OR THE SOFTWARE, THOSE WARRANTIES DO NOT ORIGINATE FROM, AND ARE NOT BINDING ON, MS.**
 - No Liability for Certain Damages. **EXCEPT AS PROHIBITED BY LAW, MS SHALL HAVE NO LIABILITY FOR ANY INDIRECT, SPECIAL, CONSEQUENTIAL OR INCIDENTAL DAMAGES ARISING FROM OR IN CONNECTION WITH THE USE OR PERFORMANCE OF THE SOFTWARE. THIS LIMITATION SHALL APPLY EVEN IF ANY REMEDY FAILS OF ITS ESSENTIAL PURPOSE. IN NO EVENT SHALL MS BE LIABLE FOR ANY AMOUNT IN EXCESS OF U.S. TWO HUNDRED FIFTY DOLLARS (U.S.\$250.00).**
 - Limitations on Reverse Engineering, Decompilation, and Disassembly.** You may not reverse engineer, decompile, or disassemble the SOFTWARE, except and only to the extent that such activity is expressly permitted by applicable law notwithstanding this limitation.
 - SOFTWARE TRANSFER ALLOWED BUT WITH RESTRICTIONS.** You may permanently transfer rights under this EULA only as part of a permanent sale or transfer of the Device, and only if the recipient agrees to this EULA. If the SOFTWARE is an upgrade, any transfer must also include all prior versions of the SOFTWARE.
 - EXPORT RESTRICTIONS.** You acknowledge that SOFTWARE is subject to U.S. export jurisdiction. You agree to comply with all applicable international and national laws that apply to the SOFTWARE, including the U.S. Export Administration Regulations, as well as end-user, end-use and destination restrictions issued by U.S. and other governments. For additional information see <http://www.micro-soft.com/exporting/>.

Safety information



WARNING

Applicability: Cameras with one or more batteries.

Do not disassemble or do a modification to the battery. The battery contains safety and protection devices which, if damage occurs, can cause the battery to become hot, or cause an explosion or an ignition.



WARNING

Applicability: Cameras with one or more batteries.

If there is a leak from the battery and you get the fluid in your eyes, do not rub your eyes. Flush well with water and immediately get medical care. The battery fluid can cause injury to your eyes if you do not do this.



WARNING

Applicability: Cameras with one or more batteries.

Do not continue to charge the battery if it does not become charged in the specified charging time. If you continue to charge the battery, it can become hot and cause an explosion or ignition. Injury to persons can occur.



WARNING

Applicability: Cameras with one or more batteries.

Only use the correct equipment to remove the electrical power from the battery. If you do not use the correct equipment, you can decrease the performance or the life cycle of the battery. If you do not use the correct equipment, an incorrect flow of current to the battery can occur. This can cause the battery to become hot, or cause an explosion. Injury to persons can occur.



WARNING

Make sure that you read all applicable MSDS (Material Safety Data Sheets) and warning labels on containers before you use a liquid. The liquids can be dangerous. Injury to persons can occur.



CAUTION

Do not point the infrared camera (with or without the lens cover) at strong energy sources, for example, devices that cause laser radiation, or the sun. This can have an unwanted effect on the accuracy of the camera. It can also cause damage to the detector in the camera.



CAUTION

Applicability: Cameras with one or more batteries.

Do not attach the batteries directly to a car's cigarette lighter socket, unless FLIR Systems supplies a specific adapter to connect the batteries to a cigarette lighter socket. Damage to the batteries can occur.



CAUTION

Applicability: Cameras with one or more batteries.

Do not connect the positive terminal and the negative terminal of the battery to each other with a metal object (such as wire). Damage to the batteries can occur.



CAUTION

Applicability: Cameras with one or more batteries.

Do not get water or salt water on the battery, or permit the battery to become wet. Damage to the batteries can occur.

 **CAUTION**

Applicability: Cameras with one or more batteries.

Do not make holes in the battery with objects. Damage to the battery can occur.

 **CAUTION**

Applicability: Cameras with one or more batteries.

Do not hit the battery with a hammer. Damage to the battery can occur.

 **CAUTION**

Applicability: Cameras with one or more batteries.

Do not put your foot on the battery, hit it or cause shocks to it. Damage to the battery can occur.

 **CAUTION**

Applicability: Cameras with one or more batteries.

Do not put the batteries in or near a fire, or into direct sunlight. When the battery becomes hot, the built-in safety equipment becomes energized and can stop the battery charging procedure. If the battery becomes hot, damage can occur to the safety equipment and this can cause more heat, damage or ignition of the battery.

 **CAUTION**

Applicability: Cameras with one or more batteries.

Do not put the battery on a fire or increase the temperature of the battery with heat. Damage to the battery and injury to persons can occur.

 **CAUTION**

Applicability: Cameras with one or more batteries.

Do not put the battery on or near fires, stoves, or other high-temperature locations. Damage to the battery and injury to persons can occur.

 **CAUTION**

Applicability: Cameras with one or more batteries.

Do not solder directly onto the battery. Damage to the battery can occur.

 **CAUTION**

Applicability: Cameras with one or more batteries.

Do not use the battery if, when you use, charge, or put the battery in storage, there is an unusual smell from the battery, the battery feels hot, changes color, changes shape, or is in an unusual condition. Speak with your sales office if one or more of these problems occurs. Damage to the battery and injury to persons can occur.

 **CAUTION**

Applicability: Cameras with one or more batteries.

Only use a specified battery charger when you charge the battery. Damage to the battery can occur if you do not do this.

 **CAUTION**

Applicability: Cameras with one or more batteries.

Only use a specified battery for the camera. Damage to the camera and the battery can occur if you do not do this.

 **CAUTION**

Applicability: Cameras with one or more batteries.

The temperature range through which you can charge the battery is $\pm 0^{\circ}\text{C}$ to $+45^{\circ}\text{C}$ ($+32^{\circ}\text{F}$ to $+113^{\circ}\text{F}$), unless other information is specified in the user documentation or technical data. If you charge the battery at temperatures out of this range, it can cause the battery to become hot or to break. It can also decrease the performance or the life cycle of the battery.

 **CAUTION**

Applicability: Cameras with one or more batteries.

The temperature range through which you can remove the electrical power from the battery is -15°C to $+50^{\circ}\text{C}$ ($+5^{\circ}\text{F}$ to $+122^{\circ}\text{F}$), unless other information is specified in the user documentation or technical data. If you operate the battery out of this temperature range, it can decrease the performance or the life cycle of the battery.

 **CAUTION**

Applicability: Cameras with one or more batteries.

When the battery is worn, apply insulation to the terminals with adhesive tape or equivalent materials before you discard it. Damage to the battery and injury to persons can occur if you do not do this.

 **CAUTION**

Applicability: Cameras with one or more batteries.

Remove any water or moisture on the battery before you install it. Damage to the battery can occur if you do not do this.

 **CAUTION**

Do not apply solvents or equivalent liquids to the camera, the cables, or other items. Damage to the battery and injury to persons can occur.

 **CAUTION**

Be careful when you clean the infrared lens. The lens has an anti-reflective coating which is easily damaged. Damage to the infrared lens can occur.

 **CAUTION**







Do not use too much force to clean the infrared lens. This can cause damage to the anti-reflective coating.

 **NOTE**

The encapsulation rating is only applicable when all the openings on the camera are sealed with their correct covers, hatches, or caps. This includes the compartments for data storage, batteries, and connectors.



 **CAUTION**

Do not change the standard fire-fighting procedures when you use a FLIR K series camera. The FLIR K series camera is not a replacement technology.

	CAUTION
Do not use the FLIR K series camera without the correct training. If the persons that operate the camera do not have the correct training, an incorrect analysis of the infrared images can occur. Thus, incorrect decisions during the firefighting can be made.	
The training must include:	
<ul style="list-style-type: none"> • How a thermal camera operates and its limits • How to interpret an image • How to work safely with the camera. 	
	CAUTION
Make sure that you do not use a torque value that is more than 80 Ncm on the Torx T20 screw. Damage to the camera can occur if you do not obey this.	
	CAUTION
Only use the equipment as given in the applicable manufacturer's instructions. If you do not obey this, the protection that the equipment gives can become unsatisfactory. Damage to the equipment can occur.	
	CAUTION
Only use with batteries that have the part number T198310 on them (that FLIR Systems AB supplies). Damage to the equipment can occur if you do not obey this.	
	WARNING
Make sure that you only change the batteries in a known safe area. If you do not obey this, an explosion can occur. An explosion can cause death or injury to persons and damage to the equipment.	
	CAUTION
DO NOT OPEN UNLESS AREA IS KNOWN TO BE FREE OF IGNITIBLE CONCENTRATIONS OF FLAMMABLE SUBSTANCE	
	CAUTION
DO NOT USE CONNECTION PORT WHILE SITUATED IN CLASSIFIED (HAZARDOUS) AREA	

2.1 Label affixed to the camera

Applicability: FLIR K65

<p>FLIR K-SERIES DO NOT REMOVE THIS LABEL! READ MANUAL BEFORE USE! WARNING – EXPLOSION HAZARD – DO NOT CHANGE BATTERIES IN HAZARDOUS LOCATIONS! E114032</p>	  	<p>CAUTION – ONLY TO BE USED WITH BATTERIES MARKED WITH PN T198310 PROVIDED BY FLIR SYSTEMS AB, COMPLIES WITH ANSI/ISA 12.12.01-2013, UL 61010-1, UL50, NEMA3, CLASS 1, DIV 2, GROUPS C AND D, TEMPERATURE CODE T4. THIS THERMAL IMAGER MEETS THE REQUIREMENTS OF NFPA 1801 STANDARD ON THERMAL IMAGERS FOR THE FIRE SERVICE, 2013 EDITION. T amb: -20°C to +85°C (-4°F to +185°F)</p>
---	---	--

2.2 Marking recommendations and restrictions

Applicability: FLIR K65

The camera body may not be physically marked. Such markings include labels, engravings, printing, melting, etc. If the camera needs to be identified or tracked, such identification shall be carried out by adding a custom boot image in the camera firmware, using FLIR Tools.

See section 11.13.2 *The User interface tab*, page 40 for more information.

3.1 User-to-user forums

Exchange ideas, problems, and infrared solutions with fellow thermographers around the world in our user-to-user forums. To go to the forums, visit:

<http://www.infraredtraining.com/community/boards/>

3.2 Disposal of electronic waste



As with most electronic products, this equipment must be disposed of in an environmentally friendly way, and in accordance with existing regulations for electronic waste.

Please contact your FLIR Systems representative for more details.

3.3 Training

To read about infrared training, visit:

- <http://www.infraredtraining.com>
- <http://www.irtraining.com>
- <http://www.irtraining.eu>

3.4 Documentation updates

Our manuals are updated several times per year, and we also issue product-critical notifications of changes on a regular basis.

To access the latest manuals and notifications, go to the Download tab at:

<http://support.flir.com>

It only takes a few minutes to register online. In the download area you will also find the latest releases of manuals for our other products, as well as manuals for our historical and obsolete products.

3.5 Important note about this manual

FLIR Systems issues generic manuals that cover several cameras within a model line.

This means that this manual may contain descriptions and explanations that do not apply to your particular camera model.

3.6 Note about authoritative versions

The authoritative version of this publication is English. In the event of divergences due to translation errors, the English text has precedence.

Any late changes are first implemented in English.

FLIR Customer Support Center

Home [Answers](#) [Ask a Question](#) [Product Registration](#) [Downloads](#) [My Stuff](#) [Service](#)

FLIR Customer support

Get the most out of your FLIR products

Get Support for Your FLIR Products

Welcome to the FLIR Customer Support Center. This portal will help you as a FLIR customer to get the most out of your FLIR products. The portal gives you access to:

- The FLIR Knowledgebase
- Ask our support team (requires registration)
- Software and documentation (requires registration)
- FLIR service contacts

Find Answers











We store all resolved problems in our solution database. Search by product, category, keywords, or phrases.

Search by Keyword



[Search All Answers](#)

[See All Popular Answers](#)

To find a datasheet for a current product, click on a picture.
To find a datasheet for a legacy product, click here.

 FLIR Ex	 FLIR Exx	 FLIR Kxx	 FLIR T4xx	 FLIR T6xx	 FLIR G3xx
 ThermaCAM™ GasFindIR	 FLIR GF3xx	 FLIR AX	 FLIR Ax5	 FLIR A3xx	More...

Product catalog
Please right-click the links below and select [Save Target As...](#) to save the file.

	US Letter (26 MB) A4 (27.4 MB)	
---	-----------------------------------	---

[Important legal disclaimer, dangers, warnings, and cautions](#)

4.1 General

For customer help, visit:

<http://support.flir.com>

4.2 Submitting a question

To submit a question to the customer help team, you must be a registered user. It only takes a few minutes to register online. If you only want to search the knowledgebase for existing questions and answers, you do not need to be a registered user.

When you want to submit a question, make sure that you have the following information to hand:

- The camera model
- The camera serial number
- The communication protocol, or method, between the camera and your device (for example, HDMI, Ethernet, USB, or FireWire)
- Device type (PC/Mac/iPhone/iPad/Android device, etc.)
- Version of any programs from FLIR Systems
- Full name, publication number, and revision number of the manual

4.3 Downloads

On the customer help site you can also download the following:

- Firmware updates for your infrared camera.
- Program updates for your PC/Mac software.
- Freeware and evaluation versions of PC/Mac software.
- User documentation for current, obsolete, and historical products.
- Mechanical drawings (in *.dxf and *.pdf format).
- Cad data models (in *.stp format).
- Application stories.
- Technical datasheets.
- Product catalogs.

Important information about FLIR Kxx series service

- Contact the service department before shipping the camera. Many problems can be resolved on the phone—if so, the camera does not need to be shipped.
- The camera must be thoroughly cleaned, decontaminated and disinfected before shipping to our service department. No hazardous residues are allowed on cameras. Such residues include—but are not limited to—chemical fire-extinguishing compounds, radioactivity, biohazardous materials, and residues from chemical fires.
- FLIR Systems reserves the right to charge the full cost for the decontamination and disinfection of contaminated cameras that are shipped to our service department.



Thank you for choosing a FLIR Kxx series camera from FLIR Systems.

The FLIR Kxx series is a robust and reliable infrared camera series designed to perform under extremely severe conditions. It has an intuitive interface with a design that makes it easy to control even with a gloved hand. The crisp and clear image helps you to navigate through smoke and to make quick and accurate decisions.

Main features:

- **Extremely affordable: a thermal imaging camera in every firefighting truck.** FLIR Systems markets more thermal imaging cameras than any other manufacturer. Thanks to economies of scale, FLIR Systems can market the FLIR Kxx series at an extremely affordable price.
- **Robust and reliable.** The FLIR Kxx series is designed to meet tough operating conditions. It can withstand a drop from 2 m (6.5') onto a concrete floor, is water resistant to IP67, and is fully operating up to +85°C (+185°F), and up to +260°C (+500°F) for 5 min.
- **Clear and crisp thermal images.** The maintenance-free uncooled microbolometer sensor produces clear and detail-rich images. Thermal images are presented on a large, bright 4" display, helping you to navigate and to make quick and accurate decisions.
- **Easy-to-use, and in a gloved firefighter's hand.** An intuitive and simple user interface allows you to focus on the job. The FLIR Kxx series can be controlled by just three large buttons on top of the unit and one trigger. Ideal for a gloved firefighter's hand.
- **Produce simple reports in FLIR Tools.** Thermal images can be stored in the FLIR Kxx series and later used to produce simple reports of what happened at the scene.

6.1 NFPA-approved firefighting cameras (FLIR K65)

Thermal imaging cameras (TICs) have found their way into the toolkits and trucks of fire-fighting teams around the world. But with several different types and brands of TICs on the market, it can be hard to decide which camera to purchase. To simplify that choice and to guarantee that TICs have minimum quality standards that allow firefighters to do their job, the National Fire Protection Association (NFPA) has defined specific criteria for the design, performance, and production of thermal imaging cameras. With the FLIR K65, FLIR Systems offers firefighters a dedicated TIC that has been designed, developed, and tested according to the NFPA 1801-2013 standard.

6.1.1 What is the NFPA?

The international nonprofit organization NFPA has imposed on itself the mission of reducing the worldwide burden of fire and other hazards on the quality of life by providing and advocating consensus codes and standards, research, training, and education. The NFPA is the world's leading advocate of fire prevention and an authoritative source on public safety. It develops, publishes, and disseminates more than 300 consensus codes and standards intended to minimize the possibility and effects of fire and other risks.

With the NFPA 1801-2013 standard, the organization has outlined requirements for new thermal imagers used by fire service personnel during emergency incident operations. NFPA 1801-2013 was established to provide minimum design, manufacturing, testing, performance, and certification requirements for fire service thermal imaging cameras.

6.1.2 Current standards for thermal imaging cameras

The NFPA 1801-2103 standard focuses on three main areas: interoperability/usability, image quality, and durability.

6.1.3 Interoperability/usability

TICs of different types or brands should have similar functionality, so that firefighters can use them with a minimum of training: uniformity of the user interface and ease of camera operation should facilitate training and, ultimately, acceptance of thermal imagers by end users. Among other things, this means that TICs should have a green power button and a basic image mode that displays only a grayscale image with a temperature bar, digital temperature readout, and heat-indicating color with a color reference scale. Another requirement is that a TIC should be easy to operate with a gloved hand.

6.1.4 Image quality

For firefighters, it is critical that a thermal imager provides a quality image. Image quality is vital to quickly visualize a plan of attack, locate hot spots, or even to save lives. NFPA 1801-2013 imaging performance tests pay attention to the field of view, contrast, spatial resolution, and sensitivity. Another important criterion is image recognition: firefighters should be able to easily recognize objects in the thermal image, and the quality of the image should be high enough for use on the fire ground.

6.1.5 Durability

Needless to say, firefighters operate in difficult environments. That is why the NFPA 1801-2013 has durability requirements to help ensure that TICs are fit for fire ground duty. TIC durability tests include ingress protection, heat/flame resistance, impact acceleration and vibration resistance, and corrosion.

Firefighters might also operate in potentially explosive environments. That is why NFPA-compliant TICs must meet ANSI/ISA 12.12.01 Class 1 Division 2 requirements, meaning that TICs are suitable for use in conditions where potentially explosive quantities of dust or vapor may be present.

6.1.6 FLIR K65: NFPA-approved firefighting camera

The FLIR K65 is FLIR's new NFPA-approved TIC that allows firefighters to see more clearly in the darkest, smokiest environments, maneuver more strategically, stay better oriented, and find victims faster.

6.1.7 Easy-to-use, even with gloves on

The FLIR K65 has an intuitive and simple user interface, allowing firefighters to focus on the job at hand. All FLIR K series cameras can be controlled by three large buttons on top of the unit—ideal for a gloved firefighter's hand.

6.1.8 Clear and crisp thermal images

The camera's maintenance-free uncooled microbolometer sensor produces detail-rich images at 320 × 240 pixels. Thermal images are displayed on a large, bright 4" LCD, which makes navigation easier and decisions more efficient and accurate.

The FLIR K65 also has FLIR's proprietary FSX Flexible Scene Enhancement technology, which enhances thermal images through real-time digital processing inside the camera. The result is an ultra-sharp image that shows extraordinary structural, edge, and other instantly recognizable detail. This helps make it much easier for firefighters and rescue teams to find their way through the smokiest, darkest environments, and to instantly identify targets in scenes with extreme temperature dynamics.

6.1.9 Rugged and reliable

The FLIR K65 is designed to meet tough operating conditions. It can withstand a drop from 2 m onto a concrete floor, is water resistant (IP67), and fully operating up to +260°C/+500° F for 5 minutes.

Firefighters sometimes operate in potentially explosive environments, such as on oil platforms or in the petro-chemical or power generation industries. That is why the NFPA-compliant FLIR K65 also meets the HazLoc standard, meaning that it is suitable for use in hazardous, potentially explosive conditions. As possible ignition sources, the camera's USB port and battery compartment are well protected and cannot be opened during normal operational conditions or operational maintenance. They are also sealed to restrict entry of the external atmosphere.

Follow this procedure to get started right away:

1. Charge the battery for 4 hours before starting the camera for the first time, or until the blue battery condition LED glows continuously.
2. Push the on/off button to turn on the camera.
3. Aim the camera toward the object of interest.
4. Select a suitable camera mode by pushing the Mode button.
5. Pull the Save trigger to save an image.
6. Connect the camera to a computer, using the USB cable.
7. Do one of the following:
 - Move the image to the computer using a drag-and-drop operation in Microsoft Windows Explorer.

**NOTE**

Moving an image using a drag-and-drop operation does not delete the image in the camera.

- Move the image to the computer using FLIR Tools. A download card for FLIR Tools is included in the transport case. In FLIR Tools you can analyze the images and create PDF reports.

List of accessories and services

Product name	Part number
Battery charger, incl. power supply with multi plugs (Exx, Kxx)	T198125
Cigarette lighter adapter kit, 12 VDC, 1.2 m/3.9 ft.	T198509
In-truck charger	T198322
Li-Ion Battery pack 3.6 V 16 Wh	T198310ACC
Neck strap	T127724ACC
One year Extended warranty for Kxx series	T199844
Retractable lanyard	T127722ACC
Strap lanyard	T198416ACC
Transport case Kxx	T198441ACC
Tripod Adapter, Kxx	T198457ACC
USB cable Std A <-> Mini-B	1910423



NOTE

FLIR Systems reserves the right to discontinue models, parts or accessories, and other items, or to change specifications at any time without prior notice.

9.1 Camera (FLIR K45, FLIR K55)

9.1.1 Figure

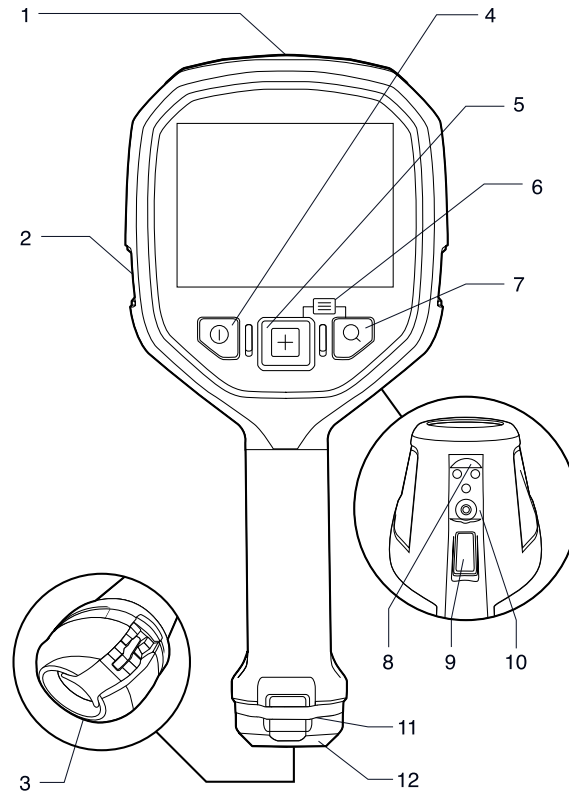

9.1.2 Explanation

1. USB Mini-B connector: Connect to a computer to download images using FLIR Tools.
2. Attachment point for the lanyard strap/neck strap (left and right side).
3. Eccentric latch to secure the battery.
4. On/off button. This button has three functions:
 - Push the on/off button to turn on the camera.
 - Push and hold the on/off button for more than 3 seconds but less than 10 seconds to put the camera into the standby mode. The camera then automatically turns off after 6 hours.
 - Push and hold the on/off button for more than 10 seconds to turn off the camera.
5. Mode button: Push repeatedly to select camera modes.
6. Access to setup menus and stored images: Push Mode + Zoom button.
7. Zoom button (zoom factor 2×).
8. Connectors for in-truck charger.
9. Save trigger.
10. Mount for tripod adapter.
11. Attachment point for the retractable lanyard.
12. Battery.

9.2 Camera (FLIR K65)

9.2.1 Figure

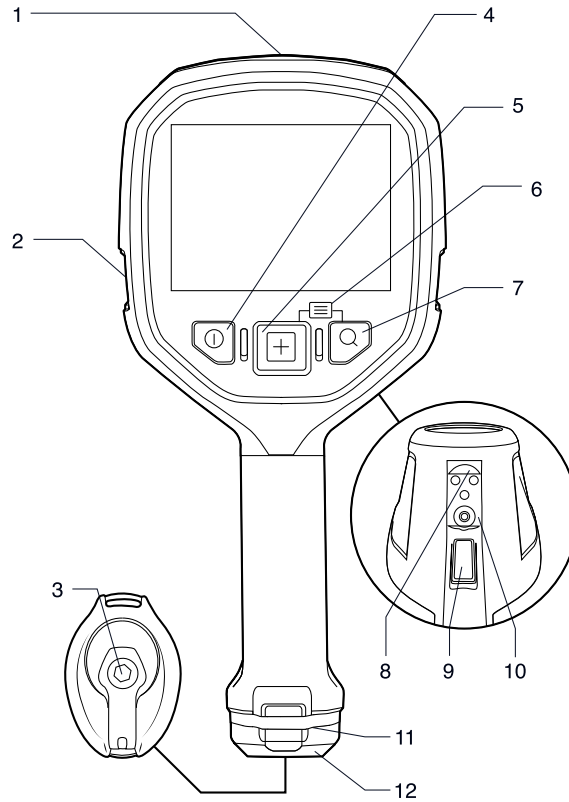

9.2.2 Explanation

1. USB Mini-B connector: Connect to a computer to download images using FLIR Tools. The USB Mini-B connector is protected by plastic cover that is fastened with a Torx screw (T20).



CAUTION

Make sure that you do not use a torque value that is more than 80 Ncm on the Torx T20 screw. Damage to the camera can occur if you do not obey this.

2. Attachment point for lanyard strap/neck strap (left and right side).
3. Latch to secure the battery. The latch is fastened with a Torx screw (T20).



CAUTION

Make sure that you do not use a torque value that is more than 80 Ncm on the Torx T20 screw. Damage to the camera can occur if you do not obey this.

-
4. On/off button. This button has three functions:
 - Push the on/off button to turn on the camera.
 - Push and hold the on/off button for more than 3 seconds but less than 10 seconds to put the camera into the standby mode. The camera then automatically turns off after 6 hours.
 - Push and hold the on/off button for more than 10 seconds to turn off the camera.
 5. Mode button: Push repeatedly to select camera modes.
 6. Access to the setup menus and stored images: Push the Mode + Zoom buttons.
 7. Zoom button (zoom factor $\times 2$).
 8. Connectors for the in-truck charger.
 9. Save trigger.
 10. Mount for the tripod adapter.
 11. Attachment point for the retractable lanyard.
 12. Battery.

9.3 Lanyard strap and retractable lanyard

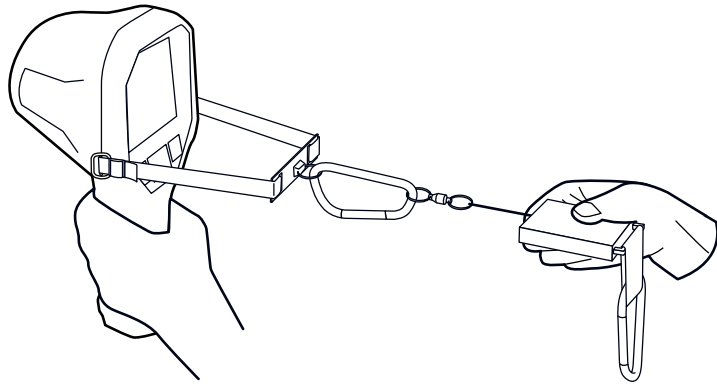

9.4 Neck strap

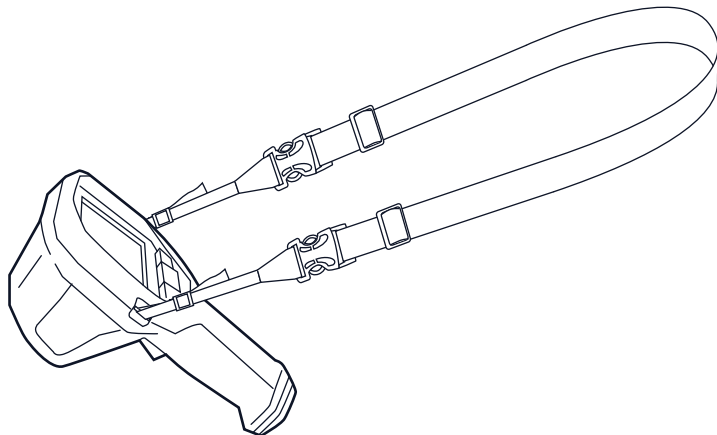

10.1 FLIR K45, FLIR K55

10.1.1 Figure



10.1.2 Explanation

1. Heat detection mode. Optimized for searching hotspots during overhaul after the fire is out.
2. Search and rescue mode. Optimized for maintaining high contrast in the infrared image while searching for people.
3. Fire mode. Similar to the Basic mode, but with a higher-temperature starting point for the heat colorization.
4. Black and white firefighting mode. Multipurpose mode for the initial fire attack with life rescuing operation and control of the fire.
5. Basic mode. Multipurpose mode for the initial fire attack with life rescuing operation and control of the fire.
6. Overheating indicator. The indicator provides a visual warning to the user that the thermal imager is about to shut down due to internal overheating.
7. Temperature scale.
8. Spotmeter.
9. Battery condition indicator.
10. Spotmeter temperature.



NOTE

- The green icon color indicates that the camera automatically switches between the high-sensitivity range and the low-sensitivity range, depending on the object.
- The blue icon color indicates that the temperature range is locked.

10.2 FLIR K65

10.2.1 Figure











1. NFFPA Basic Plus heat detection mode. Optimized for searching hotspots during overhaul after the fire is out.
2. NFFPA Basic Plus search and rescue mode. Optimized for maintaining high contrast in the infrared image while searching for people.
3. NFFPA Basic Plus fire mode. Similar to the Basic mode, but with a higher-temperature starting point for the heat colorization.
4. NFFPA Basic Plus black and white firefighting mode. Multipurpose mode for the initial fire attack with life rescuing operation and control of the fire.
5. NFFPA Basic Plus mode. Multipurpose mode for the initial fire attack with life rescuing operation and control of the fire.
6. Low-sensitivity mode indicator. The indicator is displayed when the camera identifies a hot area and automatically switches to the low-sensitivity mode in the NFFPA Basic mode, NFFPA Basic Plus black and white firefighting mode, or NFFPA Basic Plus fire mode.
7. Overheating indicator. The indicator provides a visual warning to the user that the thermal imager is about to shut down due to internal overheating.

-
8. Change in the color reference indicator symbol. When a new mode is selected, a change in the color temperature reference triangle appears above the scale. The triangle remains visible for 1 second.
 9. Temperature scale.
 10. Spotmeter.
 11. Battery condition indicator.
 12. Spotmeter temperature.
 13. Plus sign, indicating that the camera is in one of the four NFPA Basic Plus modes (i.e., NFPA Basic Plus black and white firefighting mode, NFPA Basic Plus fire mode, NFPA Basic Plus search and rescue mode, or NFPA Basic Plus heat detection mode).

**NOTE**

- Working in an NFPA Basic Plus mode may require additional training.
- The green icon color indicates that the camera automatically switches between the high-sensitivity range and the low-sensitivity range, depending on the object.
- The blue icon color indicates that the temperature range is locked.

10.3 Battery condition indicator

Auto range	High sensitivity range	Explanation
		75% power
		50% power
		25% power
		Flashing indicator. At least 5 minutes of available power remains.

**CAUTION**

Do not use the FLIR K series camera without the correct training. If the persons that operate the camera do not have the correct training, an incorrect analysis of the infrared images can occur. Thus, incorrect decisions during the firefighting can be made.

The training must include:

- How a thermal camera operates and its limits
- How to interpret an image
- How to work safely with the camera.

11.1 Removing the battery (FLIR K45, FLIR K55)

11.1.1 Procedure

Follow this procedure:

1. Pull the eccentric latch.



2. Pull out the battery from the battery compartment.

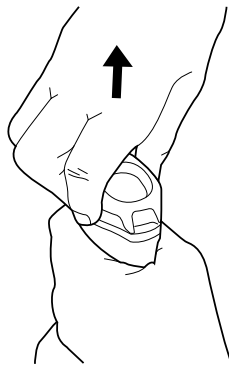

11.2 Removing the battery (FLIR K65)

11.2.1 Procedure

Follow this procedure:

1. Unscrew the Torx T20 screw and pull up the latch.

	CAUTION
Make sure that you do not use a torque value that is more than 80 Ncm on the Torx T20 screw. Damage to the camera can occur if you do not obey this.	



2. Pull out the battery from the battery compartment.



11.3 Charging the battery

11.3.1 General

Charge the battery for 4 hours before starting the camera for the first time, or until the blue battery condition LED glows continuously.

11.3.2 Procedure

Follow this procedure:

1. Put the battery in the standalone battery charger.
2. Connect the power supply cable plug to the connector on the standalone battery charger.
3. Connect the power supply mains-electricity plug to a mains socket.

-
4. Disconnect the power supply cable plug when the blue battery condition LED glows continuously.

11.4 Turning on and turning off the camera

- Push the on/off button to turn on the camera.
- Push and hold the on/off button for more than 3 seconds but less than 10 seconds to put the camera into the standby mode. The camera then automatically turns off after 6 hours.
- Push and hold the on/off button for more than 10 seconds to turn off the camera.

11.5 Selecting camera modes (FLIR K45, FLIR K55)

11.5.1 General

The FLIR K45 and FLIR K55 camera feature five different camera modes. You select the camera mode by pushing the *Mode* button.

The five different camera modes are:

1. Basic mode.
2. Black and white firefighting mode.
3. Fire mode.
4. Search and rescue mode.
5. Heat detection mode.

Each mode is optimized for a certain type of firefighting application. In addition, the modes differ in the following way:

- Modes with green icons (1–3 in the list): The camera switches between the high-sensitivity range (–20 to +150°C (–4 to +302°F)) and the low-sensitivity range (0 to +650°C (+32 to +1202°F)) automatically when objects with a temperature above 150°C (302°F) enter the field of view of the camera.
- Modes with blue icons (4–5 in the list): The temperature range is locked to the high-sensitivity range (–20 to +150°C (–4 to +302°F)). This is useful if you need to maintain the best possible image for objects with a temperature below 150°C (302°F), even if there are objects with a temperature above 150°C (302°F) in the field of view of the camera.

11.5.2 Explanation of the different camera modes

11.5.2.1 Basic mode

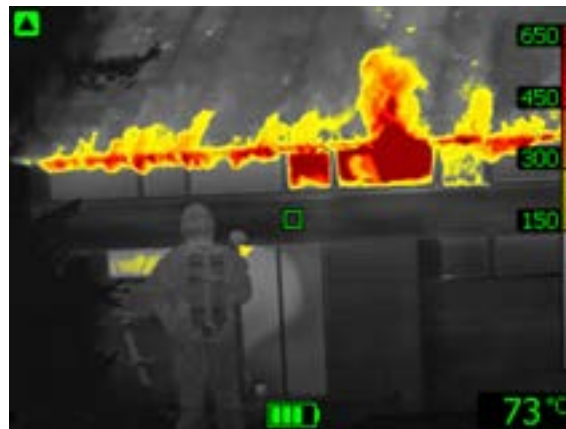

Figure 11.1 Basic mode.

The Basic mode is the default mode of the camera. It is a multipurpose mode for the initial fire attack with life rescuing operation and control of the fire. The camera automatically switches between the high-sensitivity range and the low-sensitivity range, to maintain an optimal infrared image while at the same time maintaining a safe and consistent heat colorization of the fire scene.

- Automatic range.
- Colorization of heat: +150 to +650°C (+302 to +1202°F).
- High-sensitivity range: -20 to +150°C (-4 to +302°F).
- Low-sensitivity range: 0 to +650°C (+32 to +1202°F).



NOTE

To go to the Basic mode from any other mode, push and hold the on/off button for less than 1 second.

11.5.2.2 Black and white firefighting mode



Figure 11.2 Black and white firefighting mode.

The *black and white firefighting mode* is a standardized firefighting mode based on the Basic mode. It is a multipurpose mode for the initial fire intervention that includes life rescuing operations and control of the fire. It is specifically designed for fire services that do not want to use the heat colorization feature.

The camera automatically switches between the high-sensitivity range and the low-sensitivity range, to maintain an optimal infrared image.

- Automatic range.
- High-sensitivity range: -20 to +150°C (-4 to +302°F).
- Low-sensitivity range: 0 to +650°C (+32 to +1202°F).

11.5.2.3 Fire mode

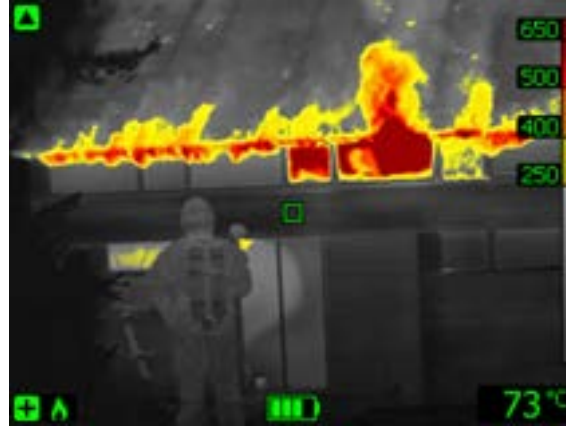

Figure 11.3 Fire mode.

The *fire mode* is similar to the Basic mode, but with a higher-temperature starting point for the heat colorization. It is suitable for fire scenes with higher background temperatures, where there are already a lot of open flames and a high background temperature. The camera automatically switches between the high-sensitivity range and the low-sensitivity range, to maintain an optimal infrared image while at the same time maintaining a safe and consistent heat colorization.

- Automatic range.
- Colorization of heat: +250 to +650°C (+ 482 to +1202°F).
- High-sensitivity range: -20 to +150°C (-4 to +302°F).
- Low-sensitivity range: 0 to +650°C (+32 to +1202°F).

11.5.2.4 Search and rescue mode

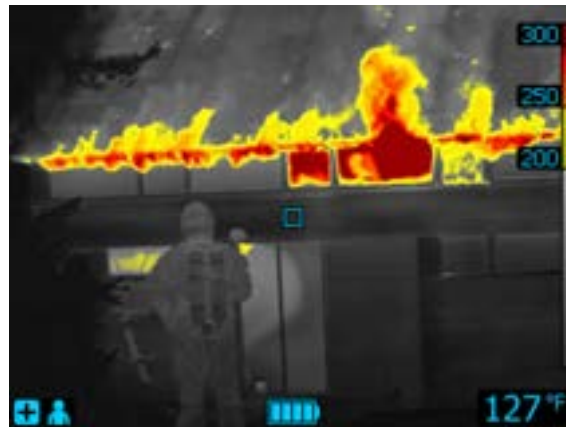

Figure 11.4 Search and rescue mode.

The *search and rescue mode* is optimized for maintaining high contrast in the infrared image while searching for people in landscapes, buildings, or traffic accident scenes.

- High-sensitivity range only.
- Colorization of heat: +100 to +150°C (+212 to +302°F).
- High-sensitivity range: -20 to +150°C (-4 to +302°F).

11.5.2.5 Heat detection mode



Figure 11.5 Heat detection mode.

The *heat detection mode* is optimized for searching hotspots during overhaul after the fire is out—typically to ensure that there is no remaining hidden fire. This mode can also be used to find thermal patterns (e.g., signs of people in car seats after accidents), to ensure that everyone has been found. This mode can also be used to search for people in water and open landscapes.

- High-sensitivity range only.
- Colorization of heat: the 20% highest temperatures in the scene.
- High-sensitivity range: -20 to $+150^{\circ}\text{C}$ (-4 to $+302^{\circ}\text{F}$).

11.6 Selecting camera modes (FLIR K65)

11.6.1 General

The FLIR K65 camera features five different camera modes. You select the camera mode by pushing the *Mode* button.

The five different camera modes are:

1. NFPA Basic mode.
2. NFPA Basic Plus black and white firefighting mode.
3. NFPA Basic Plus fire mode.
4. NFPA Basic Plus search and rescue mode.
5. NFPA Basic Plus heat detection mode.

Each mode is optimized for a certain type of firefighting application. In addition, the modes differ in the following way:

- Modes with green icons (1–3 in the list): The camera switches between the high-sensitivity range (-20 to $+150^{\circ}\text{C}$ (-4 to $+302^{\circ}\text{F}$)) and the low-sensitivity range (0 to $+650^{\circ}\text{C}$ ($+32$ to $+1202^{\circ}\text{F}$)) automatically when objects with a temperature above 150°C (302°F) enter the field of view of the camera.
- Modes with blue icons (4–5 in the list): The temperature range is locked to the high-sensitivity range (-20 to $+150^{\circ}\text{C}$ (-4 to $+302^{\circ}\text{F}$)). This is useful if you need to maintain the best possible image for objects with a temperature below 150°C (302°F), even if there are objects with a temperature above 150°C (302°F) in the field of view of the camera.

11.6.2 Explanation of the different camera modes

11.6.2.1 NFPA Basic mode

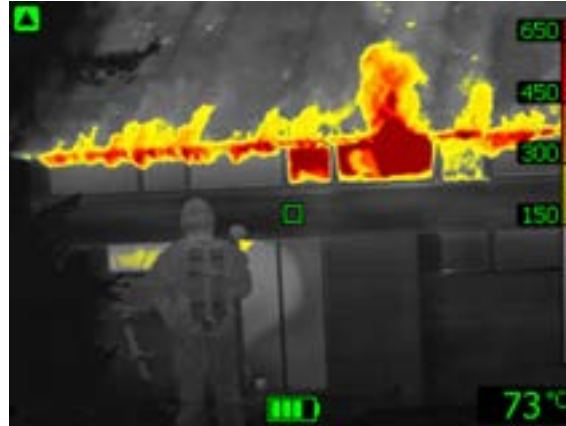

Figure 11.6 NFPA Basic mode.

The NFPA Basic mode is the default mode of the camera. It is a multipurpose mode for the initial fire attack with life rescuing operation and control of the fire. The camera automatically switches between the high-sensitivity range and the low-sensitivity range, to maintain an optimal infrared image while at the same time maintaining a safe and consistent heat colorization of the fire scene.

- Automatic range.
- Colorization of heat: +150 to +650°C (+302 to +1202°F).
- High-sensitivity range: -20 to +150°C (-4 to +302°F).
- Low-sensitivity range: 0 to +650°C (+32 to +1202°F).



NOTE

To go to NFPA Basic mode from any other mode, push and hold the on/off button for less than 1 second.

11.6.2.2 NFPA Basic Plus black and white firefighting mode



Figure 11.7 NFPA Basic Plus black and white firefighting mode.

The NFPA Basic Plus black and white firefighting mode is a standardized firefighting mode based on the NFPA Basic mode. It is a multipurpose mode for the initial fire intervention

that includes life rescuing operations and control of the fire. It is specifically designed for fire services that do not want to use the heat colorization feature.

The camera automatically switches between the high-sensitivity range and the low-sensitivity range, to maintain an optimal infrared image.

- Automatic range.
- High-sensitivity range: -20 to $+150^{\circ}\text{C}$ (-4 to $+302^{\circ}\text{F}$).
- Low-sensitivity range: 0 to $+650^{\circ}\text{C}$ ($+32$ to $+1202^{\circ}\text{F}$).

11.6.2.3 NFPA Basic Plus fire mode

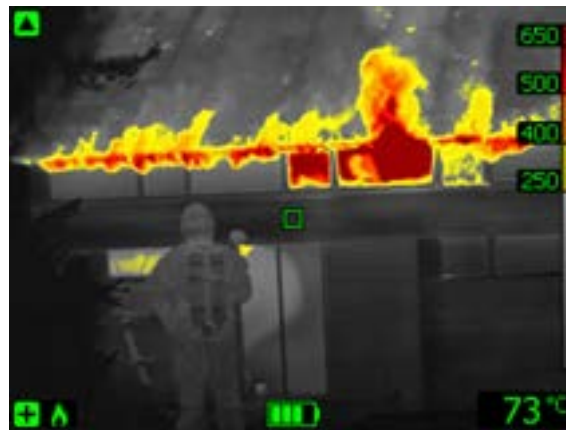

Figure 11.8 NFPA Basic Plus fire mode.

The NFPA Basic Plus fire mode is similar to the NFPA Basic mode, but with a higher-temperature starting point for the heat colorization. It is suitable for fire scenes with higher background temperatures, where there are already a lot of open flames and a high background temperature. The camera automatically switches between the high-sensitivity range and the low-sensitivity range, to maintain an optimal infrared image while at the same time maintaining a safe and consistent heat colorization.

- Automatic range.
- Colorization of heat: $+250$ to $+650^{\circ}\text{C}$ ($+482$ to $+1202^{\circ}\text{F}$).
- High-sensitivity range: -20 to $+150^{\circ}\text{C}$ (-4 to $+302^{\circ}\text{F}$).
- Low-sensitivity range: 0 to $+650^{\circ}\text{C}$ ($+32$ to $+1202^{\circ}\text{F}$).

11.6.2.4 NFPA Basic Plus search and rescue mode



Figure 11.9 NFPA Basic Plus search and rescue mode.

The NFPA Basic Plus search and rescue mode is optimized for maintaining high contrast in the infrared image while searching for people in landscapes, buildings, or traffic accident scenes.

- High sensitivity range only.
- Colorization of heat: +100 to +150°C (+212 to +302°F).
- High-sensitivity range: -20 to +150°C (-4 to +302°F).

11.6.2.5 NFPA Basic Plus heat detection mode



Figure 11.10 NFPA Basic Plus heat detection mode

The NFPA Basic Plus heat detection mode is optimized for searching hotspots during overhaul after the fire is out—typically to ensure that there is no remaining hidden fire. This mode can also be used to find thermal patterns (e.g., signs of people in car seats after accidents), to ensure that everyone has been found. This mode can also be used to search for people in water and open landscapes.

- High-sensitivity range only.
- Colorization of heat: the 20% highest temperatures in the scene.
- High-sensitivity range: -20 to +150°C (-4 to +302°F).

11.7 Saving an image

11.7.1 General

You can save images to the camera's archive.



NOTE

The maximum number of images that can be saved in the archive is 200. When the number of images exceeds 200, images are deleted on a *first-in, first-out basis*, i.e., the 201st image will delete the 1st image, the 202nd image will delete the 2nd image, and so on.

11.7.2 Figure

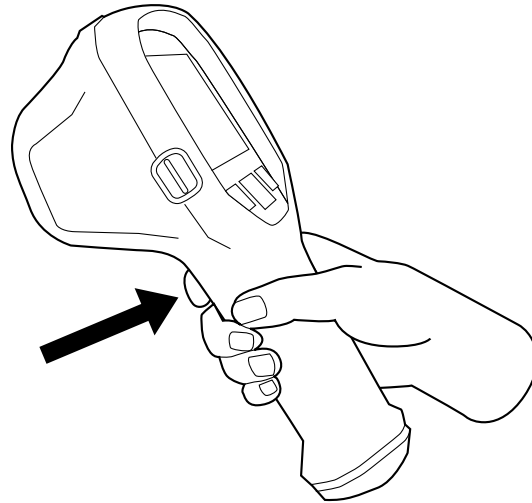

11.7.3 Procedure

Follow this procedure:

1. Aim the camera toward an object of interest.
2. To save an image, pull the trigger.

11.8 Recording a video clip

11.8.1 General

You can record video clips and save them to the camera's archive.



NOTE

You must change the behavior of the Save trigger on the *User interface* tab.

11.8.2 Figure

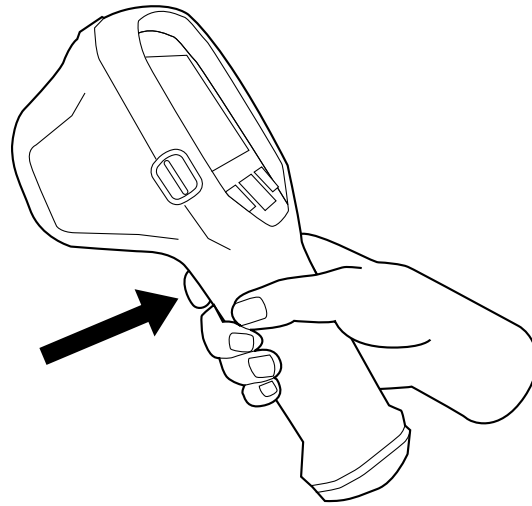

11.8.3 Procedure

Follow this procedure:

1. Aim the camera toward an object of interest.
2. Do the following:
 - To start the recording, pull and hold the trigger. A blinking circle in the middle left part of the screen indicates that the camera is currently recording a video clip.
 - To stop the recording, release the trigger.

11.9 Connecting the camera to a computer

11.9.1 General

You can connect the camera to a computer, using the USB cable. Once connected, you can move the images from the camera's archive to the computer. You can also import the images into the FLIR Tools software. A download card for FLIR Tools is included in the transport case.

11.9.2 Procedure (FLIR K45, FLIR K55)

Follow this procedure:

1. Fold up the rubber cover at the top of the camera.

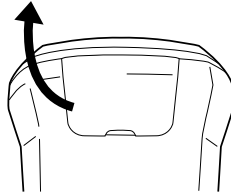

2. Hold the metal ring firmly.

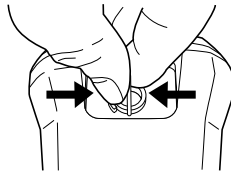

3. Rotate the ring about 90° counter-clockwise.

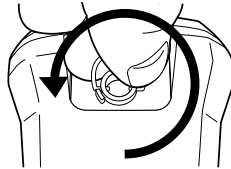

4. Pull out the plastic insert.

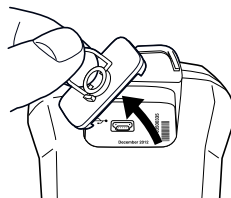
**CAUTION**

The plastic insert has an O-ring seal. Do not damage the O-ring seal.

-
5. Connect the USB cable to the USB Mini-B connector in the connector bay.

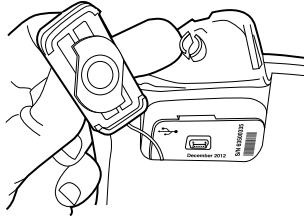

6. Do one of the following:
 - Move the images to the computer using a drag-and-drop operation in Microsoft Windows Explorer.

**NOTE**

Moving an image using a drag-and-drop operation does not delete the image in the camera.

- Move the images to the computer using FLIR Tools.

11.9.3 Procedure (FLIR K65)

Follow this procedure:

1. Fold up the rubber cover at the top of the camera.

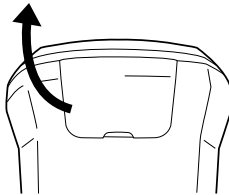

2. Fold up the metal ring.

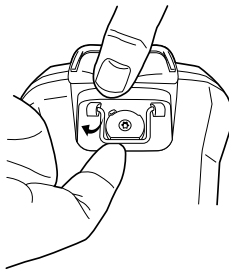

3. Unscrew the Torx T20 screw.

**CAUTION**

Make sure that you do not use a torque value that is more than 80 Ncm on the Torx T20 screw. Damage to the camera can occur if you do not obey this.

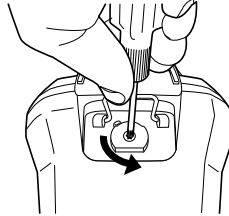

4. Pull out the plastic insert.

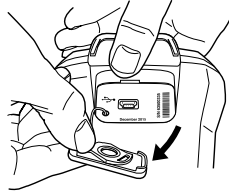
**CAUTION**

The plastic insert has an O-ring seal. Do not damage the O-ring seal.

5. Connect the USB cable to the USB Mini-B connector in the connector bay.

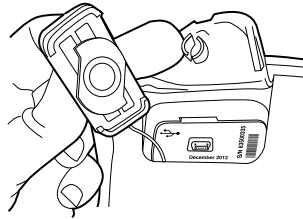

6. Do one of the following:

- Move the images to the computer using a drag-and-drop operation in Microsoft Windows Explorer.

**NOTE**

Moving an image using a drag-and-drop operation does not delete the image in the camera.

- Move the images to the computer using FLIR Tools.

11.10 Viewing saved images

11.10.1 General

When you save an image, the image is stored in the camera's archive. To display the image again, you can recall it from the archive.

11.10.2 Procedure

Follow this procedure:

1. While holding down the *Mode* button, push the *Zoom* button. This displays the screen below.



2. Select *Archive* by pushing the *Mode* button. This displays the screen below.

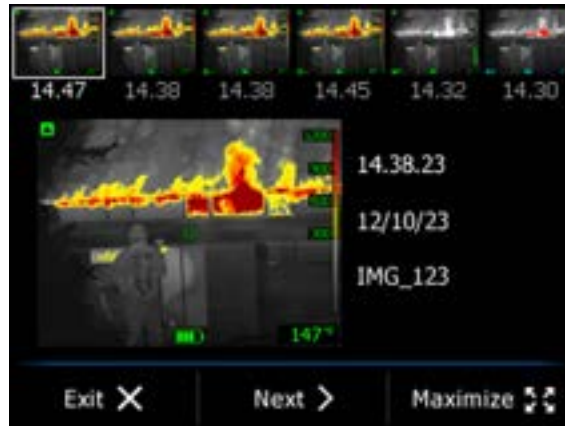

3. In the archive, do one of the following:
 - Select *Next* by pushing the *Mode* button to navigate in the archive.
 - Select *Maximize* by pushing the *Zoom* button to enlarge a specific image.
4. Select *Exit* by pushing the *On/off* button to exit the archive.

11.11 Viewing saved video clips

11.11.1 General

When you save a video clip, it is stored in the camera's archive. To view the video clip, you can recall it from the archive.

11.11.2 Procedure

Follow this procedure:

1. Push and hold the *Mode* button, then push the *Zoom* button. This displays the screen below.



2. Select *Archive* by pushing the *Mode* button.
3. Select the video clip by pushing the *Mode* button. Video clips are indicated by a film-strip icon. See the screen below.

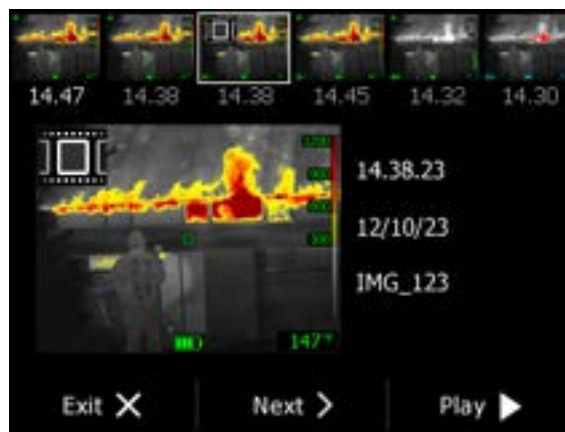

4. Do the following:
 - To start viewing the video clip, push and hold the *Zoom* button.
 - To stop viewing the video clip, release the *Zoom* button.
5. Select *Exit* by pushing the *On/off* button to exit the archive.

11.12 Changing settings (in the camera)

11.12.1 General

You can change a variety of settings. These settings include the following:

- Temperature unit.
- Temperature indication.
- Date.
- Time.
- Factory default settings.

11.12.2 Procedure

Follow this procedure:

1. Push and hold the *Mode* button, then push the *Zoom* button. This displays the screen below.



2. Select *Settings* by pushing the *Zoom* button. This displays the screen below.



3. Select *Next* by pushing the *Mode* button to navigate to the parameter that you want to change.
4. Select *Adjust* by pushing the *Zoom* button to change the value.
5. Select *Exit* by pushing the *On/off* button to confirm the choice and exit the dialog box.

11.13 Changing settings (in FLIR Tools)

11.13.1 The General settings tab

11.13.1.1 Figure

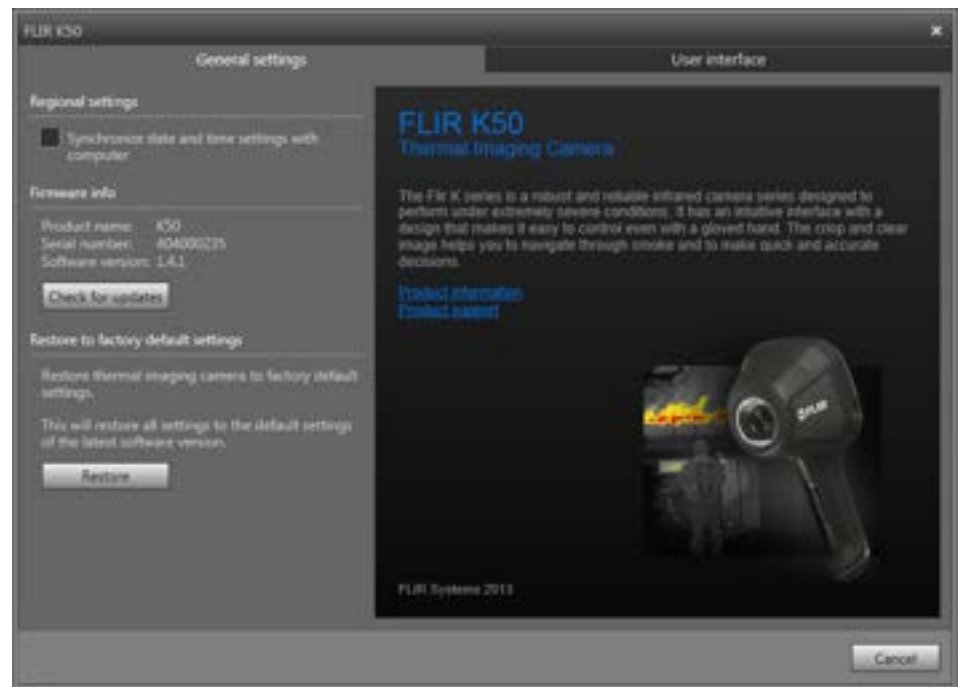

11.13.1.2 Explanation

Regional settings area: To synchronize the camera's date and time settings with the computer, select the checkbox.

Firmware info area: To check whether a newer version of the camera firmware exists, click *Check for updates*, and follow the on-screen instructions.

Restore to factory default area: To restore all camera settings to the factory defaults, click *Restore*.

11.13.2 The User interface tab

11.13.2.1 Figure

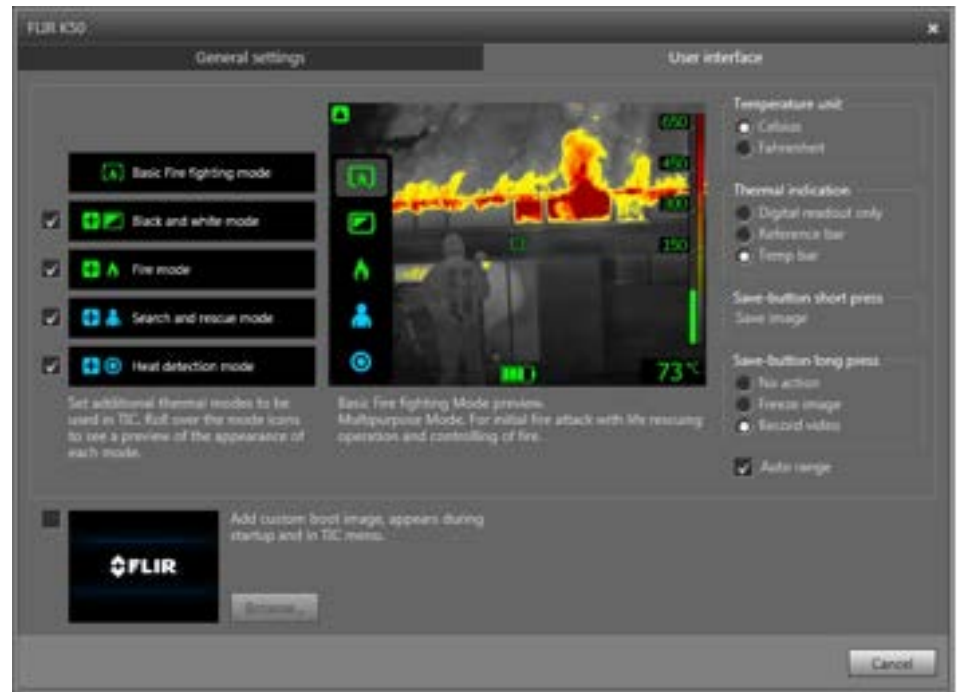

11.13.2.2 Explanation

Camera modes area: To define which camera modes to enable in the camera, select the camera mode. For more information on each camera mode, see section 11.5.2 *Explanation of the different camera modes*, page 24.

Temperature unit area: To select a different temperature unit, click *Celsius* or *Fahrenheit*.

Thermal indication area > Digital readout only: To display the thermal information in the image as the temperature of the spotmeter only, select *Digital readout only*. In modes with automatic heat colorization, the colorization of the image will remain but the static heat color reference icon will not be displayed.

Thermal indication area > Reference bar: In modes with automatic heat indication colorization, a vertical heat color reference bar is displayed in the thermal indication area. This static icon shows how heat colors are applied to the range of the camera mode. The colors yellow, orange, and red correspond to a temperature-dependent change in hue as the temperature increases.

Thermal indication area > Temp bar: To display the thermal information in the image as a temperature bar, similar to a thermometer, click *Temp bar*. This displays a dynamic vertical temperature bar on the right-hand side of the image. The top of the dynamic bar represents the temperature of the measured spot. In modes with automatic heat colorization, the colorization of the image will remain, with a static heat color reference icon displayed next to the temp bar.

Save-button long press area > No action: To unassign any functionality, select *No action*.

Save-button long press area > Freeze image: To make the camera freeze the image, select *Freeze image*. The image unfreezes when the Save button is released.

Auto range: To make the camera automatically switch between the low-temperature range and the high-temperature range, depending on the scene temperature, select *Auto range*. The temperature level at which the camera switches between the two modes is +150°C (+302°F). If *Auto range* is not selected, the camera works in the high-temperature range only. This has the advantage that the camera does not perform a non-uniformity correction when an object with a temperature higher than +150°C (+302°F) enters the scene. However, the disadvantage is lower sensitivity and a higher level of signal noise.

Save-button long press area > Record video: To make the camera start a recording, select *Record video*. The recording stops when the Save button is released.

Add custom boot image area: To specify your own unique image to appear during start-up, click *Browse*, and navigate to the image file. This is useful for, for example, identifying your fire department's cameras. By incorporating your fire department's logo, and a unique identity number in the image, you can keep track of your cameras. This image can also be accessed from the camera menu.

In-truck charger (optional accessory)

12.1 Introduction



Thank you for choosing the FLIR Kxx series in-truck charger from FLIR Systems.

The in-truck charger is intended to be mounted on a flat surface in the cab, in one of the equipment lockers, or in another suitable compartment on the fire engine. The in-truck charger has five ports for cable routing—one through the rear of the metal bracket and one port on each side of the in-truck charger.

The in-truck charger can also be powered using a standard FLIR Systems power supply, and has a battery charger located at the lower front of the unit.

12.2 Parts and functions

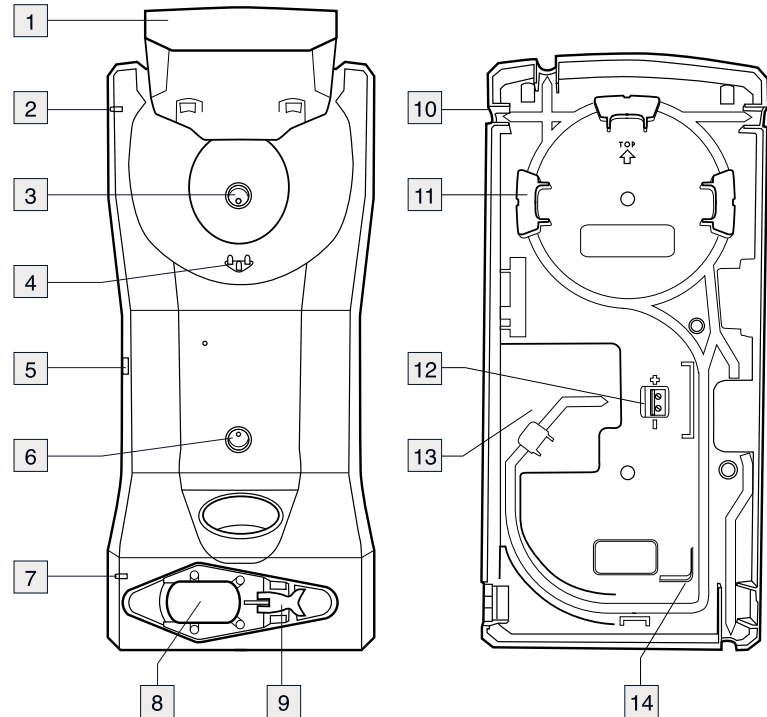

1. Top cover.
2. LED indicator for the camera charger.
3. Hole for attaching the charger housing to the metal bracket.
4. Connectors in the cradle.
5. Connector to power the charger using a standard FLIR Systems power supply.
6. Hole for attaching the charger housing to the metal bracket.
7. LED indicator for the battery charger.
8. Battery slot.
9. Eccentric latch to secure the battery during charging.
10. Cable port (1 of 4).
11. Routing support.
12. 12–24 VDC cable plinth.
13. Recess for the cable.
14. Routing support.

12.3 Choosing a suitable position

Before mounting the in-truck charger, take a few minutes to think about a suitable position.

The mounting position should be protected from rain and road splash, and it should be reasonably easy to install a permanent cable running from the fire engine's 12–24 VDC system to the in-truck charger.

Additional considerations may be important, e.g., getting access to panels and equipment behind the in-truck charger.

12.4 Recommended cable area and fuse

Cable area	1.5 mm ² (No. 15 AWG)
Fuse	5 A

12.5 Mounting instructions

Follow this procedure:

1. Permanently install a cable running from the fire engine's 12–24 VDC system to the selected mounting position of the in-truck charger. Do not connect this cable to the 12–24 VDC system at this time. The routing must include a fuse installed close to the battery. See above for the fuse recommendation.
2. Remove the two screws that hold the metal bracket.
3. Remove the metal bracket.
4. Use the metal bracket as a template to mark where the mounting holes should be drilled.
5. Drill the holes.
6. Mount the metal bracket using the rivets and/or screws that come with the in-truck charger.
7. Connect the cable to the cable plinth on the rear of the in-truck charger.



NOTE

Take note of the polarity when you connect the cable to the cable plinth.

8. Route the cable so that it exits through the cable port of your choice.
9. Mount the in-truck charger to the metal bracket using the two screws that you removed in Step 2 above.
10. Permanently connect the cable to the fire engine's 12–24 VDC system.

12.6 Charging the camera

Follow this procedure:

1. Pull up the top cover of the in-truck charger.
2. Push the camera into position.
3. Push down the top cover.
The charging of the camera has now started, and is finished when the blue light glows continuously. Charging a fully depleted camera takes approximately 4 hours.

12.7 Charging a battery separately

FLIR Kxx series batteries can be charged separately using the battery charger at the lower front of the unit.

Follow this procedure:

1. Pull the eccentric latch on the bottom of the camera.
2. Pull out the battery from the camera.
3. Push the battery into the slot at the lower front of the charger.
4. Secure the battery using the eccentric latch on the charger.
The charging of the battery has now started, and is finished when the blue light glows continuously. Charging a fully depleted battery takes approximately 4 hours.

12.8 Cleaning



CAUTION

Disconnect the in-truck charger from the fire engine's 12–24 VDC system before cleaning.

The in-truck charger can be cleaned using warm water or a weak detergent solution. Do not use solvents or similar liquids.

12.9 Customer support

Should you experience any problems, do not hesitate to contact our Customer Support at <http://support.flir.com>.

13.1 Online field-of-view calculator

Please visit <http://support.flir.com> and click the photo of the camera series for field-of-view tables for all lens–camera combinations.

13.2 Note about technical data

FLIR Systems reserves the right to change specifications at any time without prior notice. Please check <http://support.flir.com> for latest changes.

13.3 Note about authoritative versions

The authoritative version of this publication is English. In the event of divergences due to translation errors, the English text has precedence.

Any late changes are first implemented in English.

13.4 FLIR K45

P/N: 72201-0106

Rev.: 25948

General description

The FLIR K45 is a robust and reliable infrared camera designed to perform under extremely severe conditions. The FLIR K45 has an intuitive interface with a design that makes it easy to control even with a gloved hand. The crisp and clear image helps you to navigate through smoke and to make quick and accurate decisions.

Benefits:

- **Robust and reliable:** The FLIR K45 is designed to meet tough operating conditions. It can withstand a drop from 2 m (6.5 ft.) onto a concrete floor, is water resistant to IP67, and is fully operational up to +85°C (+185°F), or +260°C (+500°F) for 5 min.
- **Clear and crisp thermal images:** The maintenance-free uncooled microbolometer sensor produces clear and detail-rich images of 240 × 180 pixels which have been further improved with FSX, a digital image processing enhancement technique. Thermal images are presented on a large, bright 4" display, helping you to navigate and to make quick and accurate decisions.
- **Easy-to-use—also in a gloved firefighter's hand:** An intuitive and simple user interface allows you to focus on the job. The FLIR K series can be controlled by just three large buttons on top of the unit. Ideal for a gloved firefighter's hand.

Imaging and optical data

IR resolution	240 × 180 pixels
Thermal sensitivity/NETD	< 40 mK @ +30°C (+86°F)
Field of view (FOV)	51° × 38°
Depth of field	0.84 m to infinity (33 in. to infinity)
Focal length	9 mm (0.35 in.)
Spatial resolution (IFOV)	3.6 mrad
F-number	1.25
Image frequency	60 Hz
Focus	Fixed
Zoom	2× digital zoom

Detector data

Detector type	Focal plane array (FPA), uncooled microbolometer
Spectral range	7.5–13 μm
Pitch	25 μm

Image presentation

Display	4 in. LCD, 320 × 240 pixels, backlit
Auto range	Yes, selectable on/off using FLIR Tools
Contrast optimization	Digital image enhancement using FSX

Image presentation modes	
Image modes	<ul style="list-style-type: none"> • IR image <ul style="list-style-type: none"> • TI Basic fire-fighting mode • Black-and-white fire-fighting mode • Fire mode • Search-and-rescue mode • Heat detection mode • Thumbnail gallery
Measurement	
Object temperature range	<ul style="list-style-type: none"> • -20°C to +150°C (-4°F to +302°F) • 0°C to +650°C (+32°F to +1202°F)
Accuracy	±4°C (±7.2°F) or ±4% of reading, for ambient temperature 10°C to 35°C (+50°F to 95°F)
Measurement analysis	
Spotmeter	1
Automatic hot detection	Heat detection mode (the hottest 20% of the of scene is colorized)
Isotherm	Yes
Set-up	
Set-up commands	Local adaptation of units, date and time formats
Languages	English
Storage of images	
Image storage	Standard JPEG
Storage media	Internal flash memory
Image storage capacity	200 images
Image storage mode	IR only
File formats	Standard JPEG
Image annotations	
Report generation	Separate software (FLIR Tools)
Video streaming	
Non-radiometric IR video streaming	Uncompressed colorized video using USB
USB	
USB	USB Mini-B

Compatibility	
Compatible with FLIR software	FLIR Tools
Data communication interfaces	
Interfaces	<ul style="list-style-type: none"> • Update from PC and Mac devices • Data transfer to and from PC
Power system	
Battery type	Li Ion
Battery voltage	3.6 V
Battery capacity	4.4 Ah, at +20°C to +25°C (+68°F to +77°F)
Battery operating time	Approx. 4 hours at +25°C (+77°F) ambient temperature and typical use
Charging system	<ul style="list-style-type: none"> • Battery is charged inside the camera • 2-bay charger • Optional In-truck charger
Charging time	2 h to 85% capacity, charging status indicated by LEDs
Charging temperature	0°C to +45°C (+32°F to +113°F)
Power management	Automatic shutdown and sleep mode
Start-up time from sleep mode	< 4 s.
Start-up time	< 17 s. (IR image, no GUI)
Environmental data	
Operating temperature range	<ul style="list-style-type: none"> • -20°C to +85°C (-4°F to +185°F) • +150°C (+302°F): 15 min. • +260°C (+500°F): 5 min.
Storage temperature range	-40°C to +85°C (-40°F to +185°F)
Humidity (operating and storage)	IEC 60068-2-30/24 h 95% relative humidity +25°C to +40°C (+77°F to +104°F) / 2 cycles
Relative humidity	95% relative humidity +25°C to +40°C (+77°F to +104°F) non-condensing
Directives	<p>Designed to meet NFPA 1801:2013 specification:</p> <ul style="list-style-type: none"> • Vibration • Impact acceleration resistance • Corrosion • Viewing surface abrasion • Heat resistance • Heat and flame • Product label durability

Environmental data	
EMC	<ul style="list-style-type: none"> • EN 61000-6-2:2005 (Immunity) • EN 61000-6-3: 2011 (Emission) • FCC 47 CFR Part 15 B (Emission)
Magnetic fields	EN 61 000-4-8, Test level 5 for continuous field (severe industrial environment)
Encapsulation	IP 67 (IEC 60529)
Shock	25 g (IEC 60068-2-27)
Vibration	2 g (IEC 60068-2-6)
Drop	2 m (6.6 ft.) on concrete floor (IEC 60068-2-31)
Safety (power supply)	CE/EN/UL/CSA/PSE 60950-1

Physical data	
Camera weight, incl. battery	1.1 ±0.05 kg (2.4 ±0.1 lb.)
Battery weight	0.152 kg (0.3 lb.)
Camera size (L × W × H)	120 × 125 × 280 mm (4.7 × 4.9 × 11 in.)
Tripod mounting	UNC ¼"-20 (adapter needed)
Material	<ul style="list-style-type: none"> • PPSU • Silicon rubber • Aluminium, cast • Flame-resistant magnesium alloy

Shipping information	
List of contents	<ul style="list-style-type: none"> • Infrared camera • Battery (2 ea.) • Battery charger • Hard transport case • Lanyard strap • Neck strap • Power supply • Printed documentation • Retractable lanyard • Tripod adapter • USB cable • User documentation CD-ROM
Packaging, weight	5.7 kg (12.6 lb.)
Packaging, size	500 × 190 × 370 mm (19.7 × 7.5 × 14.6 in.)
EAN-13	4743254002005
UPC-12	845188010898
Country of origin	Estonia

Supplies and accessories:

- 1910423; USB cable Std A <-> Mini-B
- T198509; Cigarette lighter adapter kit, 12 VDC, 1.2 m/3.9 ft.
- T198125; Battery charger, incl. power supply with multi plugs (Exx, Kxx)
- T198322; In-truck charger
- T198310ACC; Li-Ion Battery pack 3.6 V 16 Wh
- T127724ACC; Neck strap
- T127722ACC; Retractable lanyard
- T198416ACC; Strap lanyard
- T198457ACC; Tripod Adapter, Kxx
- T198441ACC; Transport case Kxx

13.5 FLIR K55

P/N: 72201-0206

Rev.: 25949

General description

The FLIR K55 is a robust and reliable infrared camera designed to perform under extremely severe conditions. The FLIR K55 has an intuitive interface with a design that makes it easy to control even with a gloved hand. The crisp and clear image helps you to navigate through smoke and to make quick and accurate decisions.

Benefits:

- Robust and reliable: The FLIR K55 is designed to meet tough operating conditions. It can withstand a drop from 2 m (6.5 ft.) onto a concrete floor, is water resistant to IP67, and is fully operational up to +85°C (+185°F), or +260°C (+500°F) for 5 min.
- Clear and crisp thermal images: The maintenance-free uncooled microbolometer sensor produces clear and detail-rich images of 320 × 240 pixels which have been further improved with FSX, a digital image processing enhancement technique. Thermal images are presented on a large, bright 4" display, helping you to navigate and to make quick and accurate decisions.
- Easy-to-use—also in a gloved firefighter's hand: An intuitive and simple user interface allows you to focus on the job. The FLIR K series can be controlled by just three large buttons on top of the unit. Ideal for a gloved firefighter's hand.
- Recording

Imaging and optical data	
IR resolution	320 × 240 pixels
Thermal sensitivity/NETD	< 30 mK @ +30°C (+86°F)
Field of view (FOV)	51° × 38°
Depth of field	0.84 m to infinity (33 in. to infinity)
Focal length	9 mm (0.35 in.)
Spatial resolution (IFOV)	2.8 mrad
F-number	1.25
Image frequency	60 Hz
Focus	Fixed
Zoom	2× digital zoom

Detector data	
Detector type	Focal plane array (FPA), uncooled microbolometer
Spectral range	7.5–13 μm
Pitch	25 μm

Image presentation	
Display	4 in. LCD, 320 × 240 pixels, backlit
Auto range	Yes, selectable on/off using FLIR Tools
Contrast optimization	Digital image enhancement using FSX



Image presentation modes	
Image modes	<ul style="list-style-type: none"> • IR image <ul style="list-style-type: none"> • TI Basic fire-fighting mode • Black-and-white fire-fighting mode • Fire mode • Search-and-rescue mode • Heat detection mode • Thumbnail gallery

Measurement	
Object temperature range	<ul style="list-style-type: none"> • -20°C to +150°C (-4°F to +302°F) • 0°C to +650°C (+32°F to +1202°F)
Accuracy	±4°C (±7.2°F) or ±4% of reading, for ambient temperature 10°C to 35°C (+50°F to 95°F)

Measurement analysis	
Spotmeter	1
Automatic hot detection	Heat detection mode (the hottest 20% of the of scene is colorized)
Isotherm	Yes

Set-up	
Set-up commands	Local adaptation of units, date and time formats
Languages	English

Storage of images	
Image storage	Standard JPEG
Storage media	Internal flash memory

Storage of images	
Image storage capacity	200 files in total <div style="border: 1px solid black; padding: 2px;">  NOTE The total number of files is co-dependent on the number of saved video clips. </div> Image storage mode IR only File formats Standard JPEG
Image annotations	
Report generation	Separate software (FLIR Tools)
Video recording in camera	
Non-radiometric IR video recording	MPEG-4 to internal flash memory
Storage capacity	200 files in total, with a maximum duration of 5 minutes each. <div style="border: 1px solid black; padding: 2px;">  NOTE The total number of files is co-dependent on the number of saved images. </div>
Video streaming	
Non-radiometric IR video streaming	Uncompressed colorized video using USB
USB	
USB	USB Mini-B
Compatibility	
Compatible with FLIR software	FLIR Tools
Data communication interfaces	
Interfaces	<ul style="list-style-type: none"> • Update from PC and Mac devices • Data transfer to and from PC
Power system	
Battery type	Li Ion
Battery voltage	3.6 V
Battery capacity	4.4 Ah, at +20°C to +25°C (+68°F to +77°F)
Battery operating time	Approx. 4 hours at +25°C (+77°F) ambient temperature and typical use

Power system	
Charging system	<ul style="list-style-type: none"> • Battery is charged inside the camera • 2-bay charger • Optional In-truck charger
Charging time	2 h to 85% capacity, charging status indicated by LEDs
Charging temperature	0°C to +45°C (+32°F to +113°F)
Power management	Automatic shutdown and sleep mode
Start-up time from sleep mode	< 4 s.
Start-up time	< 17 s. (IR image, no GUI)

Environmental data	
Operating temperature range	<ul style="list-style-type: none"> • -20°C to +85°C (-4°F to +185°F) • +150°C (+302°F): 15 min. • +260°C (+500°F): 5 min.
Storage temperature range	-40°C to +85°C (-40°F to +185°F)
Humidity (operating and storage)	IEC 60068-2-30/24 h 95% relative humidity +25°C to +40°C (+77°F to +104°F) / 2 cycles
Relative humidity	95% relative humidity +25°C to +40°C (+77°F to +104°F) non-condensing
Directives	<p>Designed to meet NFPA 1801:2013 specification:</p> <ul style="list-style-type: none"> • Vibration • Impact acceleration resistance • Corrosion • Viewing surface abrasion • Heat resistance • Heat and flame • Product label durability
EMC	<ul style="list-style-type: none"> • EN 61000-6-2:2005 (Immunity) • EN 61000-6-3: 2011 (Emission) • FCC 47 CFR Part 15 B (Emission)
Magnetic fields	EN 61 000-4-8, Test level 5 for continuous field (severe industrial environment)
Encapsulation	IP 67 (IEC 60529)
Shock	25 g (IEC 60068-2-27)
Vibration	2 g (IEC 60068-2-6)
Drop	2 m (6.6 ft.) on concrete floor (IEC 60068-2-31)
Safety (power supply)	CE/EN/UL/CSA/PSE 60950-1

Physical data	
Camera weight, incl. battery	1.1 ±0.05 kg (2.4 ±0.1 lb.)
Battery weight	0.152 kg (0.3 lb.)
Camera size (L × W × H)	120 × 125 × 280 mm (4.7 × 4.9 × 11 in.)
Tripod mounting	UNC ¼"-20 (adapter needed)
Material	<ul style="list-style-type: none"> • PPSU • Silicon rubber • Aluminium, cast • Flame-resistant magnesium alloy

Shipping information	
List of contents	<ul style="list-style-type: none"> • Infrared camera • Battery (2 ea.) • Battery charger • Hard transport case • Lanyard strap • Neck strap • Power supply • Printed documentation • Retractable lanyard • Tripod adapter • USB cable • User documentation CD-ROM
Packaging, weight	5.7 kg (12.6 lb.)
Packaging, size	500 × 190 × 370 mm (19.7 × 7.5 × 14.6 in.)
EAN-13	4743254002012
UPC-12	845188010904
Country of origin	Estonia

Supplies and accessories:

- 1910423; USB cable Std A <-> Mini-B
- T198509; Cigarette lighter adapter kit, 12 VDC, 1.2 m/3.9 ft.
- T198125; Battery charger, incl. power supply with multi plugs (Exx, Kxx)
- T198322; In-truck charger
- T198310ACC; Li-Ion Battery pack 3.6 V 16 Wh
- T127724ACC; Neck strap
- T127722ACC; Retractable lanyard
- T198416ACC; Strap lanyard
- T198457ACC; Tripod Adapter, Kxx
- T198441ACC; Transport case Kxx

13.6 FLIR K65

P/N: 72202-0303

Rev.: 26406

General description

The FLIR K65 is a robust and reliable infrared camera designed to perform under extremely severe conditions. The FLIR K65 has an intuitive interface with a design that makes it easy to control even with a gloved hand. The crisp and clear image helps you to navigate through smoke and to make quick and accurate decisions.

Benefits:

- Compliance with NFPA 1801-2013.
- Robust and reliable: The FLIR K65 is designed to meet tough operating conditions. It can withstand a drop from 2 m (6.5') onto a concrete floor, is water resistant to IP67, and is fully operational up to 85°C (185°F), and operational up to +150°C (+302°F) for 15 minutes, and +260°C (+500°F) for 5 minutes.
- Clear and crisp thermal images: The maintenance-free uncooled microbolometer sensor produces clear and detail-rich images of 320 × 240 pixels which have been further improved with FSX, a digital image-processing enhancement technique. Thermal images are presented on a large, bright 4" display, helping you to navigate and to make quick and accurate decisions.
- Easy-to-use—also in a gloved firefighter's hand: An intuitive and simple user interface allows you to focus on the job. The FLIR K series can be controlled by just three large buttons on top of the unit. Ideal for a gloved firefighter's hand.
- Recording.

Imaging and optical data	
IR resolution	320 × 240 pixels
Thermal sensitivity/NETD	< 30 mK @ +30°C (+86°F)
Field of view (FOV)	51° × 38°
Depth of field	0.84 m to infinity (33 in. to infinity)
Focal length	9 mm (0.35 in.)
Spatial resolution (IFOV)	2.8 mrad
F-number	1.25
Image frequency	60 Hz
Focus	Fixed
Zoom	2× digital zoom

Detector data	
Detector type	Focal plane array (FPA), uncooled microbolometer
Spectral range	7.5–13 μm
Pitch	25 μm

Image presentation	
Display	4 in. LCD, 320 × 240 pixels, backlit
Auto range	Yes, selectable on/off using FLIR Tools
Contrast optimization	Digital image enhancement using FSX



Image presentation modes	
Image modes	<ul style="list-style-type: none"> • IR image <ul style="list-style-type: none"> • TI Basic NFPA fire-fighting mode • Black-and-white fire-fighting mode • Fire mode • Search-and-rescue mode • Heat detection mode • Thumbnail gallery



Measurement	
Object temperature range	<ul style="list-style-type: none"> • -20°C to +150°C (-4°F to +302°F) • 0°C to +650°C (+32°F to +1202°F)
Accuracy	±4°C (±7.2°F) or ±4% of reading, for ambient temperature 10°C to 35°C (+50°F to 95°F)

Measurement analysis	
Spotmeter	1
Automatic hot detection	Heat detection mode (the hottest 20% of the of scene is colorized)
Isotherm	Yes, according to NFPA

Set-up	
Set-up commands	Local adaptation of units, date and time formats
Languages	English

Storage of images	
Image storage	Standard JPEG
Storage media	Internal flash memory

Storage of images	
Image storage capacity	200 files in total <div style="border: 1px solid black; padding: 2px;">  NOTE The number of files is co-dependent on the number of saved video clips. </div> Image storage mode IR only File formats Standard JPEG
Image annotations	
Report generation	Separate software (FLIR Tools)
Video recording in camera	
Non-radiometric IR video recording	MPEG-4 to internal flash memory
Storage capacity	200 files in total, with a maximum duration of 5 minutes each. <div style="border: 1px solid black; padding: 2px;">  NOTE The total number of files is co-dependent on the number of saved images. </div>
Video streaming	
Non-radiometric IR video streaming	Uncompressed colorized video using USB
USB	
USB	USB Mini-B
Compatibility	
Compatible with FLIR software	FLIR Tools
Data communication interfaces	
Interfaces	<ul style="list-style-type: none"> • Update from PC and Mac devices • Data transfer to and from PC
Power system	
Battery type	Li Ion
Battery voltage	3.6 V
Battery capacity	4.4 Ah, at +20°C to +25°C (+68°F to +77°F)

Power system			
Battery operating time	<p>Approx. 4 hours at +25°C (+77°F) ambient temperature and typical use.</p> <table border="1"> <tr> <td> NOTE</td> </tr> <tr> <td>This operating time is independent of camera mode.</td> </tr> </table> <p>Charging system</p> <ul style="list-style-type: none"> • Battery is charged inside the camera • 2-bay charger • Optional In-truck charger <p>Charging time</p> <p>2 h to 85% capacity, charging status indicated by LEDs</p> <p>Charging temperature</p> <p>0°C to +45°C (+32°F to +113°F)</p> <p>Power management</p> <p>Automatic shutdown and sleep mode</p> <p>Start-up time from sleep mode</p> <p>< 4 s.</p> <p>Start-up time</p> <p>< 17 s. (IR image, no GUI)</p>	 NOTE	This operating time is independent of camera mode.
 NOTE			
This operating time is independent of camera mode.			
Environmental data			
Operating temperature range	<ul style="list-style-type: none"> • -20°C to +85°C (-4°F to +185°F) • +150°C (+302°F): 15 min. • +260°C (+500°F): 5 min. 		
Storage temperature range	-40°C to +85°C (-40°F to +185°F)		
Humidity (operating and storage)	IEC 60068-2-30/24 h 95% relative humidity +25°C to +40°C (+77°F to +104°F) / 2 cycles		
Relative humidity	95% relative humidity +25°C to +40°C (+77°F to +104°F) non-condensing		
Directives	<p>Certified according to NFPA1801:2013 specification:</p> <ul style="list-style-type: none"> • Vibration • Impact acceleration resistance • Corrosion • Viewing surface abrasion • Heat resistance • Heat and flame • Product label durability 		

Environmental data	
EMC	<ul style="list-style-type: none"> • EN 61000-6-2:2005 (Immunity) • EN 61000-6-3: 2011 (Emission) • FCC 47 CFR Part 15 B (Emission)
Magnetic fields	EN 61 000-4-8, Test level 5 for continuous field (severe industrial environment)
Encapsulation	IP 67 (IEC 60529)
Shock	25 g (IEC 60068-2-27)
Vibration	2 g (IEC 60068-2-6)
Drop	2 m (6.6 ft.) on concrete floor (IEC 60068-2-31)
Safety (power supply)	CE/EN/UL/CSA/PSE 60950-1

Certifications	
Compliance	NFPA1801:2013

Physical data	
Camera weight, incl. battery	1.1 ±0.05 kg (2.4 ±0.1 lb.)
Battery weight	0.152 kg (0.3 lb.)
Camera size (L × W × H)	120 × 125 × 280 mm (4.7 × 4.9 × 11 in.)
Tripod mounting	UNC ¼"-20 (adapter needed)
Material	<ul style="list-style-type: none"> • PPSU • Silicon rubber • Aluminium, cast • Flame-resistant magnesium alloy

Shipping information	
List of contents	<ul style="list-style-type: none"> • Infrared camera • Battery (2 ea.) • Battery charger • Hard transport case • Power supply • Printed documentation • USB cable • User documentation CD-ROM
Packaging, weight	5.7 kg (12.6 lb.)
Packaging, size	500 × 190 × 370 mm (19.7 × 7.5 × 14.6 in.)
EAN-13	4743254001992
UPC-12	845188010881
Country of origin	Estonia

13.7 In-truck charger

P/N: T198322
Rev.: 23306

Power system	
Charging time	< 4 hours
Charging temperature	0°C to +45°C (+32°F to +113°F)
External power, connector type	Screw terminal or HRS_UK60-3PT
DC operation	12/ 24 V DCnominal (11.1 - 28.0 V DC)
Power	Max 36 Watts or 3000 mA at 12 VDC (5 amps fuse)

Environmental data	
Operating temperature range	-40°C to +85°C (-40°F to +185°F)
Storage temperature range	-40°C to +85°C (-40°F to +185°F)
Relative humidity	Operational for non-condensing humidity between 5% and 95%.
EMC	<ul style="list-style-type: none"> • EN61000-6-3 Emission • EN61000-6-2 Immunity • FCC47CFR part 15 class B • NFPA requirements • ISO 7637-2 Road vehicles - Electrical disturbances from conduction and coupling Part 2: Electrical transient conduction along supply lines only
Encapsulation	IP 20
Bump	Operational after exposed to: 5 pulses/ in each axis/ direction (30 total) of 30g 11ms half sine profile
Vibration	Operational after exposed to: 4, 3g rms random profile. 8 hours in each axis.

Physical data	
Weight	1.050 kg
Size (L x W x H)	380 mm x 180 mm x 153 mm (15 in. x 7.1 in. x 6 in.)
Material	PC / ABS
Color	Grey / black

Shipping information	
List of contents	<ul style="list-style-type: none"> • Charger • Documentation • Card board box
Packaging, weight	3.2 kg (7.0 lb.)
Packaging, size	435 × 245 × 167 mm (17.1 × 9.6 × 6.6 in.)
EAN-13	7332558005446 4743254001282 (Estonia plant)
UPC-12	845188005368
Country of origin	Estonia

Compatible with the following products

- 72201-0106; FLIR K45
- 72201-0206; FLIR K55

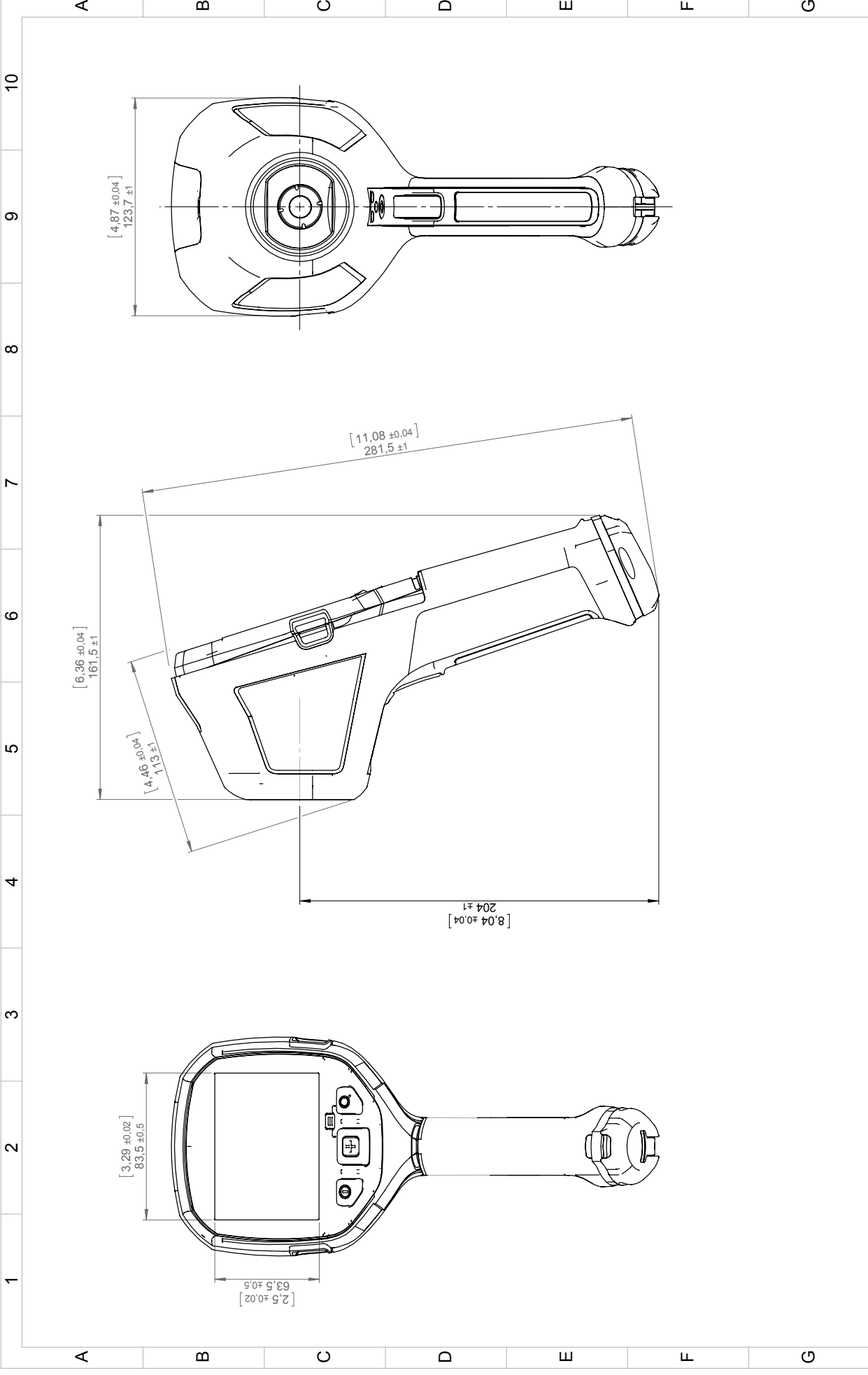

FLIR	Sheet 1(2)	Size A3	Rev
Scale 1:2	Blind	Blind	Blind
AINO.	AINO.	AINO.	AINO.
Rein nr/Drawing No T127798			

Konstruktör P. MARCUS	Datum/Date 2013-01-23	KontrollCheck -	Material -
Ändrad av/Modified by P. MARCUS	Ändrad/Modified 2013-01-23	Ytjämnhet/Roughness Ra	Ytbehandling/Surface treatment -
Överens ISO 2768-mK	Benämning/Denomination Basic dimension drawing		
Övergripande/Concept from ISO 2768-m	<ul style="list-style-type: none"> 0,5-6 ±0,1 Filter radii (30)-120 ±0,3 (120)-400 ±0,5 Kanter brutna (400)-1000 ±0,8 Edges broken 		

Den här handling är ett tekniskt dokument. Den ska användas som vägledning vid tillverkning och underhåll. För ytterligare information kontakta FLIR SYSTEMS AB. Detta dokument får inte kopieras eller spridas utan tillstånd från FLIR SYSTEMS AB. Any infringement will lead to legal proceedings.

Den här handling är ett tekniskt dokument. Den ska användas som vägledning vid tillverkning och underhåll. För ytterligare information kontakta FLIR SYSTEMS AB. Detta dokument får inte kopieras eller spridas utan tillstånd från FLIR SYSTEMS AB. Any infringement will lead to legal proceedings.

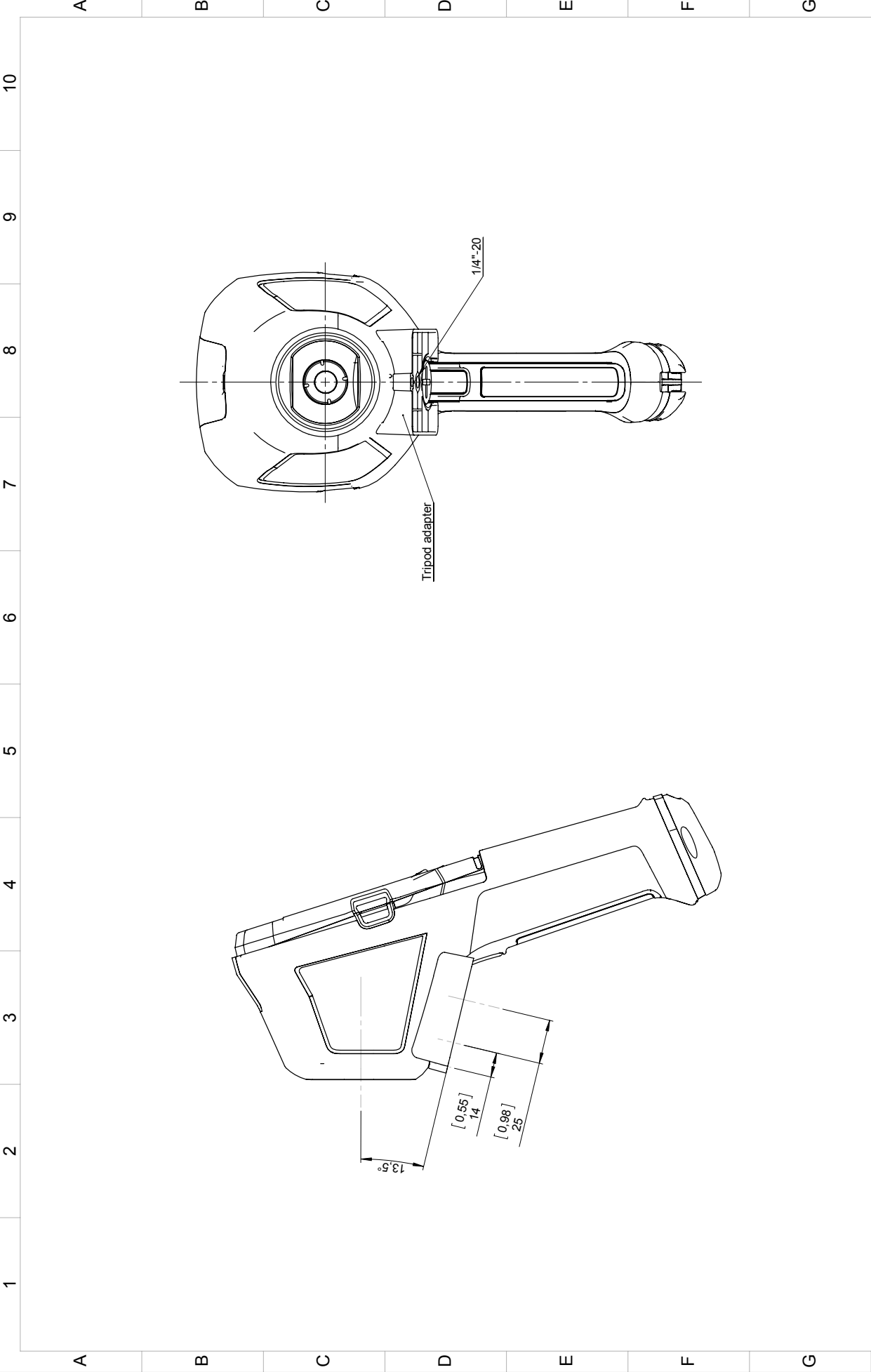

Konstr/Drawing	P. MARCUS		Datum/Date	2013-01-23	Kontroll/Check	-	Material	-
Ändrad av/Modified by	P. MARCUS		Ändrad/Modified	2013-01-23	Ytjämnhet/Roughness	Ra	Ytbehandling/Surface treatment	
Genetol ISO 2768-mK	Ultrage ut/Except from ISO 2768-m		Benämning/Denomination		Skala/Scale	1:2	Bladd/Sheet	2(2)
0,55	40,1	Hållålsradier			AITNo.		Size	A3
(30)-120	40,3	Fläkt radi			Ritn nr/Drawing No		Rev	T127798
(40)-400	40,5	Kentor brutna						
(40)-1600	40,6	Äggar broden						

Basic dimension drawing



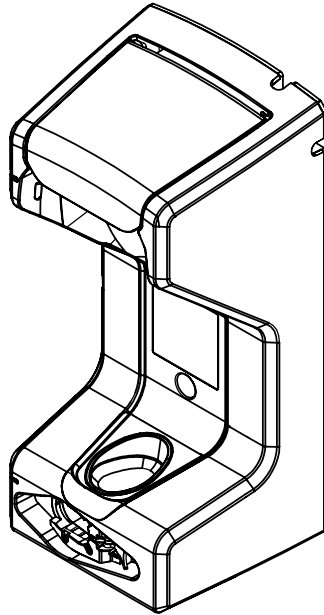
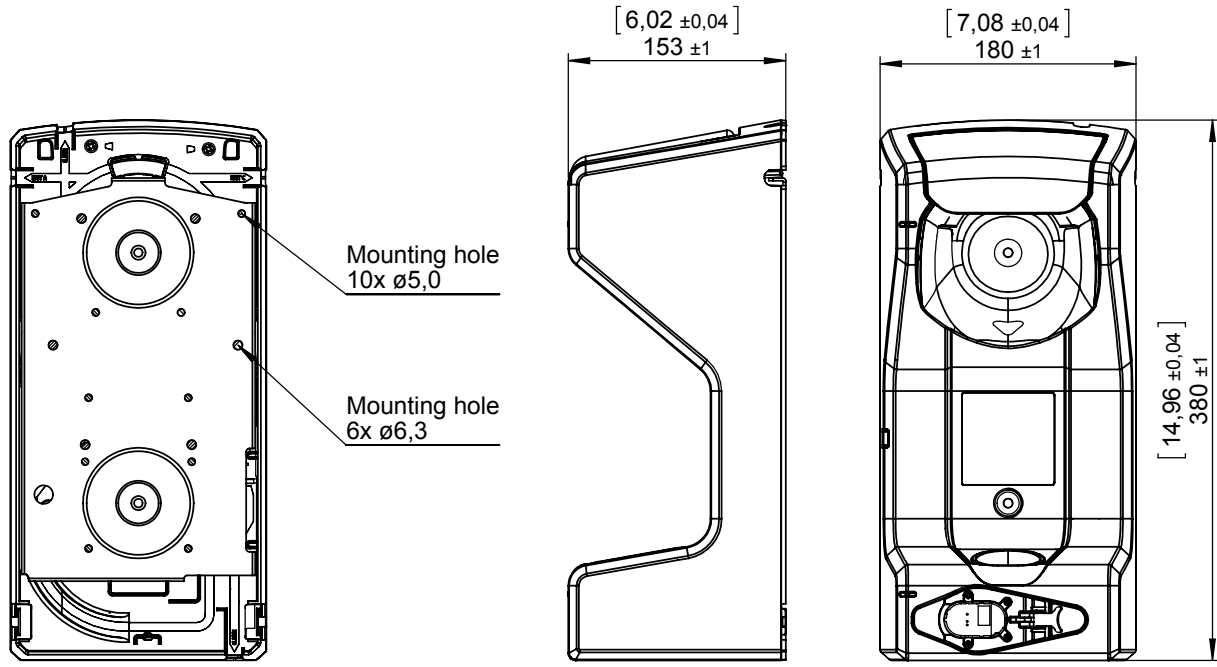

Konstr/Drawn P. MARCUS	Datum/Date 2013-04-08	Kontr/Check MABR	Material	
Ändrad av/Modified by P. MARCUS	Ändrad/Modified 2013-04-08	Ytjämnhet/Roughness Ra μ m	Ytbehandling/Surface treatment	
Där ej annat anges/Unless otherwise stated Gen tol ISO 2768-mK Utdrag ur/Excerpt from ISO 2768-m	Benämning/Denomination Basic dimensions In-truck charger			Skala/Scale 1:5
0.5-6 $\pm 0,1$ Hälkålsradier (6)-30 $\pm 0,2$ Fillet radii (30)-120 $\pm 0,3$ (120)-400 $\pm 0,5$ Kanter brutna (400)-1000 $\pm 0,8$ Edges broken				Blad/Sheet 1(1)
				Art.No. Size A4
				Ritn nr/Drawing No T127865
				Rev A

CE Declaration of Conformity

This is to certify that the System listed below have been designed and manufactured to meet the requirements, as applicable, of the following EU-Directives and corresponding harmonising standards. The systems consequently meet the requirements for the CE-mark.

Directives:

Directive 2004/108/EC; **Electromagnetic Compatibility**
Directive 2006/95/EC; **"Low voltage Directive" (Power Supply)**
Directive 2002/96/EC **Waste electrical and electronic equipment; WEEE**
 (As applicable)

Standards:

Emission: **EN 61000-6-3; Electromagnetic Compatibility**
 Generic standards - Emission

Immunity: **EN 61000-6-2; Electromagnetic Compatibility;**
 Generic standards - Immunity

Safety (Power Supply): **EN 60950; (or other) Safety of information technology**
 equipment

System: **FLIR KXX series**

FLIR Systems AB
Quality Assurance



Björn Svensson
Director

Cleaning, decontamination and disinfection

16.1 Cleaning

16.1.1 Camera housing, cables, and other items

16.1.1.1 Liquids

Use one of these liquids:

- Warm water
- A weak detergent solution

16.1.1.2 Equipment

A soft cloth

16.1.1.3 Procedure

Follow this procedure:

1. Soak the cloth in the liquid.
2. Twist the cloth to remove excess liquid.
3. Clean the part with the cloth.



CAUTION

Do not apply solvents or similar liquids to the camera, the cables, or other items. This can cause damage.

16.1.2 Infrared lens

16.1.2.1 Liquids

Use one of these liquids:

- A commercial lens cleaning liquid with more than 30% isopropyl alcohol.
- 96% ethyl alcohol (C₂H₅OH).

16.1.2.2 Equipment

Cotton wool

16.1.2.3 Procedure

Follow this procedure:

1. Soak the cotton wool in the liquid.
2. Twist the cotton wool to remove excess liquid.
3. Clean the lens one time only and discard the cotton wool.



WARNING

Make sure that you read all applicable MSDS (Material Safety Data Sheets) and warning labels on containers before you use a liquid: the liquids can be dangerous.



CAUTION

- Be careful when you clean the infrared lens. The lens has a delicate anti-reflective coating.
- Do not clean the infrared lens too vigorously. This can damage the anti-reflective coating.

16.2 Decontamination and disinfection

- The camera must be thoroughly cleaned, decontaminated and disinfected before shipping to our service department. No hazardous residues are allowed on cameras. Such residues include—but are not limited to—chemical fire-extinguishing compounds, radioactivity, biohazardous materials, and residues from chemical fires.
- FLIR Systems reserves the right to charge the full cost for the decontamination and disinfection of contaminated cameras that are shipped to our service department.

Maintenance, inspection, and service

The following maintenance and inspection procedures apply.

17.1 Maintenance

After each use:

1. Clean the camera according to section 16.1 *Cleaning*, page 70.
2. Charge the battery according to section 11.3 *Charging the battery*, page 23.

17.2 Inspection

After each use:

1. Verify the function and integrity of the latch that secures the battery.



CAUTION

Make sure that you do not use a torque value that is more than 80 Ncm on the Torx T20 screw. Damage to the camera can occur if you do not obey this.

2. Inspect the lens for scratches.
3. Inspect the screen for scratches.
4. Inspect the camera body for damage.
5. Verify the function of all buttons and triggers.
6. Inspect the attachment point for the lanyard strap/neck strap, and the attachment point for the retractable lanyard.

17.3 Service

For contact details to our service departments, use the following link:

<http://support.flir.com/service>

Storage conditions

The following storage conditions apply.

Storage temperature range	-40°C to +85°C (-40°F to +185°F)
Storage humidity	IEC 60068-2-30/24 h 95% relative humidity +25°C to +40°C (+77°F to +104°F) / 2 cycles

FLIR Systems was established in 1978 to pioneer the development of high-performance infrared imaging systems, and is the world leader in the design, manufacture, and marketing of thermal imaging systems for a wide variety of commercial, industrial, and government applications. Today, FLIR Systems embraces five major companies with outstanding achievements in infrared technology since 1958—the Swedish AGEMA Infrared Systems (formerly AGA Infrared Systems), the three United States companies Indigo Systems, FSI, and Inframetrics, and the French company Cedip.

Since 2007, FLIR Systems has acquired several companies with world-leading expertise in sensor technologies:

- Exttech Instruments (2007)
- Ifara Tecnologías (2008)
- Salvador Imaging (2009)
- OmniTech Partners (2009)
- Directed Perception (2009)
- Raymarine (2010)
- ICx Technologies (2010)
- TackTick Marine Digital Instruments (2011)
- Aerius Photonics (2011)
- Lorex Technology (2012)
- Traficon (2012)
- MARSS (2013)
- DigitalOptics micro-optics business (2013)

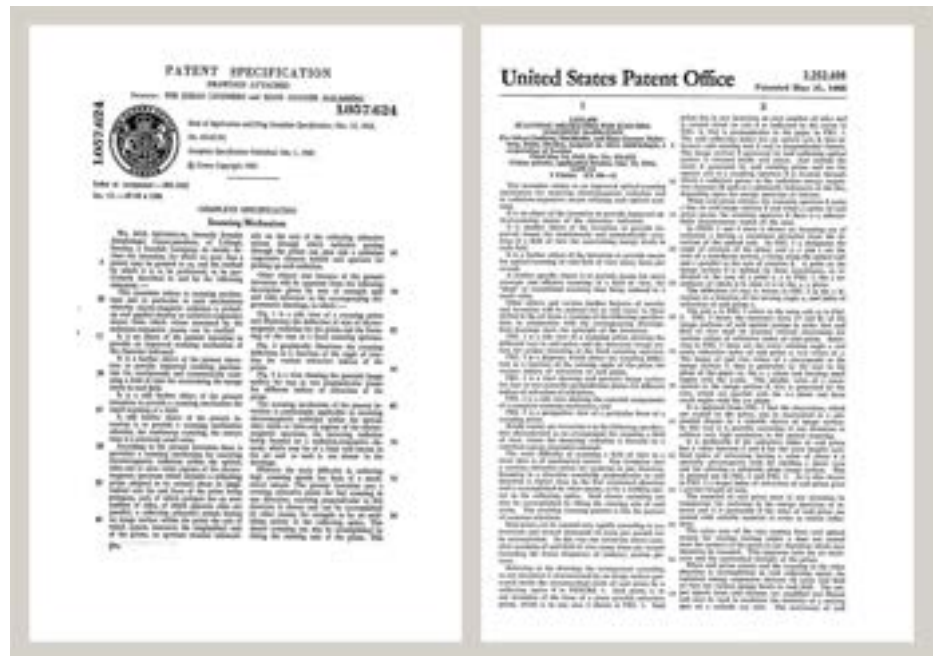

Figure 19.1 Patent documents from the early 1960s

The company has sold more than 350,000 infrared cameras worldwide for applications such as predictive maintenance, R & D, non-destructive testing, process control and automation, and machine vision, among many others.

FLIR Systems has three manufacturing plants in the United States (Portland, OR, Boston, MA, Santa Barbara, CA) and one in Sweden (Stockholm). Since 2007 there is also a

manufacturing plant in Tallinn, Estonia. Direct sales offices in Belgium, Brazil, China, France, Germany, Great Britain, Hong Kong, Italy, Japan, Korea, Sweden, and the USA— together with a worldwide network of agents and distributors—support our international customer base.

FLIR Systems is at the forefront of innovation in the infrared camera industry. We anticipate market demand by constantly improving our existing cameras and developing new ones. The company has set milestones in product design and development such as the introduction of the first battery-operated portable camera for industrial inspections, and the first uncooled infrared camera, to mention just two innovations.



Figure 19.2 1969: Thermovision Model 661. The camera weighed approximately 25 kg (55 lb.), the oscilloscope 20 kg (44 lb.), and the tripod 15 kg (33 lb.). The operator also needed a 220 VAC generator set, and a 10 L (2.6 US gallon) jar with liquid nitrogen. To the left of the oscilloscope the Polaroid attachment (6 kg/13 lb.) can be seen.



Figure 19.3 2015: FLIR One, an accessory to iPhone and Android mobile phones. Weight: 90 g (3.2 oz.).

FLIR Systems manufactures all vital mechanical and electronic components of the camera systems itself. From detector design and manufacturing, to lenses and system electronics, to final testing and calibration, all production steps are carried out and supervised by our own engineers. The in-depth expertise of these infrared specialists ensures the accuracy and reliability of all vital components that are assembled into your infrared camera.

19.1 More than just an infrared camera

At FLIR Systems we recognize that our job is to go beyond just producing the best infrared camera systems. We are committed to enabling all users of our infrared camera systems to work more productively by providing them with the most powerful camera–software combination. Especially tailored software for predictive maintenance, R & D, and process monitoring is developed in-house. Most software is available in a wide variety of languages.

We support all our infrared cameras with a wide variety of accessories to adapt your equipment to the most demanding infrared applications.

19.2 Sharing our knowledge

Although our cameras are designed to be very user-friendly, there is a lot more to thermography than just knowing how to handle a camera. Therefore, FLIR Systems has founded the Infrared Training Center (ITC), a separate business unit, that provides certified training

courses. Attending one of the ITC courses will give you a truly hands-on learning experience.

The staff of the ITC are also there to provide you with any application support you may need in putting infrared theory into practice.

19.3 Supporting our customers

FLIR Systems operates a worldwide service network to keep your camera running at all times. If you discover a problem with your camera, local service centers have all the equipment and expertise to solve it within the shortest possible time. Therefore, there is no need to send your camera to the other side of the world or to talk to someone who does not speak your language.

19.4 A few images from our facilities

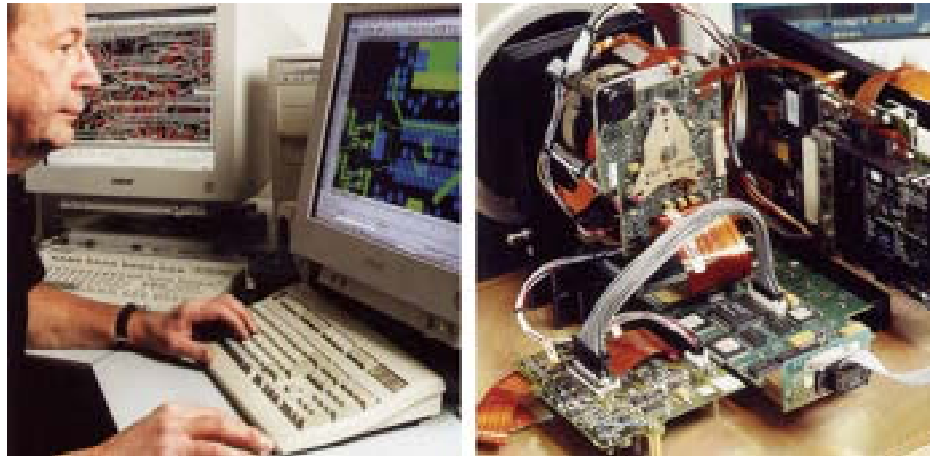

Figure 19.4 LEFT: Development of system electronics; RIGHT: Testing of an FPA detector



Figure 19.5 LEFT: Diamond turning machine; RIGHT: Lens polishing

Before the year 1800, the existence of the infrared portion of the electromagnetic spectrum wasn't even suspected. The original significance of the infrared spectrum, or simply 'the infrared' as it is often called, as a form of heat radiation is perhaps less obvious today than it was at the time of its discovery by Herschel in 1800.



Figure 20.1 Sir William Herschel (1738–1822)

The discovery was made accidentally during the search for a new optical material. Sir William Herschel – Royal Astronomer to King George III of England, and already famous for his discovery of the planet Uranus – was searching for an optical filter material to reduce the brightness of the sun's image in telescopes during solar observations. While testing different samples of colored glass which gave similar reductions in brightness he was intrigued to find that some of the samples passed very little of the sun's heat, while others passed so much heat that he risked eye damage after only a few seconds' observation.

Herschel was soon convinced of the necessity of setting up a systematic experiment, with the objective of finding a single material that would give the desired reduction in brightness as well as the maximum reduction in heat. He began the experiment by actually repeating Newton's prism experiment, but looking for the heating effect rather than the visual distribution of intensity in the spectrum. He first blackened the bulb of a sensitive mercury-in-glass thermometer with ink, and with this as his radiation detector he proceeded to test the heating effect of the various colors of the spectrum formed on the top of a table by passing sunlight through a glass prism. Other thermometers, placed outside the sun's rays, served as controls.

As the blackened thermometer was moved slowly along the colors of the spectrum, the temperature readings showed a steady increase from the violet end to the red end. This was not entirely unexpected, since the Italian researcher, Landriani, in a similar experiment in 1777 had observed much the same effect. It was Herschel, however, who was the first to recognize that there must be a point where the heating effect reaches a maximum, and that measurements confined to the visible portion of the spectrum failed to locate this point.



Figure 20.2 Marsilio Landriani (1746–1815)

Moving the thermometer into the dark region beyond the red end of the spectrum, Herschel confirmed that the heating continued to increase. The maximum point, when he found it, lay well beyond the red end – in what is known today as the ‘infrared wavelengths’.

When Herschel revealed his discovery, he referred to this new portion of the electromagnetic spectrum as the ‘thermometrical spectrum’. The radiation itself he sometimes referred to as ‘dark heat’, or simply ‘the invisible rays’. Ironically, and contrary to popular opinion, it wasn't Herschel who originated the term ‘infrared’. The word only began to appear in print around 75 years later, and it is still unclear who should receive credit as the originator.

Herschel's use of glass in the prism of his original experiment led to some early controversies with his contemporaries about the actual existence of the infrared wavelengths. Different investigators, in attempting to confirm his work, used various types of glass indiscriminately, having different transparencies in the infrared. Through his later experiments, Herschel was aware of the limited transparency of glass to the newly-discovered thermal radiation, and he was forced to conclude that optics for the infrared would probably be doomed to the use of reflective elements exclusively (i.e. plane and curved mirrors). Fortunately, this proved to be true only until 1830, when the Italian investigator, Melloni, made his great discovery that naturally occurring rock salt (NaCl) – which was available in large enough natural crystals to be made into lenses and prisms – is remarkably transparent to the infrared. The result was that rock salt became the principal infrared optical material, and remained so for the next hundred years, until the art of synthetic crystal growing was mastered in the 1930's.



Figure 20.3 Macedonio Melloni (1798–1854)

Thermometers, as radiation detectors, remained unchallenged until 1829, the year Nobili invented the thermocouple. (Herschel's own thermometer could be read to 0.2 °C (0.036 °F), and later models were able to be read to 0.05 °C (0.09 °F)). Then a breakthrough occurred; Melloni connected a number of thermocouples in series to form the first thermopile. The new device was at least 40 times as sensitive as the best thermometer of the day for detecting heat radiation – capable of detecting the heat from a person standing three meters away.

The first so-called ‘heat-picture’ became possible in 1840, the result of work by Sir John Herschel, son of the discoverer of the infrared and a famous astronomer in his own right. Based upon the differential evaporation of a thin film of oil when exposed to a heat pattern focused upon it, the thermal image could be seen by reflected light where the interference effects of the oil film made the image visible to the eye. Sir John also managed to obtain a primitive record of the thermal image on paper, which he called a ‘thermograph’.



Figure 20.4 Samuel P. Langley (1834–1906)

The improvement of infrared-detector sensitivity progressed slowly. Another major breakthrough, made by Langley in 1880, was the invention of the bolometer. This consisted of a thin blackened strip of platinum connected in one arm of a Wheatstone bridge circuit upon which the infrared radiation was focused and to which a sensitive galvanometer responded. This instrument is said to have been able to detect the heat from a cow at a distance of 400 meters.

An English scientist, Sir James Dewar, first introduced the use of liquefied gases as cooling agents (such as liquid nitrogen with a temperature of $-196\text{ }^{\circ}\text{C}$ ($-320.8\text{ }^{\circ}\text{F}$)) in low temperature research. In 1892 he invented a unique vacuum insulating container in which it is possible to store liquefied gases for entire days. The common ‘thermos bottle’, used for storing hot and cold drinks, is based upon his invention.

Between the years 1900 and 1920, the inventors of the world ‘discovered’ the infrared. Many patents were issued for devices to detect personnel, artillery, aircraft, ships – and even icebergs. The first operating systems, in the modern sense, began to be developed during the 1914–18 war, when both sides had research programs devoted to the military exploitation of the infrared. These programs included experimental systems for enemy intrusion/detection, remote temperature sensing, secure communications, and ‘flying torpedo’ guidance. An infrared search system tested during this period was able to detect an approaching airplane at a distance of 1.5 km (0.94 miles), or a person more than 300 meters (984 ft.) away.

The most sensitive systems up to this time were all based upon variations of the bolometer idea, but the period between the two wars saw the development of two revolutionary new infrared detectors: the image converter and the photon detector. At first, the image converter received the greatest attention by the military, because it enabled an observer for the first time in history to literally ‘see in the dark’. However, the sensitivity of the image converter was limited to the near infrared wavelengths, and the most interesting military targets (i.e. enemy soldiers) had to be illuminated by infrared search beams. Since this involved the risk of giving away the observer’s position to a similarly-equipped enemy observer, it is understandable that military interest in the image converter eventually faded.

The tactical military disadvantages of so-called ‘active’ (i.e. search beam-equipped) thermal imaging systems provided impetus following the 1939–45 war for extensive secret military infrared-research programs into the possibilities of developing ‘passive’ (no search beam) systems around the extremely sensitive photon detector. During this period, military secrecy regulations completely prevented disclosure of the status of infrared-imaging technology. This secrecy only began to be lifted in the middle of the 1950’s, and from that time adequate thermal-imaging devices finally began to be available to civilian science and industry.

A note on the technical production of this publication

This publication was produced using XML — the eXtensible Markup Language. For more information about XML, please visit <http://www.w3.org/XML/>

A note on the typeface used in this publication

This publication was typeset using Linotype Helvetica™ World. Helvetica™ was designed by Max Miedinger (1910–1980)

LOEF (List Of Effective Files)

T501016.xml; en-US; AO; 26515; 2015-06-08
T505471.xml; en-US; 9229; 2013-10-03
T505517.xml; en-US; 26061; 2015-05-28
T505846.xml; en-US; ; 25704; 2015-05-12
T505013.xml; en-US; 9229; 2013-10-03
T505691.xml; en-US; ; 25956; 2015-05-22
T505508.xml; en-US; 25967; 2015-05-22
T505509.xml; en-US; 26255; 2015-06-02
T505510.xml; en-US; 23457; 2015-02-25
T505511.xml; en-US; 26245; 2015-06-02
T505512.xml; en-US; 26252; 2015-06-02
T505514.xml; en-US; 26255; 2015-06-02
T505516.xml; en-US; 6342; 2013-01-25
T505790.xml; en-US; ; 25356; 2015-05-06
T505007.xml; en-US; 24845; 2015-04-20
T505005.xml; en-US; 12154; 2014-03-06



Corporate Headquarters

FLIR Systems, Inc.
27700 SW Parkway Ave.
Wilsonville, OR 97070
USA
Telephone: +1-503-498-3547

Website

<http://www.flir.com>

Customer support

<http://support.flir.com>

Copyright

© 2015, FLIR Systems, Inc. All rights reserved worldwide.

Disclaimer

Specifications subject to change without further notice. Models and accessories subject to regional market considerations. License procedures may apply. Products described herein may be subject to US Export Regulations. Please refer to exportquestions@flir.com with any questions.

Publ. No.: T559946
Release: AO
Commit: 26515
Head: 26515
Language: en-US
Modified: 2015-06-08
Formatted: 2015-06-08