

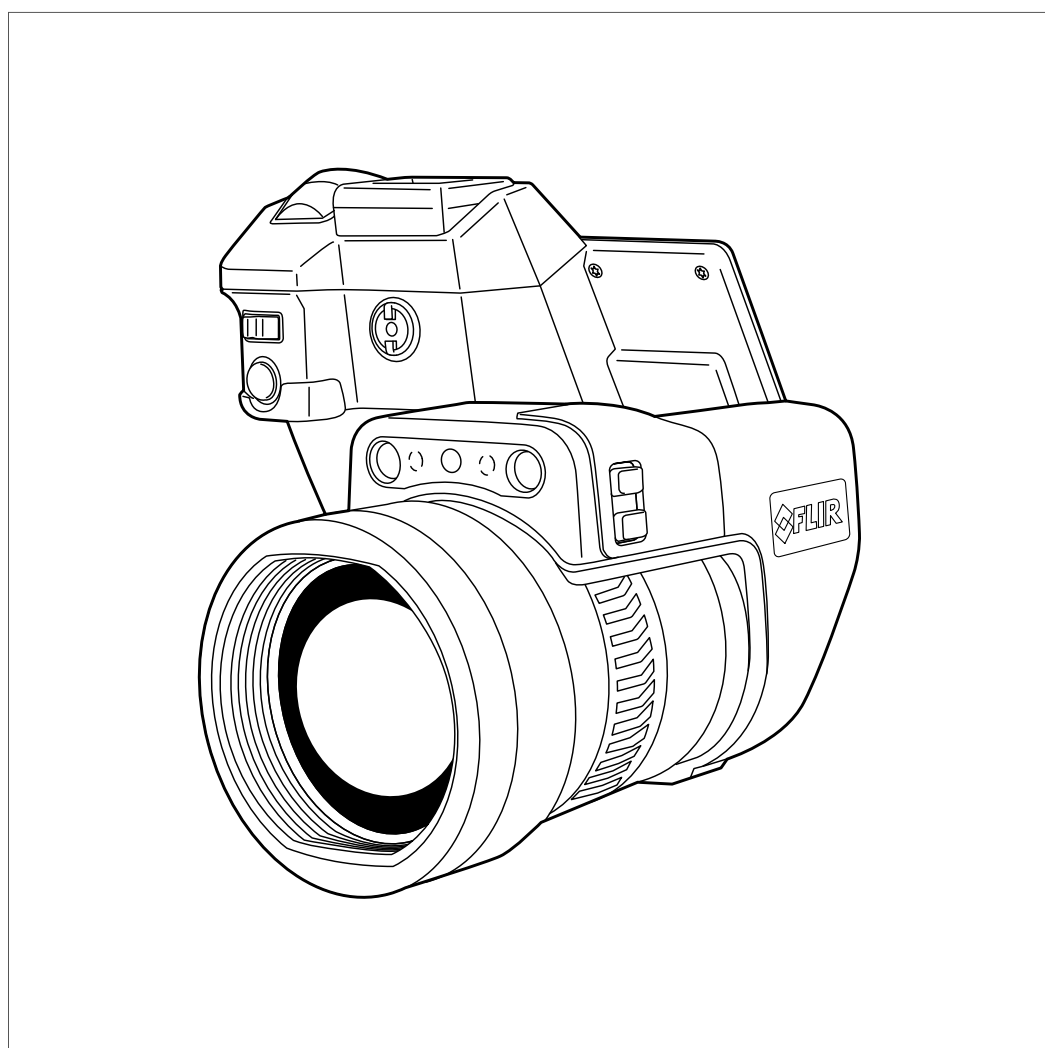

User's manual FLIR T10xx series



Important note

Before operating the device, you must read, understand, and follow all instructions, warnings, cautions, and legal disclaimers.

Důležitá poznámka

Před použitím zařízení si přečtěte veškeré pokyny, upozornění, varování a vyvázání se ze záruky, ujistěte se, že jim rozumíte, a řiďte se jimi.

Viktig meddelelse

Før du betjener enheden, skal du læse, forstå og følge alle anvisninger, advarsler, sikkerhedsforanstaltninger og ansvarsfraskrivelser.

Wichtiger Hinweis

Bevor Sie das Gerät in Betrieb nehmen, lesen, verstehen und befolgen Sie unbedingt alle Anweisungen, Warnungen, Vorsichtshinweise und Haftungsausschlüsse

Σημαντική σημείωση

Πριν από τη λειτουργία της συσκευής, πρέπει να διαβάσετε, να κατανοήσετε και να ακολουθήσετε όλες τις οδηγίες, προειδοποιήσεις, προφυλάξεις και νομικές αποποιήσεις.

Nota importante

Antes de usar el dispositivo, debe leer, comprender y seguir toda la información sobre instrucciones, advertencias, precauciones y renunciaciones de responsabilidad.

Tärkeä huomautus

Ennen laitteen käyttämistä on luettava ja ymmärrettävä kaikki ohjeet, vakavat varoitukset, varoitukset ja lakitiedotteet sekä noudatettava niitä.

Remarque importante

Avant d'utiliser l'appareil, vous devez lire, comprendre et suivre l'ensemble des instructions, avertissements, mises en garde et clauses légales de non-responsabilité.

Fontos megjegyzés

Az eszköz használatá elótt figyelmesen olvassa el és tartsa be az összes utasítást, figyelmeztetést, óvintézkedést és jogi nyilatkozatot.

Nota importante

Prima di utilizzare il dispositivo, è importante leggere, capire e seguire tutte le istruzioni, avvertenze, precauzioni ed esclusioni di responsabilità legali.

重要な注意

デバイスをご使用になる前に、あらゆる指示、警告、注意事項、および免責条項をお読み頂き、その内容を理解して従ってください。

중요한 참고 사항

장치를 작동하기 전에 반드시 다음의 사용 설명서와 경고, 주의사항, 법적 책임제한을 읽고 이해하며 따라야 합니다.

Viktig

Før du bruker enheten, må du lese, forstå og følge instruksjoner, advarsler og informasjon om ansvarsfraskrivelse.

Belangrijke opmerking

Zorg ervoor dat u, voordat u het apparaat gaat gebruiken, alle instructies, waarschuwingen en juridische informatie hebt doorgelezen en begrepen, en dat u deze opvolgt en in acht neemt.

Ważna uwaga

Przed rozpoczęciem korzystania z urządzenia należy koniecznie zapoznać się z wszystkimi instrukcjami, ostrzeżeniami, przestrożami i uwagami prawnymi. Należy zawsze postępować zgodnie z zaleceniami tam zawartymi.

Nota importante

Antes de utilizar o dispositivo, deverá proceder à leitura e compreensão de todos os avisos, precauções, instruções e isenções de responsabilidade legal e assegurar-se do seu cumprimento.

Важное примечание

До того, как пользоваться устройством, вам необходимо прочитать и понять все предупреждения, предостережения и юридические ограничения ответственности и следовать им.

Viktig information

Innan du använder enheten måste du läsa, förstå och följa alla anvisningar, varningar, försiktighetsåtgärder och ansvarsfriskrivningar.

Önemli not

Cihazı çalıştırmadan önce tüm talimatları, uyarıları, ikazları ve yasal açıklamaları okumalı, anlamalı ve bunlara uymalısınız.

重要注意事項

在操作设备之前，您必须阅读、理解并遵循所有说明、警告、注意事项和法律免责声明。

重要注意事項

操作裝置之前，您務必閱讀、了解並遵循所有說明、警告、注意事項與法律免責聲明。



User's manual FLIR T10xx series



Table of contents

1	Disclaimers	1
1.1	Legal disclaimer	1
1.2	Usage statistics	1
1.3	Changes to registry	1
1.4	U.S. Government Regulations.....	2
1.5	Copyright	2
1.6	Quality assurance	2
1.7	Patents.....	2
1.8	Third-party licenses.....	2
1.8.1	GNU Lesser General Public License (LGPL)	2
1.8.2	Fonts (Source Han Sans).....	2
1.8.3	Fonts (DejaVu)	3
2	Safety information	4
3	Notice to user	8
3.1	User-to-user forums	8
3.2	Calibration.....	8
3.3	Accuracy	8
3.4	Disposal of electronic waste	8
3.5	Training	8
3.6	Documentation updates	8
3.7	Important note about this manual.....	9
3.8	Note about authoritative versions.....	9
4	Customer help	10
4.1	General	10
4.2	Submitting a question	10
4.3	Downloads	10
5	Introduction	12
5.1	General description	12
5.2	Key benefits.....	12
6	Quick start guide	13
6.1	Procedure	13
6.2	To keep in mind	13
7	Register the camera	14
7.1	General	14
7.2	Procedure	14
8	About FLIR Tools/FLIR Tools+	19
8.1	Introduction	19
8.2	Workflow.....	20
8.2.1	General.....	20
8.2.2	Figure.....	20
8.2.3	Explanation.....	20
9	Using the high-speed interface (HSI)	21
9.1	General	21
9.2	System overview	21
9.2.1	Figure.....	21
9.2.2	Explanation.....	21
9.3	Quick start guide	22
9.4	HSI box indicator LED.....	22
9.5	Digital I/O.....	22
10	List of accessories and services	23
11	A note about ergonomics	24
11.1	General	24
11.2	Figure	24

Table of contents

12	Camera parts	25
12.1	View from the right	25
12.1.1	Figure	25
12.1.2	Explanation	25
12.2	View from the left	26
12.2.1	Figure	26
12.2.2	Explanation	26
12.3	View from the bottom	27
12.3.1	Figure	27
12.3.2	Explanation	27
12.4	View from the rear	28
12.4.1	Figure	28
12.4.2	Explanation	28
12.5	Neck strap attachment points	30
12.5.1	Figure	30
12.6	Battery condition LED indicator	30
12.6.1	Figure	30
12.6.2	Explanation	30
12.7	Power LED indicator	31
12.7.1	Figure	31
12.7.2	Explanation	31
12.8	Laser pointer	31
12.8.1	Figure	31
12.8.2	Laser warning label	32
12.8.3	Laser rules and regulations	32
13	Screen elements	33
13.1	General	33
13.2	Menu system	33
13.3	Status icons and indicators	34
13.4	Swipe-down menu	34
13.5	Image overlay information	34
14	Navigating the menu system	36
14.1	General	36
14.2	Navigating using the joystick	36
15	Handling the camera	37
15.1	Charging the battery	37
15.1.1	Using the power supply to charge the battery when it is inside the camera	37
15.1.2	Using the stand-alone battery charger to charge the battery	37
15.2	Turning on the camera	37
15.2.1	Procedure	37
15.3	Turning off the camera	38
15.3.1	Procedure	38
15.4	Adjusting the viewfinder's dioptic correction (sharpness)	38
15.4.1	Figure	38
15.4.2	Procedure	38
15.5	Adjusting the angle of the lens	39
15.5.1	Figure	39
15.6	Adjusting the infrared camera focus manually	39
15.6.1	Figure	39
15.6.2	Procedure	39
15.7	Autofocusing the infrared camera	40
15.7.1	General	40
15.7.2	Figure	40

Table of contents

15.7.3	Procedure	40
15.8	Continuous autofocus	40
15.8.1	General	40
15.8.2	Procedure	41
15.9	Operating the laser pointer	41
15.9.1	Figure	41
15.9.2	Procedure	41
15.10	Using the digital zoom function	42
15.10.1	General	42
15.10.2	Figure	42
15.10.3	Procedure	42
15.11	Assigning functions to the programmable buttons	42
15.11.1	General	42
15.11.2	Procedure	44
15.12	Using the camera lamp as a flash	44
15.12.1	General	44
15.12.2	Procedure	44
15.13	Moving files to a computer	45
15.13.1	General	45
15.13.2	Procedure	45
15.14	Changing lenses	46
15.15	Using the close-up lens	49
15.15.1	General	49
15.15.2	Attaching the close-up lens	49
15.15.3	Removing the close-up lens	51
15.16	Calibrating the compass	53
15.16.1	Procedure	53
16	Saving and working with images	54
16.1	About image files	54
16.1.1	General	54
16.1.2	File-naming convention	54
16.1.3	Storage capacity	54
16.1.4	About UltraMax	54
16.2	Saving an image	55
16.2.1	General	55
16.2.2	Procedure	55
16.3	Previewing an image	55
16.3.1	General	55
16.3.2	Procedure	55
16.4	Opening a saved image	55
16.4.1	General	55
16.4.2	Procedure	56
16.5	Editing a saved image	56
16.5.1	General	56
16.5.2	Procedure	56
16.5.3	Related topics	57
16.6	Displaying image information	57
16.6.1	General	57
16.6.2	Procedure	57
16.7	Creating a PDF report in the camera	57
16.7.1	General	57
16.7.2	Naming convention	57
16.7.3	Procedure	57
16.8	Zooming an image	58
16.8.1	General	58

Table of contents

16.8.2	Procedure	58
16.9	Deleting images	58
16.10	Resetting the image counter.....	58
16.10.1	General.....	58
16.10.2	Procedure	58
17	Working with the image archive.....	59
17.1	General	59
17.2	Opening image and video files.....	59
17.3	Creating a new folder.....	59
17.4	Renaming a folder.....	59
17.5	Changing the active folder	60
17.5.1	General.....	60
17.5.2	Procedure	60
17.6	Moving files between folders	60
17.7	Deleting a folder	60
17.8	Deleting an image or video file	61
17.8.1	General.....	61
17.8.2	Procedure	61
17.9	Deleting multiple files.....	61
17.9.1	General.....	61
17.9.2	Procedure	61
17.10	Deleting all files	62
17.10.1	General.....	62
17.10.2	Procedure	62
18	Achieving a good image	63
18.1	General	63
18.2	Adjusting the infrared camera focus	63
18.2.1	Manual focus.....	63
18.2.2	Autofocus	63
18.3	Adjusting the infrared image.....	63
18.3.1	General.....	63
18.3.2	Example 1	64
18.3.3	Example 2	64
18.3.4	Manual adjustment by touching the screen	65
18.3.5	Manual adjustment by using the joystick.....	66
18.3.6	Manual adjustment in <i>Level, Max, Min</i> mode	66
18.4	Changing the temperature range.....	67
18.4.1	General.....	67
18.4.2	Procedure	67
18.5	Changing the color palette	67
18.5.1	General.....	67
18.5.2	Procedure	68
18.6	Changing the measurement parameters	69
18.7	Performing a non-uniformity correction (NUC)	69
18.7.1	General.....	69
18.7.2	Performing an NUC manually.....	69
18.8	Hiding all overlay	69
18.8.1	General.....	69
18.8.2	Procedure	70
19	Working with image modes.....	71
19.1	General	71
19.2	Image examples	71
19.3	Selecting an image mode	72
20	Working with measurement tools	74
20.1	General	74

Table of contents

20.2	Adding/removing measurement tools	74
20.3	Editing user presets.....	74
20.3.1	General.....	74
20.3.2	Procedure	74
20.4	Moving and resizing a measurement tool	75
20.4.1	General.....	75
20.4.2	Moving a spot.....	75
20.4.3	Moving and resizing a box, circle, or line tool	76
20.5	Changing the measurement parameters	76
20.5.1	General.....	76
20.5.2	Types of parameters	76
20.5.3	Recommended values.....	77
20.5.4	Procedure	77
20.5.5	Related topics	78
20.6	Displaying values in the result table.....	78
20.6.1	General.....	78
20.6.2	Procedure	79
20.7	Displaying a graph	79
20.7.1	General.....	79
20.7.2	Procedure	79
20.8	Creating and setting up a difference calculation	80
20.8.1	General.....	80
20.8.2	Procedure	80
20.9	Setting a measurement alarm	80
20.9.1	General.....	80
20.9.2	Types of alarm	80
20.9.3	Alarm signals	81
20.9.4	Procedure	81
21	Working with color alarms and isotherms.....	83
21.1	Color alarms	83
21.1.1	General.....	83
21.1.2	Image examples	83
21.1.3	Setting up above, below, and interval alarms	84
21.1.4	Building isotherms.....	85
22	Annotating images	87
22.1	General	87
22.2	Adding a note	87
22.2.1	General.....	87
22.2.2	Procedure	87
22.3	Adding a text comment table	87
22.3.1	General.....	87
22.3.2	Procedure	88
22.3.3	Creating a text comment table template	88
22.4	Adding a voice annotation.....	90
22.4.1	General.....	90
22.4.2	Procedure	91
22.5	Adding a sketch.....	91
22.5.1	General.....	91
22.5.2	Procedure	91
23	Programming the camera (time-lapse)	93
23.1	General	93
23.2	Procedure	93
24	Recording video clips	94
24.1	General	94
24.2	Procedure	94

Table of contents

24.3	Playing a saved video clip.....	94
25	Screening alarm.....	95
25.1	General.....	95
25.2	Procedure.....	95
26	Pairing Bluetooth devices.....	97
26.1	General.....	97
26.2	Procedure.....	97
27	Configuring Wi-Fi.....	98
27.1	General.....	98
27.2	Setting up a wireless access point (most common use).....	98
27.3	Connecting the camera to a WLAN (less common use).....	98
28	Fetching data from external FLIR meters.....	99
28.1	General.....	99
28.2	Technical support for external meters.....	99
28.3	Procedure.....	99
28.4	Typical moisture measurement and documentation procedure.....	100
28.4.1	General.....	100
28.4.2	Procedure.....	100
28.5	More information.....	100
29	Changing settings.....	101
29.1	General.....	101
29.1.1	<i>Connections.....</i>	<i>101</i>
29.1.2	<i>Camera temperature range.....</i>	<i>101</i>
29.1.3	<i>Save options & storage.....</i>	<i>101</i>
29.1.4	<i>Device settings.....</i>	<i>102</i>
30	Technical data.....	105
30.1	Online field-of-view calculator.....	105
30.2	Note about technical data.....	105
30.3	Note about authoritative versions.....	105
30.4	FLIR T1010 12°.....	106
30.5	FLIR T1010 28°.....	111
30.6	FLIR T1010 45°.....	116
30.7	FLIR T1020 12°.....	121
30.8	FLIR T1020 28°.....	127
30.9	FLIR T1020 45°.....	133
30.10	FLIR T1020 28° and 12°.....	139
30.11	FLIR T1020 28° and 45°.....	145
30.12	FLIR T1020 28°, 12°, and 45°.....	151
30.13	FLIR T1030sc 12°.....	157
30.14	FLIR T1030sc 28°.....	164
30.15	FLIR T1030sc 45°.....	171
30.16	FLIR T1040 12°.....	178
30.17	FLIR T1040 28°.....	184
30.18	FLIR T1040 45°.....	190
30.19	FLIR T1050sc 12°.....	196
30.20	FLIR T1050sc 28°.....	203
30.21	FLIR T1050sc 45°.....	210
30.22	IR lens, f=36 mm (28°) with case.....	217
30.23	Close-up lens 3× (51 μm) with case.....	219
30.24	IR lens f=21.2 mm (45°) with case.....	220
30.25	IR lens f=83.4 mm (12°) with case.....	222
30.26	FLIR T10xx SC kit.....	224

Table of contents

31	Mechanical drawings	226
32	Digital I/O pin configuration	234
32.1	Pin configuration for the Digital I/O connector on the HSI box	234
33	Digital I/O connection diagram	235
34	CE Declaration of conformity	237
35	Cleaning the camera	239
35.1	Camera housing, cables, and other items	239
35.1.1	Liquids	239
35.1.2	Equipment	239
35.1.3	Procedure	239
35.2	Infrared lens	239
35.2.1	Liquids	239
35.2.2	Equipment	239
35.2.3	Procedure	239
35.3	Infrared detector	240
35.3.1	General	240
35.3.2	Procedure	240
36	Application examples	241
36.1	Moisture & water damage	241
36.1.1	General	241
36.1.2	Figure	241
36.2	Faulty contact in socket	241
36.2.1	General	241
36.2.2	Figure	241
36.3	Oxidized socket	242
36.3.1	General	242
36.3.2	Figure	242
36.4	Insulation deficiencies	243
36.4.1	General	243
36.4.2	Figure	243
36.5	Draft	243
36.5.1	General	243
36.5.2	Figure	243
37	About FLIR Systems	245
37.1	More than just an infrared camera	246
37.2	Sharing our knowledge	246
37.3	Supporting our customers	247
38	Terms, laws, and definitions	248
39	Thermographic measurement techniques	250
39.1	Introduction	250
39.2	Emissivity	250
39.2.1	Finding the emissivity of a sample	250
39.3	Reflected apparent temperature	254
39.4	Distance	254
39.5	Relative humidity	254
39.6	Other parameters	254
40	About calibration	255
40.1	Introduction	255
40.2	Definition—what is calibration?	255
40.3	Camera calibration at FLIR Systems	255
40.4	The differences between a calibration performed by a user and that performed directly at FLIR Systems	256
40.5	Calibration, verification and adjustment	256

Table of contents

40.6	Non-uniformity correction.....	257
40.7	Thermal image adjustment (thermal tuning)	257
41	History of infrared technology.....	258
42	Theory of thermography.....	261
42.1	Introduction	261
42.2	The electromagnetic spectrum.....	261
42.3	Blackbody radiation.....	261
42.3.1	Planck's law	262
42.3.2	Wien's displacement law.....	263
42.3.3	Stefan-Boltzmann's law	264
42.3.4	Non-blackbody emitters.....	265
42.4	Infrared semi-transparent materials.....	267
43	The measurement formula.....	268
44	Emissivity tables	272
44.1	References.....	272
44.2	Tables	272

1.1 Legal disclaimer

All products manufactured by FLIR Systems are warranted against defective materials and workmanship for a period of one (1) year from the delivery date of the original purchase, provided such products have been under normal storage, use and service, and in accordance with FLIR Systems instruction.

Uncooled handheld infrared cameras manufactured by FLIR Systems are warranted against defective materials and workmanship for a period of two (2) years from the delivery date of the original purchase, provided such products have been under normal storage, use and service, and in accordance with FLIR Systems instruction, and provided that the camera has been registered within 60 days of original purchase.

Detectors for uncooled handheld infrared cameras manufactured by FLIR Systems are warranted against defective materials and workmanship for a period of ten (10) years from the delivery date of the original purchase, provided such products have been under normal storage, use and service, and in accordance with FLIR Systems instruction, and provided that the camera has been registered within 60 days of original purchase.

Products which are not manufactured by FLIR Systems but included in systems delivered by FLIR Systems to the original purchaser, carry the warranty, if any, of the particular supplier only. FLIR Systems has no responsibility whatsoever for such products.

The warranty extends only to the original purchaser and is not transferable. It is not applicable to any product which has been subjected to misuse, neglect, accident or abnormal conditions of operation. Expendable parts are excluded from the warranty.

In the case of a defect in a product covered by this warranty the product must not be further used in order to prevent additional damage. The purchaser shall promptly report any defect to FLIR Systems or this warranty will not apply.

FLIR Systems will, at its option, repair or replace any such defective product free of charge if, upon inspection, it proves to be defective in material or workmanship and provided that it is returned to FLIR Systems within the said one-year period.

FLIR Systems has no other obligation or liability for defects than those set forth above.

No other warranty is expressed or implied. FLIR Systems specifically disclaims the implied warranties of merchantability and fitness for a particular purpose.

FLIR Systems shall not be liable for any direct, indirect, special, incidental or consequential loss or damage, whether based on contract, tort or any other legal theory.

This warranty shall be governed by Swedish law.

Any dispute, controversy or claim arising out of or in connection with this warranty, shall be finally settled by arbitration in accordance with the Rules of the Arbitration Institute of the Stockholm Chamber of Commerce. The place of arbitration shall be Stockholm. The language to be used in the arbitral proceedings shall be English.

1.2 Usage statistics

FLIR Systems reserves the right to gather anonymous usage statistics to help maintain and improve the quality of our software and services.

1.3 Changes to registry

The registry entry HKEY_LOCAL_MACHINE\SYSTEM\CurrentControlSet\Control\Lsa\LmCompatibilityLevel will be automatically changed to level 2 if the FLIR Camera Monitor service detects a FLIR camera connected to the computer with a USB cable. The modification will only be executed if the camera device implements a remote network service that supports network logons.

1.4 U.S. Government Regulations

This product may be subject to U.S. Export Regulations. Please send any inquiries to exportquestions@flir.com.

1.5 Copyright

© 2016, FLIR Systems, Inc. All rights reserved worldwide. No parts of the software including source code may be reproduced, transmitted, transcribed or translated into any language or computer language in any form or by any means, electronic, magnetic, optical, manual or otherwise, without the prior written permission of FLIR Systems.

The documentation must not, in whole or part, be copied, photocopied, reproduced, translated or transmitted to any electronic medium or machine readable form without prior consent, in writing, from FLIR Systems.

Names and marks appearing on the products herein are either registered trademarks or trademarks of FLIR Systems and/or its subsidiaries. All other trademarks, trade names or company names referenced herein are used for identification only and are the property of their respective owners.

1.6 Quality assurance

The Quality Management System under which these products are developed and manufactured has been certified in accordance with the ISO 9001 standard.

FLIR Systems is committed to a policy of continuous development; therefore we reserve the right to make changes and improvements on any of the products without prior notice.

1.7 Patents

000439161; 000653423; 000726344; 000859020; 001707738; 001707746; 001707787; 001776519; 001954074; 002021543; 002021543-0002; 002058180; 002249953; 002531178; 002816785; 002816793; 011200326; 014347553; 057692; 061609; 07002405; 100414275; 101796816; 101796817; 101796818; 102334141; 1062100; 11063060001; 11517895; 1226865; 12300216; 12300224; 1285345; 1299699; 1325808; 1336775; 1391114; 1402918; 1404291; 1411581; 1415075; 1421497; 1458284; 1678485; 1732314; 17399650; 1880950; 1886650; 2007301511414; 2007303395047; 2008301285812; 2009301900619; 20100060357; 2010301761271; 2010301761303; 2010301761572; 2010305959313; 2011304423549; 2012304717443; 2012306207318; 2013302676195; 2015202354035; 2015304259171; 204465713; 204967995; 2106017; 2107799; 2115696; 2172004; 2315433; 2381417; 2794760001; 3006596; 3006597; 303330211; 4358936; 483782; 484155; 4889913; 4937897; 4995790001; 5177595; 540838; 579475; 584755; 599392; 60122153; 6020040116815; 602006006500.0; 6020080347796; 6020110003453; 6151113; 6151116; 664580; 664581; 665004; 665440; 67023029; 6707044; 677298; 68657; 69036179; 70022216; 70028915; 70028923; 70057990; 7034300; 710424; 7110035; 7154093; 7157705; 718801; 723605; 7237946; 7312822; 7332716; 7336823; 734803; 7544944; 7606484; 7634157; 7667198; 7809258; 7826736; 8018649; 8153971; 8212210; 8289372; 8340414; 8354639; 8384783; 8520970; 8565547; 8595689; 8599262; 8654239; 8680468; 8803093; 8823803; 8853631; 8933403; 9171361; 9191583; 9279728; 9280812; 9338352; 9423940; 9471970; 9595087; D549758.

1.8 Third-party licenses

1.8.1 GNU Lesser General Public License (LGPL)

<http://www.gnu.org/licenses/lgpl-2.1.en.html>

(Retrieved May 27, 2015)

1.8.2 Fonts (Source Han Sans)









<https://github.com/adobe-fonts/source-han-sans/blob/master/LICENSE.txt>











(Retrieved May 27, 2015)











1.8.3 Fonts (*DejaVu*)









<http://dejavu-fonts.org/wiki/License>

(Retrieved May 27, 2015)

 WARNING
<p>Applicability: Class B digital devices.</p> <p>This equipment has been tested and found to comply with the limits for a Class B digital device, pursuant to Part 15 of the FCC Rules. These limits are designed to provide reasonable protection against harmful interference in a residential installation. This equipment generates, uses and can radiate radio frequency energy and, if not installed and used in accordance with the instructions, may cause harmful interference to radio communications. However, there is no guarantee that interference will not occur in a particular installation. If this equipment does cause harmful interference to radio or television reception, which can be determined by turning the equipment off and on, the user is encouraged to try to correct the interference by one or more of the following measures:</p> <ul style="list-style-type: none"> • Reorient or relocate the receiving antenna. • Increase the separation between the equipment and receiver. • Connect the equipment into an outlet on a circuit different from that to which the receiver is connected. • Consult the dealer or an experienced radio/TV technician for help.
 WARNING
<p>Applicability: Digital devices subject to 15.19/RSS-247 issue 1.</p> <p>NOTICE: This device complies with Part 15 of the FCC Rules and with RSS-247 issue 1 of Industry Canada. Operation is subject to the following two conditions:</p> <ol style="list-style-type: none"> 1. this device may not cause harmful interference, and 2. this device must accept any interference received, including interference that may cause undesired operation.
 WARNING
<p>This device is granted pursuant to the Japanese Radio Law (電波法) and the Japanese Telecommunications Business Law (電気通信事業法). This device should not be modified (otherwise the granted designation number will become invalid)</p>
 WARNING
<p>Applicability: Digital devices subject to 15.21.</p> <p>NOTICE: Changes or modifications made to this equipment not expressly approved by FLIR Systems may void the FCC authorization to operate this equipment.</p>
 WARNING
<p>Applicability: Digital devices subject to 2.1091/2.1093/OET Bulletin 65.</p> <p>Radiofrequency radiation exposure Information: The radiated output power of the device is below the FCC/IC radio frequency exposure limits. Nevertheless, the device shall be used in such a manner that the potential for human contact during normal operation is minimized.</p>
 WARNING
<p>Applicability: Cameras with one or more laser pointers.</p> <p>Do not look directly into the laser beam. The laser beam can cause eye irritation.</p>
 WARNING
<p>Applicability: Cameras with one or more batteries.</p> <p>Do not disassemble or do a modification to the battery. The battery contains safety and protection devices which, if damage occurs, can cause the battery to become hot, or cause an explosion or an ignition.</p>
 WARNING
<p>Applicability: Cameras with one or more batteries.</p> <p>If there is a leak from the battery and you get the fluid in your eyes, do not rub your eyes. Flush well with water and immediately get medical care. The battery fluid can cause injury to your eyes if you do not do this.</p>

 WARNING
Applicability: Cameras with one or more batteries. Do not continue to charge the battery if it does not become charged in the specified charging time. If you continue to charge the battery, it can become hot and cause an explosion or ignition. Injury to persons can occur.
 WARNING
Applicability: Cameras with one or more batteries. Only use the correct equipment to remove the electrical power from the battery. If you do not use the correct equipment, you can decrease the performance or the life cycle of the battery. If you do not use the correct equipment, an incorrect flow of current to the battery can occur. This can cause the battery to become hot, or cause an explosion. Injury to persons can occur.
 CAUTION
Only use the camera with a battery that has the item part number T199364 on it (that FLIR Systems supplies).
 WARNING
Make sure that you read all applicable MSDS (Material Safety Data Sheets) and warning labels on containers before you use a liquid. The liquids can be dangerous. Injury to persons can occur.
 CAUTION
Do not point the infrared camera (with or without the lens cover) at strong energy sources, for example, devices that cause laser radiation, or the sun. This can have an unwanted effect on the accuracy of the camera. It can also cause damage to the detector in the camera.
 CAUTION
Do not use the camera in temperatures more than +50°C (+122°F), unless other information is specified in the user documentation or technical data. High temperatures can cause damage to the camera.
 CAUTION
Applicability: Cameras with one or more laser pointers. To prevent damage, put the protective cap on the laser pointer when you do not operate the laser pointer. Damage to the laser pointer can occur if you do not do this.
 CAUTION
Applicability: Cameras with one or more batteries. Do not attach the batteries directly to a car's cigarette lighter socket, unless FLIR Systems supplies a specific adapter to connect the batteries to a cigarette lighter socket. Damage to the batteries can occur.
 CAUTION
Applicability: Cameras with one or more batteries. Do not connect the positive terminal and the negative terminal of the battery to each other with a metal object (such as wire). Damage to the batteries can occur.
 CAUTION
Applicability: Cameras with one or more batteries. Do not get water or salt water on the battery, or permit the battery to become wet. Damage to the batteries can occur.

 CAUTION
Applicability: Cameras with one or more batteries. Do not make holes in the battery with objects. Damage to the battery can occur.
 CAUTION
Applicability: Cameras with one or more batteries. Do not hit the battery with a hammer. Damage to the battery can occur.
 CAUTION
Applicability: Cameras with one or more batteries. Do not put your foot on the battery, hit it or cause shocks to it. Damage to the battery can occur.
 CAUTION
Applicability: Cameras with one or more batteries. Do not put the batteries in or near a fire, or into direct sunlight. When the battery becomes hot, the built-in safety equipment becomes energized and can stop the battery charging procedure. If the battery becomes hot, damage can occur to the safety equipment and this can cause more heat, damage or ignition of the battery.
 CAUTION
Applicability: Cameras with one or more batteries. Do not put the battery on a fire or increase the temperature of the battery with heat. Damage to the battery and injury to persons can occur.
 CAUTION
Applicability: Cameras with one or more batteries. Do not put the battery on or near fires, stoves, or other high-temperature locations. Damage to the battery and injury to persons can occur.
 CAUTION
Applicability: Cameras with one or more batteries. Do not solder directly onto the battery. Damage to the battery can occur.
 CAUTION
Applicability: Cameras with one or more batteries. Do not use the battery if, when you use, charge, or put the battery in storage, there is an unusual smell from the battery, the battery feels hot, changes color, changes shape, or is in an unusual condition. Speak with your sales office if one or more of these problems occurs. Damage to the battery and injury to persons can occur.
 CAUTION
Applicability: Cameras with one or more batteries. Only use a specified battery charger when you charge the battery. Damage to the battery can occur if you do not do this.
 CAUTION
Applicability: Cameras with one or more batteries. Only use a specified battery for the camera. Damage to the camera and the battery can occur if you do not do this.

 CAUTION
Applicability: Cameras with one or more batteries. The temperature range through which you can charge the battery is 0°C to +45°C (+32°F to +113°F), except for the Korean market: +10°C to +45°C (+50°F to +113°F). If you charge the battery at temperatures out of this range, it can cause the battery to become hot or to break. It can also decrease the performance or the life cycle of the battery.
 CAUTION
Applicability: Cameras with one or more batteries. The temperature range through which you can charge the battery is 0°C to +45°C (+32°F to +113°F). If you charge the battery at temperatures out of this range, it can cause the battery to become hot or to break. It can also decrease the performance or the life cycle of the battery.
 CAUTION
Applicability: Cameras with one or more batteries. The temperature range through which you can remove the electrical power from the battery is -15°C to +50°C (+5°F to +122°F), unless other information is specified in the user documentation or technical data. If you operate the battery out of this temperature range, it can decrease the performance or the life cycle of the battery.
 CAUTION
Applicability: Cameras with one or more batteries. When the battery is worn, apply insulation to the terminals with adhesive tape or equivalent materials before you discard it. Damage to the battery and injury to persons can occur if you do not do this.
 CAUTION
Applicability: Cameras with one or more batteries. Remove any water or moisture on the battery before you install it. Damage to the battery can occur if you do not do this.
 CAUTION
Do not apply solvents or equivalent liquids to the camera, the cables, or other items. Damage to the battery and injury to persons can occur.
 CAUTION
Be careful when you clean the infrared lens. The lens has an anti-reflective coating which is easily damaged. Damage to the infrared lens can occur.
 CAUTION
Do not use too much force to clean the infrared lens. This can cause damage to the anti-reflective coating.
Note The encapsulation rating is only applicable when all the openings on the camera are sealed with their correct covers, hatches, or caps. This includes the compartments for data storage, batteries, and connectors.
 CAUTION
Applicability: Cameras with a viewfinder. Make sure that the beams from the intensive energy sources do not go into the viewfinder. The beams can cause damage to the camera. This includes the devices that emit laser radiation, or the sun.

3.1 User-to-user forums

Exchange ideas, problems, and infrared solutions with fellow thermographers around the world in our user-to-user forums. To go to the forums, visit:

<http://forum.infraredtraining.com/>

3.2 Calibration

We recommend that you send in the camera for calibration once a year. Contact your local sales office for instructions on where to send the camera.

3.3 Accuracy

For very accurate results, we recommend that you wait 5 minutes after you have started the camera before measuring a temperature.

3.4 Disposal of electronic waste

Electrical and electronic equipment (EEE) contains materials, components and substances that may be hazardous and present a risk to human health and the environment when waste electrical and electronic equipment (WEEE) is not handled correctly.

Equipment marked with the below crossed-out wheeled bin is electrical and electronic equipment. The crossed-out wheeled bin symbol indicates that waste electrical and electronic equipment should not be discarded together with unseparated household waste, but must be collected separately.

For this purpose all local authorities have established collection schemes under which residents can dispose waste electrical and electronic equipment at a recycling centre or other collection points, or WEEE will be collected directly from households. More detailed information is available from the technical administration of the relevant local authority.



3.5 Training

To read about infrared training, visit:

- <http://www.infraredtraining.com>
- <http://www.irtraining.com>
- <http://www.irtraining.eu>

3.6 Documentation updates

Our manuals are updated several times per year, and we also issue product-critical notifications of changes on a regular basis.

To access the latest manuals, translations of manuals, and notifications, go to the Download tab at:

<http://support.flir.com>

It only takes a few minutes to register online. In the download area you will also find the latest releases of manuals for our other products, as well as manuals for our historical and obsolete products.

3.7 Important note about this manual

FLIR Systems issues generic manuals that cover several cameras within a model line.

This means that this manual may contain descriptions and explanations that do not apply to your particular camera model.

3.8 Note about authoritative versions

The authoritative version of this publication is English. In the event of divergences due to translation errors, the English text has precedence.

Any late changes are first implemented in English.



4.1 General

For customer help, visit:

<http://support.flir.com>

4.2 Submitting a question

To submit a question to the customer help team, you must be a registered user. It only takes a few minutes to register online. If you only want to search the knowledgebase for existing questions and answers, you do not need to be a registered user.

When you want to submit a question, make sure that you have the following information to hand:

- The camera model
- The camera serial number
- The communication protocol, or method, between the camera and your device (for example, SD card reader, HDMI, Ethernet, USB, or FireWire)
- Device type (PC/Mac/iPhone/iPad/Android device, etc.)
- Version of any programs from FLIR Systems
- Full name, publication number, and revision number of the manual

4.3 Downloads

On the customer help site you can also download the following, when applicable for the product:

- Firmware updates for your infrared camera.
- Program updates for your PC/Mac software.
- Freeware and evaluation versions of PC/Mac software.
- User documentation for current, obsolete, and historical products.
- Mechanical drawings (in *.dxf and *.pdf format).
- Cad data models (in *.stp format).
- Application stories.
- Technical datasheets.
- Product catalogs.



5.1 General description

The FLIR T10xx series is designed for the expert requiring the highest performance and the latest technology available. The camera series combines excellent ergonomics and feature-rich flexibility with superior image quality of 1024 × 768 pixel infrared resolution. High accuracy and sensitivity together with radiometric recording and streaming options make the FLIR T10xx series well suited for advanced research and development.

5.2 Key benefits

- Tailor made for research and development: The FLIR T10xx series has high accuracy and high sensitivity, to accurately measure the smallest temperature differences. With real-time radiometric recording by the camera, it is possible to capture fast events on the camera's SD card for further analysis by the supplied analysis software.
- Flexible and feature rich: A wide variety of measuring and analysis functions makes the camera flexible for your every need. Two programmable buttons provide easy access to favorite functions.
- Highest performance with the latest technology: The FLIR T10xx series is equipped with the innovative Multi Spectral Dynamic Imaging (MSX) feature, which produces an image richer in detail than ever before. With its continuous autofocus, the FLIR T10xx series is a fully automatic infrared camera.

6.1 Procedure

Follow this procedure:

1. Put a battery into the battery compartment.
2. Charge the battery for 4 hours before starting the camera for the first time.
3. Insert a memory card into the card slot.

Note Empty or use a memory card that has not previously been used in another version or type of camera. The cameras may organize files differently on the memory card. There is therefore a risk of losing data if the same memory card is used in different versions or types of cameras.

4. Push the On/off button  to turn on the camera.
5. Aim the camera toward the object of interest.
6. Adjust the infrared camera focus.

Note It is very important to adjust the focus correctly. Incorrect focus adjustment affects how the image modes work. It also affects the temperature measurement.

7. Push the Save button fully down to save an image.
8. Download and install FLIR Tools/Tools+ or FLIR Report Studio on your computer.¹
9. Start FLIR Tools/Tools+ or FLIR Report Studio.
10. Connect the camera to the computer using the USB cable.
11. Import the images into FLIR Tools/Tools+ or FLIR Report Studio and create an inspection report.
12. Send the inspection report to your client.

6.2 To keep in mind

- Adjust the focus first. When the camera is out of focus, the measurement will be wrong.
- By default, most cameras adapt the scale automatically. Use this mode first, but do not hesitate to set the scale manually.
- A thermal camera has a resolution limit. This depends on the size of the detector, the lens, and the distance to the target. Use the center of the spot tool as a guide to the minimum possible object size, and get closer if necessary. Make sure to stay away from dangerous areas and live electrical components.
- Be careful when holding the camera perpendicular to the target. Be observant of reflections, especially at low emissivities—you, the camera, or the surroundings may become the main source of reflection.
- Select a zone of high emissivity, e.g., an area with a matte surface, to perform a measurement.
- Blank objects, i.e., those with low emissivities, may appear warm or cold in the camera, because they mainly reflect the environment.
- Avoid direct sunlight on the details that you are inspecting.
- Various types of faults, e.g., those in a building's construction, may result in the same type of thermal pattern.
- Correctly analyzing an infrared image requires professional knowledge about the application.

1. FLIR Tools+ and FLIR Report Studio are licensed software.

Register the camera

7.1 General

Register your camera to receive an extended warranty and other related benefits.

To register the camera, you must log in using a FLIR Customer Support account. If you already have an existing FLIR Customer Support account, you can use the same login credentials. To complete the registration, you must enter a four-digit verification code into the camera.

7.2 Procedure

Follow this procedure:

1. Use a computer or other device with internet access and go to the following website:

<http://support.flir.com/camreg>

This displays the following dialog:

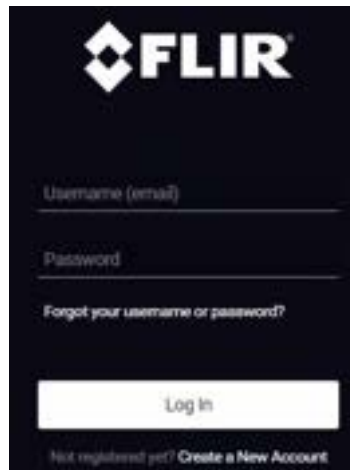

2. To log in with your existing FLIR Customer Support account, do the following:
 - 2.1. Enter your *Username* and *Password*.
 - 2.2. Click *Log In*.

3. To create a new FLIR Customer Support account, do the following:

- 3.1. Click *Create a New Account*.
- 3.2. Enter the required information and click *Create Account*.

The screenshot shows the 'FLIR Customer Support Center' website with a 'Create Account' form. The form is divided into two main sections: 'New Account' and 'Contact Information'. The 'New Account' section includes fields for 'Username (email)', 'Password', and 'Verify Password', with a note that the password must be at least 8 characters. The 'Contact Information' section includes fields for 'First Name', 'Last Name', 'Email Address', 'Telephone', 'Company', 'Address', 'City', 'State', 'Postal Code', and 'Country'. A 'Create Account' button is located at the bottom of the form.

4. On the camera, select  (*Settings*) > *Device settings* > *Camera information* > *Register camera*. This displays the following dialog box:

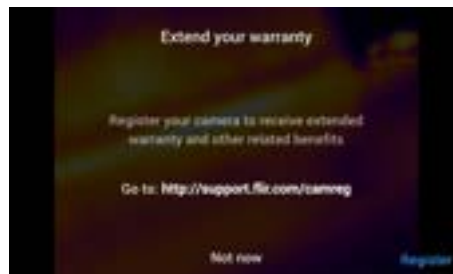

Note The first time you start the camera, the registration dialog box is displayed as a part of the setup of regional settings.

Register the camera

5. Select *Register* and push the joystick. This displays a dialog box with the serial number of the camera.

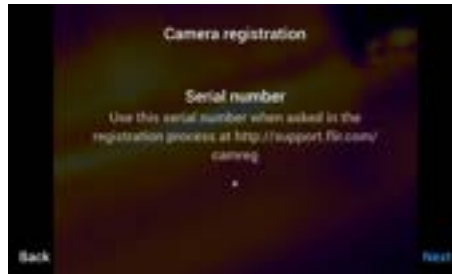

6. On the computer, enter the serial number of the camera and click *Validate*.

FLIR Customer Support Center

Home Answers Ask a Question Product Registration Downloads My Stuff Service

FLIR Product Registration

Please see this [FAQ](#) answer for information on registration of FLIR Security products.

Serial number

Enter your serial number in the textbox and click Validate

Validate

7. When the serial number is validated, click *Continue*.

FLIR Customer Support Center

Home Answers Ask a Question Product Registration Downloads My Stuff Service

FLIR Product Registration

Please see this [FAQ](#) answer for information on registration of FLIR Security products.

Serial number

Enter your serial number in the textbox and click Validate

Validate

Part number	Description
72202-0303	FLIR

Your serial number is validated and was found, please click Continue.

Continue

8. Enter the required information and click *Register Product*.

FLIR Customer Support Center

Home Answers Ask a Question Product Registration Downloads My Stuff Service

FLIR Product Registration

*** Required Information**

First name *	<input type="text"/>	Company *	<input type="text"/>
Last name *	<input type="text"/>	Address *	<input type="text"/>
Title	<input type="text"/>	City *	<input type="text"/>
Email *	<input type="text"/>	State/Province	<input type="text"/>
Telephone *	<input type="text"/>	Postal Code *	<input type="text"/>
Country *	<input type="text"/>		

Choose Industry 
The core business of your company *

Choose Application 
The main application for your FLIR product *

Click the button to register
FLIR
Serial number 72204950

9. When the registration is completed, the four-digit code is displayed.

FLIR Customer Support Center

Home Answers Ask a Question Product Registration Downloads My Stuff Service

FLIR Product Registration

Thank you for registering your product.

Use the code below to unlock your camera:
XXXX-XXXX

Your warranty has been extended to two (2) years.
Your product will be visible under My Stuff - Products

Note

- The code is also sent by e-mail to the address registered with your FLIR Customer Support account.
- The code is also displayed in your FLIR Customer Support portal under *My Stuff > Products*.

10. On the camera, do the following to enter the code:

- Move the joystick up/down to select a digit.
- Move the joystick left/right to navigate to the previous/next digit.
- When all digits have been entered, move the joystick right to select *Submit*. Push the joystick to confirm.



11. The camera is now registered and your extended warranty is activated.

8.1 Introduction

FLIR Tools is available as a free download at <http://support.flir.com/tools>. FLIR Tools+ provides extended functionality to the standard FLIR Tools software. A license card for FLIR Tools+ is included with the FLIR T10xx camera.

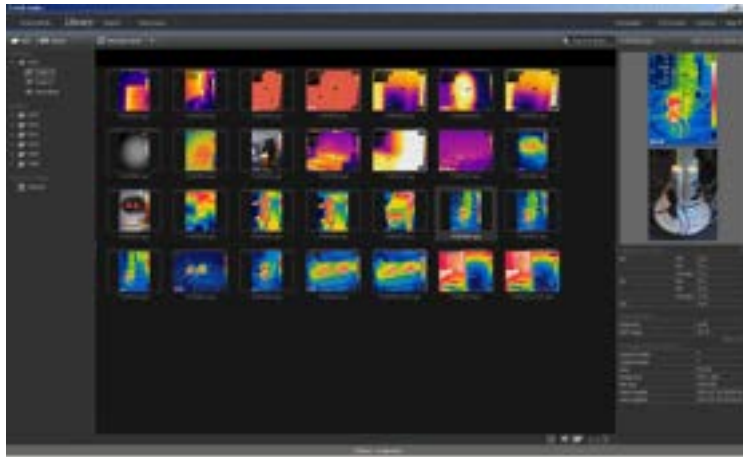

FLIR Tools/Tools+ is a software suite specifically designed to provide an easy way to update your camera and create inspection reports.

Examples of what you can do in FLIR Tools/Tools+ include the following:

- Import images from your camera to your computer.
- Apply filters when searching for images.
- Lay out, move, and resize measurement tools on any infrared image.
- Group and ungroup files.
- Create panoramas by stitching several smaller images into a larger one.
- Create PDF imagesheets of any images of your choice.
- Add headers, footers, and logos to imagesheets.
- Create PDF/Microsoft Word reports for images of your choice.
- Add headers, footers, and logos to reports.
- Update your camera with the latest firmware.

For more information, refer to the User's manual for FLIR Tools/Tools+.

8.2 Workflow

8.2.1 General

When you carry out an infrared inspection you follow a typical workflow. This section gives an example of an infrared inspection workflow.

8.2.2 Figure

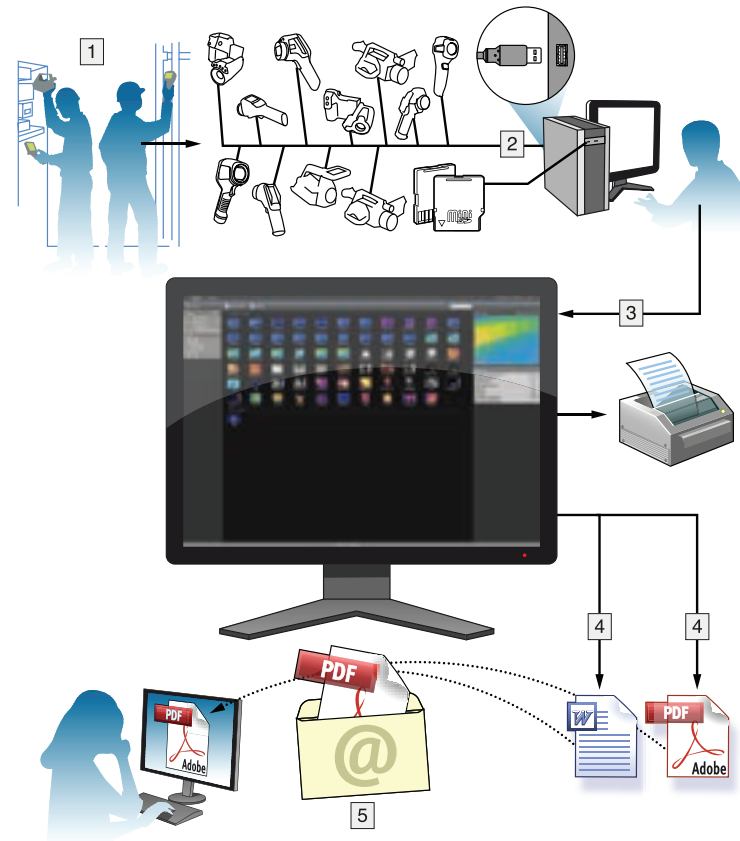

8.2.3 Explanation

1. Use your camera to take your infrared images and/or digital photos.
2. Connect your camera to a PC using a USB connector.
3. Import the images from the camera into FLIR Tools/Tools+.
4. Do one of the following:
 - Create a PDF imagesheet in FLIR Tools.
 - Create a PDF report in FLIR Tools.
 - Create a non-radiometric Microsoft Word report in FLIR Tools+.
 - Create a radiometric Microsoft Word report in FLIR Tools+.
5. Send the report to your client as an attachment to an e-mail.

Using the high-speed interface (HSI)

9.1 General

The high-speed interface (HSI) is included in the FLIR T10xx SC kit. The high-speed interface enables streaming of live video from the FLIR T10xx camera to a PC running the FLIR ResearchIR Max software. The high-speed interface is primarily intended for R&D usage and development purposes. As an example, the camera can capture and stream very rapid processes, which cannot be perceived by the human eye, for later processing and analysis in the PC software. The streamed video is fully radiometric and uncompressed.

9.2 System overview

9.2.1 Figure

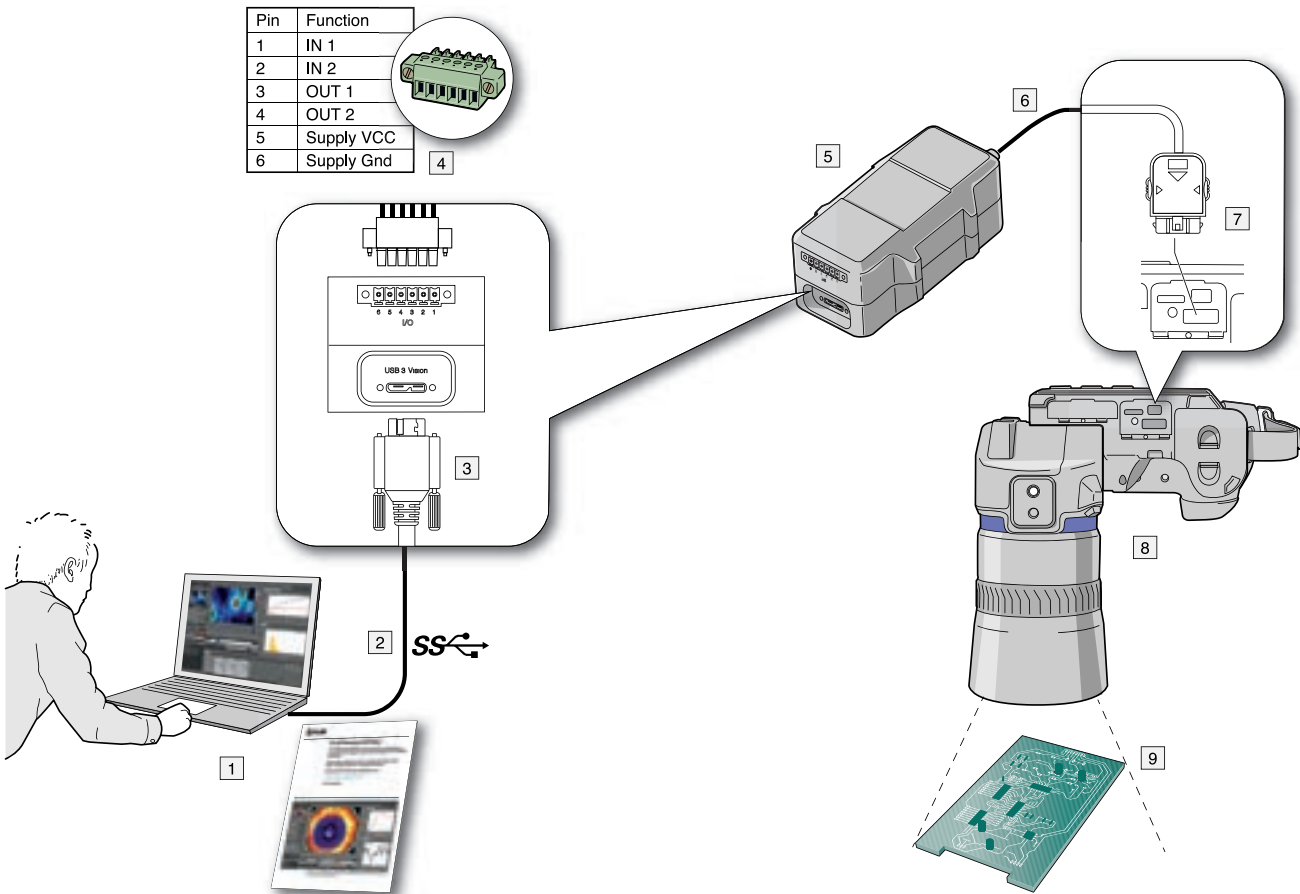

9.2.2 Explanation

1. PC running FLIR ResearchIR Max (a download card with a printed license key is included with the HSI box).
2. USB 3 connection.
3. USB 3 cable connector.
4. Optional digital I/O connector.
5. HSI box
6. High-speed LVDS connection.
7. High-speed interface cable connector.
8. FLIR T10xx camera, optionally with a close-up lens.

9. Object of study.

9.3 Quick start guide

Follow this procedure:

1. Go to <http://support.flir.com/rir4> and download FLIR ResearchIR Max.
2. Install FLIR ResearchIR Max.
3. Start FLIR ResearchIR Max.

When asked for the license key, enter the license key that is printed on the FLIR ResearchIR Max download card. The card is included with the HSI box.

4. Connect the HSI box to the computer using the provided USB 3 cable.
5. Connect the camera to the HSI box using the integrated high-speed interface cable.
6. Start the camera. This displays a start-up dialog box in FLIR ResearchIR Max. If the start-up dialog box is not displayed, go to *View > Startup Dialog*.
7. In the start-up dialog box, click the camera you want to connect to.

For more information about the installation and connection processes, see the FLIR ResearchIR Max manual.

9.4 HSI box indicator LED

Indicator LED status	Explanation
The indicator LED displays a continuous blue light.	The HSI box is operational, and video data is now continuously streamed to the computer.
The indicator LED displays a flashing blue light, with a period time of about 1 second.	The HSI box is connected to the computer, but the link between the camera and the box is not up. Either the cable to the camera is not correctly connected or there is another error on the link.
The indicator LED displays a continuous blue light with short interrupts.	Each interrupt in the continuous light indicates a bit error in the video data stream.

9.5 Digital I/O

For information about the optional Digital I/O connection, see sections 32 *Digital I/O pin configuration*, page 234 and 33 *Digital I/O connection diagram*, page 235.

Product name	Part number
Battery charger, incl. power supply with multi plugs T6xx	T198126
Battery Li-ion 3.7 V, 7.8 Ah, 29 Wh	T199406ACC
Bluetooth Headset	T197771ACC ²
Cigarette lighter adapter kit, 12 VDC, 1.2 m/3.9 ft.	T198509
Close-up lens 3x (51 micron) with case	T199065
FLIR Atlas SDK for .NET	T199233
FLIR Atlas SDK for MATLAB	T199234
FLIR IR Camera Player	DSW-10000
FLIR Reporter Professional (license only)	T198586
FLIR ResearchIR Max + HSDR 4 (hardware sec. dev.)	T198697
FLIR ResearchIR Max + HSDR 4 (printed license key)	T199014
FLIR ResearchIR Max + HSDR 4 Upgrade (printed license key)	T199044
FLIR ResearchIR Max 4 (hardware sec. dev.)	T198696
FLIR ResearchIR Max 4 (printed license key)	T199013
FLIR ResearchIR Max 4 Upgrade (printed license key)	T199043
FLIR ResearchIR Standard 4 (hardware sec. dev.)	T198731
FLIR ResearchIR Standard 4 (printed license key)	T199012
FLIR ResearchIR Standard 4 Upgrade (printed license key)	T199042
FLIR T10xx SC kit	72500-0002
FLIR Tools	T198584
FLIR Tools (MacOS Application)	APP-10004
FLIR Tools Mobile (Android Application)	APP-10002
FLIR Tools Mobile (iPad/iPhone Application)	APP-10003
FLIR Tools+ (download card incl. license key)	T198583
HDMI type C to DVI cable 1.5 m	T910930ACC
HDMI type C to HDMI type A cable 1.5 m	T910891ACC
IR lens f=21.2mm (45°) with case	T199066
IR lens f=36mm (28°) with case	T199064
IR lens f=83.4mm (12°) with case	T199077
Large eyecup	T198497 ²
Memory card SD Card 8 GB	T911650ACC
Neck strap	T198499
Power supply, incl. multi plugs	T910814
Tool belt	T911093
USB cable Std A <-> Micro B	T198533

Note FLIR Systems reserves the right to discontinue models, parts or accessories, and other items, or to change specifications at any time without prior notice.

2. The inclusion of this item is dependent on model.

11.1 General

To prevent strain-related injuries, it is important that you hold the camera ergonomically correctly. This section gives advice and examples on how to hold the camera.

Note

- Always tilt the touch-screen LCD to suit your work position.
- When you hold the camera, make sure that you support the optics housing with your left hand too. This decreases the strain on your right hand.
- Always use the supplied neck strap. See section 12.5 *Neck strap attachment points*, page 30.

11.2 Figure



12.1 View from the right

12.1.1 Figure

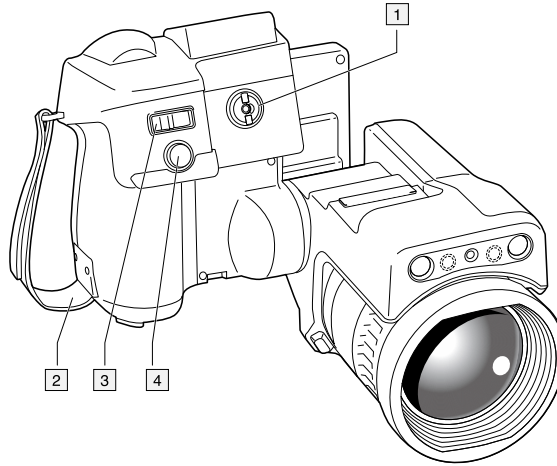

12.1.2 Explanation

1. Knob to change the dioptic correction for the viewfinder.

Note This item is dependent on the camera model.

2. Hand strap.
3. Digital zoom button.
4. Save button (push fully down).

Note The infrared camera can be configured to autofocus when you push the Save button half-way down. To enable the autofocus function of the Save button, select

 (Settings) > Save options & storage > Save button half-press = Autofocus.

12.2 View from the left

12.2.1 Figure

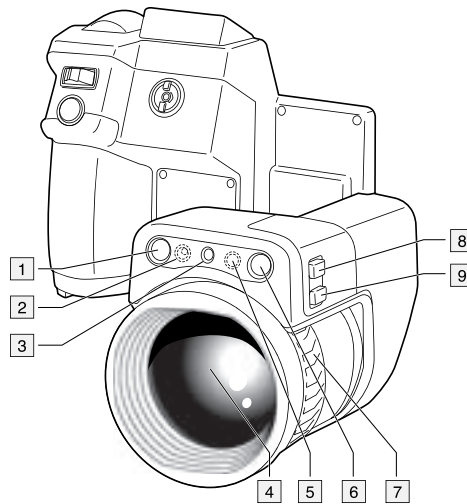

12.2.2 Explanation

1. Digital camera.
2. Camera lamp.
3. Laser pointer.

Note The laser pointer may not be enabled in all markets.

4. Infrared lens.
5. Camera lamp.
6. Digital camera.
7. Focusing ring.

8. Programmable button **P**₂.
9. Button to operate the laser pointer.

12.3 View from the bottom

12.3.1 Figure

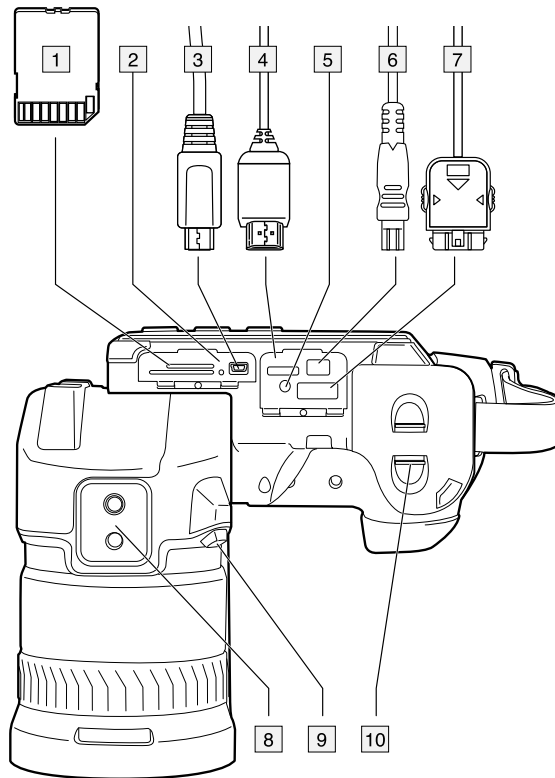

12.3.2 Explanation

1. Memory card.

Note Empty or use a memory card that has not previously been used in another version or type of camera. The cameras may organize files differently on the memory card. There is therefore a risk of losing data if the same memory card is used in different versions or types of cameras.

2. LED indicator showing that the memory card is busy.

Note

- Do not eject the memory card when this LED is flashing.
- Do not connect the camera to a computer when this LED is flashing.

3. USB Micro B cable (to connect the camera to a computer).
4. HDMI cable (for digital video output).
5. Battery condition LED indicator.
6. Power supply cable (to power the camera and charge the battery).
7. High-speed interface cable.
8. Tripod mount.
9. Button to release the lens.
10. Latch to release the battery.

12.4 View from the rear

12.4.1 Figure

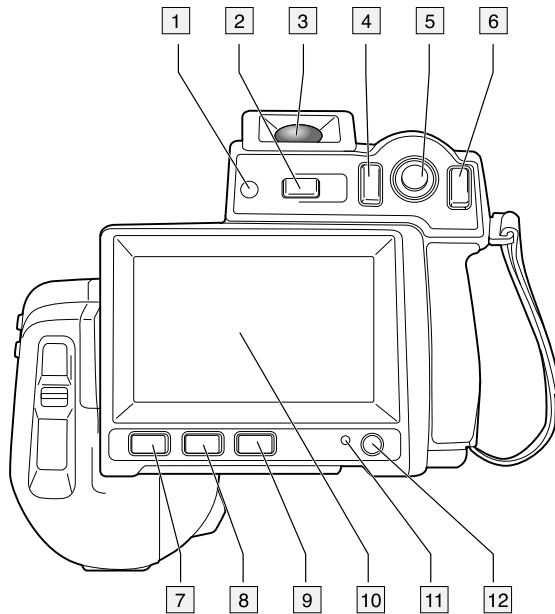

12.4.2 Explanation

1. Sensor that adjusts the touch-screen LCD intensity automatically.

2.  button.

Function:

- Push to switch between touch-screen LCD mode and viewfinder mode.

Note This item is dependent on the camera model.

3. Viewfinder.

Note This item is dependent on the camera model.

4. Programmable button **P**.

5. Joystick with push-button functionality.

Function:

- Move the joystick left/right or up/down to navigate in menus, submenus, and dialog boxes, and to change values in dialog boxes.
- Push the joystick to confirm changes and settings in menus and dialog boxes.

6. Back button .

Function:

- Push to leave dialog boxes and to go back into the menu system.

7. Camera lamp button .

Function:

- Push to turn on or off the camera lamp.

Note The camera lamp must be enabled. Select  (*Settings*) > *Device settings* > *Lamp & laser* > *Enable lamp & laser*.

8.  button.

Function:

- Push to switch between automatic and manual image adjustment mode.

9. Image archive button .

Function:

- Push to open the image archive.
- Push and hold for more than 2 seconds to perform a manual non-uniformity correction (NUC).

10. Touch-screen LCD.

11. Power indicator.

12. On/off button .

Function:

- Push and release to turn on the camera.
- Push and hold for more than 0.5 second to turn off the camera.

12.5 Neck strap attachment points

12.5.1 Figure

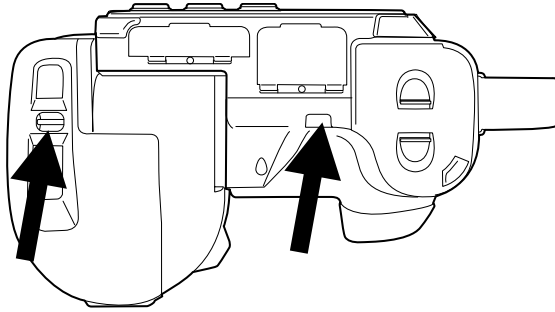

12.6 Battery condition LED indicator

12.6.1 Figure

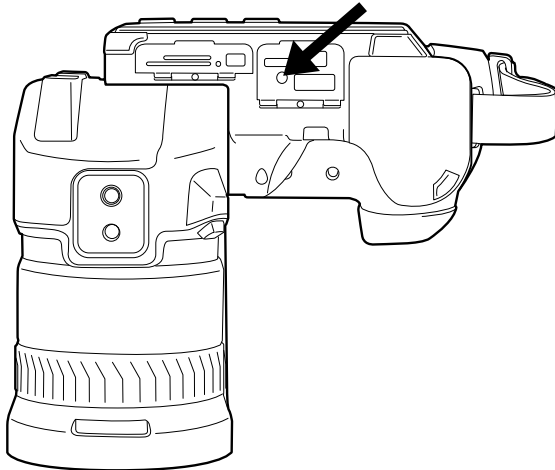

12.6.2 Explanation

Type of signal	Explanation
The green LED flashes twice per second.	The battery is being charged.
The green LED glows continuously.	The battery is fully charged.

12.7 Power LED indicator

12.7.1 Figure

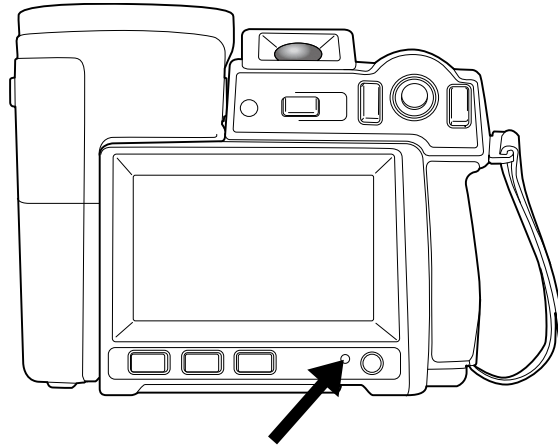

12.7.2 Explanation

Type of signal	Explanation
The LED is off.	The camera is off.
The LED is blue.	The camera is on.

12.8 Laser pointer

12.8.1 Figure

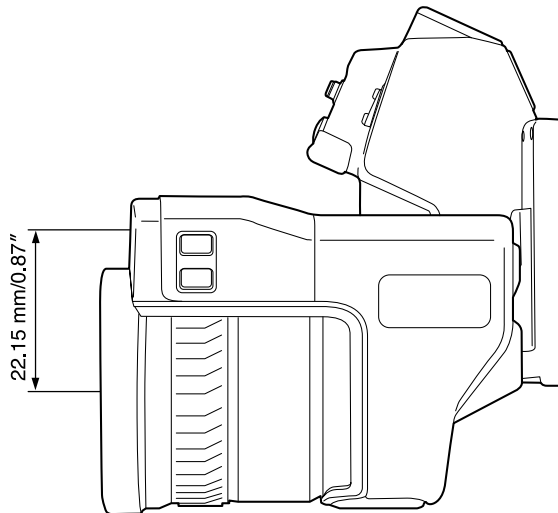





Figure 12.1 This figure shows the difference in position between the laser pointer and the optical center of the infrared lens.

	WARNING
Do not look directly into the laser beam. The laser beam can cause eye irritation.	

Note

- The symbol  is displayed on the screen when the laser pointer is on.
- The laser pointer is enabled by a setting. Select  (*Settings*) > *Device settings* > *Lamp & laser* > *Enable lamp & laser*.

Note The laser pointer may not be enabled in all markets.

12.8.2 Laser warning label

A laser warning label with the following information is attached to the camera:

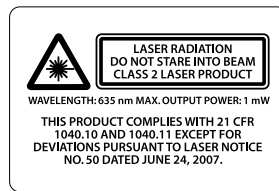
**12.8.3 Laser rules and regulations**

Wavelength: 635 nm. Maximum output power: 1 mW.

This product complies with 21 CFR 1040.10 and 1040.11 except for deviations pursuant to Laser Notice No. 50, dated June 24, 2007.

13.1 General

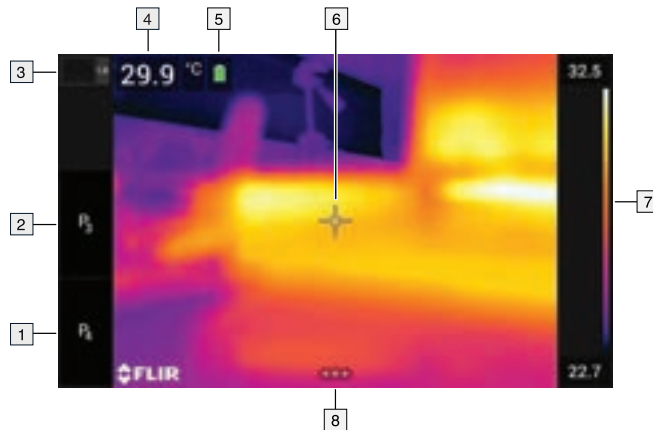

1. Programmable button P4.
2. Programmable button P3.
3. Digital zoom factor.
4. Result table.
5. Status icons.
6. Measurement tool (e.g., spotmeter).
7. Temperature scale.
8. Menu system button.





13.2 Menu system

To display the menu system, push the joystick or tap the menu system button .



1. Recording mode button.
2. Measurement parameters button.
3. Image mode button.
4. Measurement button.
5. Color button.
6. Settings button.
7. Main menu.
8. Submenu.

13.3 Status icons and indicators

	Battery status indicator. <ul style="list-style-type: none"> When the battery status is 20–100%, the indicator is white. When the battery is charging, the indicator is green. When the battery status is below 20%, the indicator is red.
	The remaining storage capacity is below 100 MB.
	A Bluetooth headset is connected.
	External infrared window compensation is enabled.
	The laser is on.

13.4 Swipe-down menu

To open the swipe-down menu, place your finger at the top of the screen and swipe down.

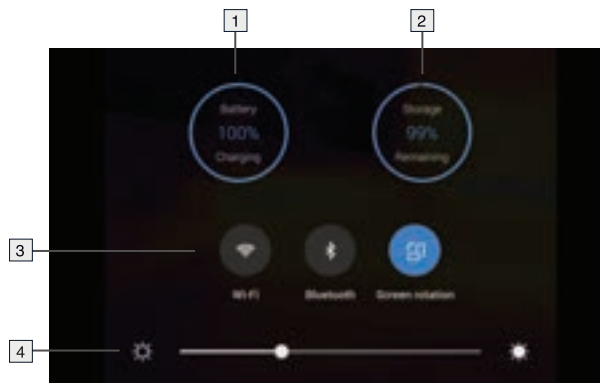

- Battery status indicator.
- Memory card storage status indicator.
- Wi-Fi* button: Touch to enable/disable Wi-Fi. See also section 27 *Configuring Wi-Fi*, page 98.
 - Bluetooth* button: Touch to enable/disable Bluetooth. See also section 26 *Pairing Bluetooth devices*, page 97.
 - Screen rotation* button: Touch to enable/disable screen rotation.
- Screen brightness slider: Used to control the brightness of the screen.

13.5 Image overlay information

The image information consists of items such as the date, emissivity, and atmospheric temperature. All image information is saved in the image file and can be viewed in the image archive. You can also choose to display selected items as image overlay information. All image overlay information displayed on the live image will also be displayed on saved images. For more information, see sections section 29.1.4 *Device settings*, page 102 and 18.8 *Hiding all overlay*, page 69.



14.1 General

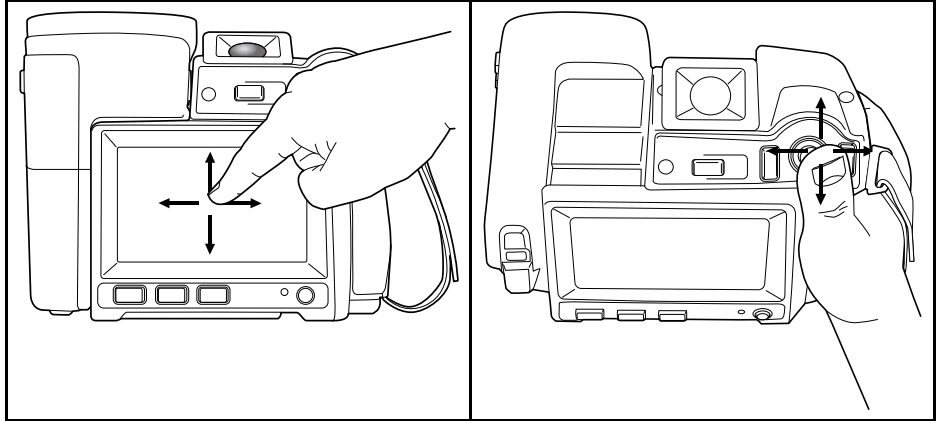

The figure above shows the two ways to navigate the menu system in the camera:

- Using the index finger or a stylus pen specially designed for capacitive touch usage to navigate the menu system (left).
- Using the joystick to navigate the menu system (right) and the back button.

You can also use a combination of the two.

In this manual, it is assumed that the joystick is used, but most tasks can also be carried out using the index finger or a stylus pen.

14.2 Navigating using the joystick

You navigate the menu system by using the joystick and the back button:

- To display the menu system, push the joystick.
- To navigate in menus, submenus, and dialog boxes, and to change values in dialog boxes, move the joystick up/down or left/right.
- To confirm changes and settings in menus and dialog boxes, push the joystick.
- To leave dialog boxes and to go back in the menu system, push the back button .

15.1 Charging the battery



WARNING

Make sure that you install the socket-outlet near the equipment and that it is easy to get access to.

Note You must charge the battery for 4 hours before you start using the camera for the first time.

15.1.1 Using the power supply to charge the battery when it is inside the camera

15.1.1.1 Procedure

Follow this procedure:

1. Put the battery into the camera battery compartment.
2. Connect the power supply cable plug to the power connector on the camera.
3. Connect the power supply mains-electricity plug to a mains socket.
4. To check the status of the battery charging, do one of the following:
 - If the camera is turned on: Place your finger at the top of the screen and swipe down. The battery status is displayed on the swipe-down menu.
 - If the camera is turned off: The battery charging indicator is temporarily displayed on the screen.
5. It is good practice to disconnect the power supply cable plug when the green light of the battery condition LED indicator is continuous.

15.1.2 Using the stand-alone battery charger to charge the battery

15.1.2.1 Explanation

Type of signal	Explanation
The blue LED flashes.	The battery is being charged.
The blue LED glows continuously.	The battery is fully charged.

15.1.2.2 Procedure

Follow this procedure:

1. Put the battery in the battery charger.
2. Connect the power supply cable plug to the connector on the battery charger.
3. Connect the power supply mains-electricity plug to a mains socket.
4. It is good practice to disconnect the power supply cable plug when the blue LED on the battery charger is glowing continuously.

15.2 Turning on the camera

15.2.1 Procedure

Follow this procedure:

1. To turn on the camera, push and release the On/off button .

15.3 Turning off the camera

15.3.1 Procedure

Follow this procedure:

1. To turn off the camera, push and hold the On/off button  for more than 0.5 second.

Note Do not remove the battery to turn off the camera.

15.4 Adjusting the viewfinder's dioptic correction (sharpness)

15.4.1 Figure

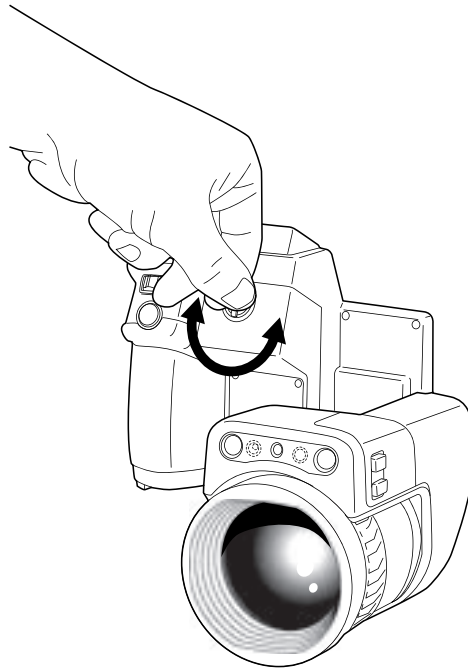

CAUTION

Applicability: Cameras with a viewfinder.

Make sure that the beams from the intensive energy sources do not go into the viewfinder. The beams can cause damage to the camera. This includes the devices that emit laser radiation, or the sun.

Note This item is dependent on the camera model.

15.4.2 Procedure

Follow this procedure:

1. Push the  button to switch from touch-screen LCD mode to viewfinder mode.
2. To adjust the viewfinder's dioptic correction, look through the viewfinder and rotate the adjustment knob clockwise or counter-clockwise for the best sharpness.

Note

- Maximum dioptic correction: +2.
- Minimum dioptic correction: -2.

15.5 Adjusting the angle of the lens

15.5.1 Figure

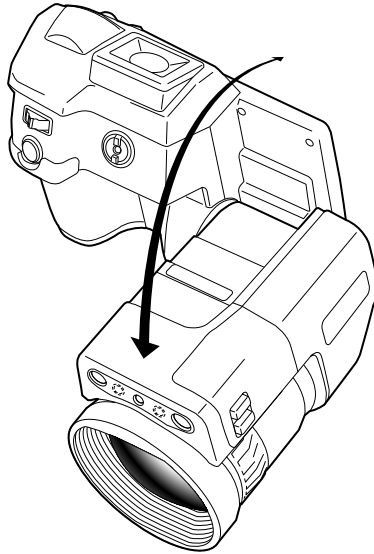

15.6 Adjusting the infrared camera focus manually

15.6.1 Figure

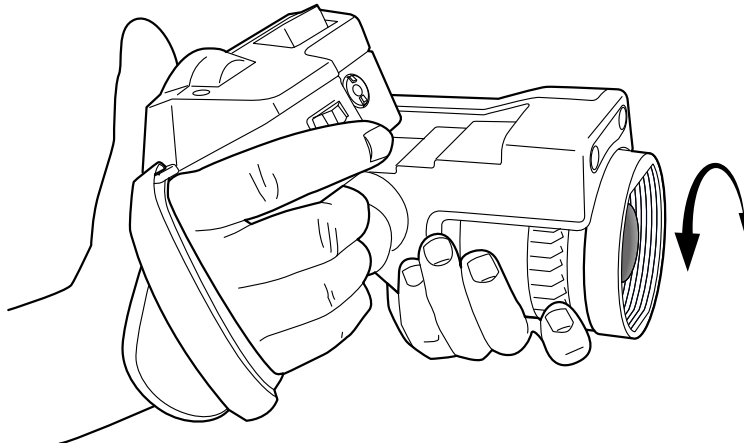

15.6.2 Procedure

Follow this procedure:

1. Do one of the following:
 - For far focus, rotate the focus ring clockwise (looking at the touch-screen LCD side of the camera).
 - For near focus, rotate the focus ring counter-clockwise (looking at the touch-screen LCD side of the camera).

Note

- Do not touch the lens surface when you adjust the infrared camera focus manually. If this happens, clean the lens according to the instructions in 35.2 *Infrared lens*, page 239.
- The focus ring can be rotated infinitely, but only a certain amount of rotation is needed when focusing.
- The response of the focus mechanism is progressive, meaning that a faster rotation of the focus ring gives a disproportional higher speed of focus change. This allows for both fine adjustment with a relatively large (but slow) rotation and rapid change with a smaller (but faster) rotation. Furthermore, for a very slow rotation, the lens moves in very small, discrete steps (which you can hear), allowing for a controlled fine adjustment of the focus.

15.7 Autofocusing the infrared camera

15.7.1 General

The infrared camera can be configured to autofocus when you push the Save button half-way down.

15.7.2 Figure

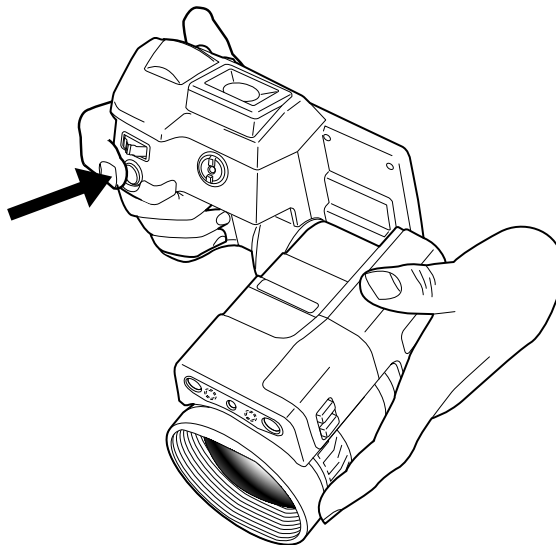

15.7.3 Procedure

Follow this procedure:

1. To enable the autofocus function of the Save button, select  (*Settings*) > *Save options & storage* > *Save button half-press = Autofocus*.
2. To autofocus, push the Save button half-way down.

Note You can also assign the autofocus function to the programmable button **P** or **P₂**. For more information, see section 15.11 *Assigning functions to the programmable buttons*, page 42.

15.8 Continuous autofocus

15.8.1 General

The infrared camera can be set up to perform continuous autofocusing.

Note

- In this mode, the digital camera is used, which means that continuous autofocus will not work in darkness.
- When continuous autofocus is enabled, it is not possible to manually adjust the focus by rotating the focus ring.
- To stop continuous autofocus (e.g., to stabilize the focus before saving an image), push the Save button half-way down.

15.8.2 Procedure

Follow this procedure:

1. Push the joystick to display the menu system.
2. Use the joystick to go to  (*Settings*).
3. Push the joystick to display the *Settings* menu.
4. Select *Device settings* and push the joystick.
5. Select *Continuous autofocus* and push the joystick.
6. Select *On* and push the joystick.

Note You can also assign the function *Continuous autofocus* to one of the programmable buttons. For more information, see section 15.11 *Assigning functions to the programmable buttons*, page 42.

15.9 Operating the laser pointer**WARNING**

Do not look directly into the laser beam. The laser beam can cause eye irritation.

Note The laser pointer is enabled by a setting. Select  (*Settings*) > *Device settings* > *Lamp & laser* > *Enable lamp & laser*.

Note The laser pointer may not be enabled in all markets.

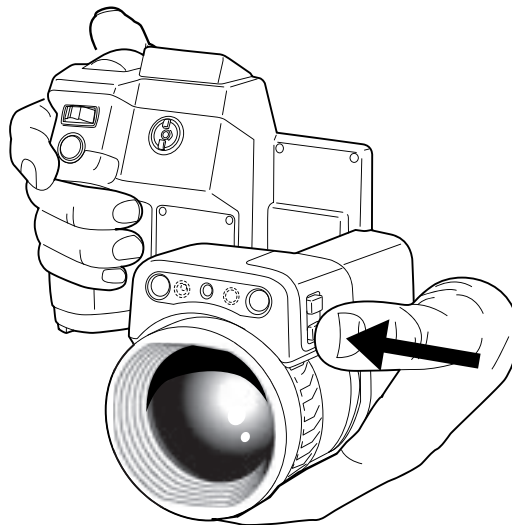
15.9.1 Figure**15.9.2 Procedure**

Follow this procedure:

1. To turn on the laser pointer, push and hold the laser button.
2. To turn off the laser pointer, release the laser button.

Note The symbol  is displayed on the screen when the laser pointer is on.

15.10 Using the digital zoom function

15.10.1 General

The current zoom factor is displayed in the upper left corner of the screen.

In preview/edit mode, it is possible to pan a zoomed image by touching the screen.

15.10.2 Figure

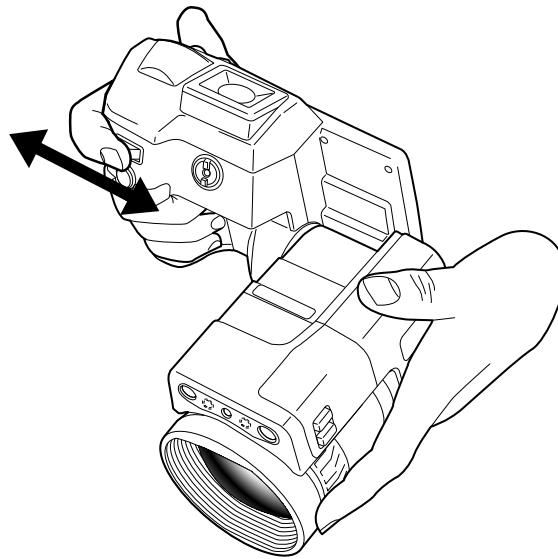

15.10.3 Procedure

Follow this procedure:

1. To zoom, push the zoom button left or right.

Note You can also zoom the image by touching the screen. For more information, see section 16.8 *Zooming an image*, page 58.

15.11 Assigning functions to the programmable buttons

15.11.1 General

There are four individually programmable buttons: two hardware buttons, and two software buttons on the screen.



1. Programmable button **P**.
2. Programmable button **P₂**.
3. Programmable button P3 (function assigned).
4. Programmable button P4.

You can assign different functions to the programmable buttons. You can, for example, use a programmable button to easily switch between two settings you use often. You can also choose to define two different setups for saving and previewing: the usual setup for the Save button (which is defined by the *Save options and storage* settings, see section 29.1.3 *Save options & storage*, page 101) and another setup for a programmable button.

Available options for all programmable buttons:

- *No action*: This is the default setting. Nothing will happen when you push/press the button.
- *Hide image overlay graphics*: Switch between hide/show all overlay graphics and image overlay information. For more information, see section 18.8 *Hiding all overlay*, page 69.
- *Calibrate*: Perform a manual NUC. For more information, see section 18.7 *Performing a non-uniformity correction (NUC)*, page 69.
- *Auto-adjust the manual temperature scale*: Perform an automatic adjustment of the image while remaining in manual image adjustment mode.
- *Switch Thermal <> Digital camera*: Switch between the image modes *Thermal* and *Digital camera*. For more information, see section 19 *Working with image modes*, page 71.
- *Switch Thermal <> Thermal MSX*: Switch between the image modes *Thermal* and *Thermal MSX*. For more information, see section 19 *Working with image modes*, page 71.
- *Switch 1x zoom <> Max zoom*: Switch between the digital zoom factor of 1x and maximum zoom.
- *Switch camera flash On <> Off*: Switch between the enabled/disabled camera flash functions. For more information, see section 15.12 *Using the camera lamp as a flash*, page 44.

Note The flash function will not be activated if the setting *Lamp & laser* is set to the option *Disable all*. For more information, see section 29.1.4 *Device settings*, page 102.

- *Switch single shot <> Video*: Switch between the recording modes *Single shot* and *Video*.

- *Switch between two latest palettes*: Switch between the two last-used color palettes. For more information, see section 18.5 *Changing the color palette*, page 67.
- *Switch temperature range*: Cycle through the camera temperature ranges. For more information, see section 29.1.2 *Camera temperature range*, page 101.

Additional options for the hardware buttons **P** and **P₂**:

- *Autofocus*: One-shot autofocus of the infrared camera.
- *Continuous autofocus*: Switch between the enabled/disabled continuous autofocus functions.
- *Switch screen rotation On <> Off*: Switch between enabled/disabled screen rotation.
- *Save*: Save an image.
- *Save + Prompt for note*: Save an image and display the note annotation tool.
- *Save + Prompt for table*: Save an image and display the table annotation tool.
- *Save + Prompt for voice annotation*: Save an image and display the voice annotation tool.
- *Save + Prompt for sketch*: Save an image and display the sketch annotation tool.
- *Save + Select annotation from menu*: Save an image and display the annotation tool menu.
- *Preview*: Display a preview image.
- *Preview + Prompt for note*: Display a preview image and the note annotation tool.
- *Preview + Prompt for table*: Display a preview image and the table annotation tool.
- *Preview + Prompt for voice annotation*: Display a preview image and the voice annotation tool.
- *Preview + Prompt for sketch*: Display a preview image and the sketch annotation tool.
- *Preview + Select annotation from menu*: Display a preview image and the annotation tool menu.

15.11.2 Procedure

Follow this procedure:

1. Push/press and hold the programmable button. This displays the *Programmable button* menu.
2. Move the joystick up/down to select one of the functions. Push the center of the joystick to confirm.

15.12 Using the camera lamp as a flash

15.12.1 General

The camera lamp can be used as a flash for the digital camera. When the flash function is activated, the camera lamp will flash when an image is saved by pushing the Save button fully down.

You can also turn on the camera lamp to use it as a flashlight.

15.12.2 Procedure

Follow this procedure:

1. Push the joystick to display the menu system.
2. Use the joystick to go to  (*Settings*).
3. Push the joystick to display the *Settings* menu.
4. Select *Device settings* and push the joystick.
5. Select *Lamp & laser* and push the joystick.

6. Do one of the following:

- To enable the camera lamp function, select *Enable lamp & laser* and push the joystick. To turn on/off the camera lamp, push the lamp button .
- To enable the flash function, select *Enable lamp & laser + Use lamp as flash* and push the navigation pad.
- To disable the camera lamp and flash functions, select *Disable all* and push the navigation pad.

Note You can also assign the function *Switch camera flash On <-> Off* to one of the programmable buttons. For more information, see section 15.11 *Assigning functions to the programmable buttons*, page 42.

15.13 Moving files to a computer

15.13.1 General

When you save an image or video clip in the image archive of the camera, the file is stored on the memory card.

You can connect the camera to a computer, using a USB cable. Once connected, you can move the image and video files from the memory card to the computer.

15.13.2 Procedure

Follow this procedure:

1. Connect a USB cable to the USB Micro B connector at the bottom of the camera.

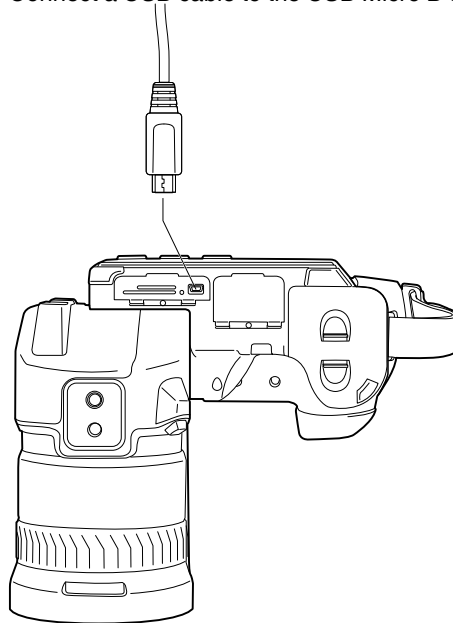

2. Connect the other end of the USB cable to the computer.
3. Turn on the camera.
4. Do one of the following:

- Move the files to the computer using a drag-and-drop operation in Microsoft Windows Explorer.

Note Moving a file using a drag-and-drop operation does not delete the file in the camera.

- Import the images into FLIR Tools/Tools+ or FLIR Report Studio.

15.14 Changing lenses

Note Do not touch the lens surface when you change lenses. If this happens, clean the lens according to the instructions in 35.2 *Infrared lens*, page 239.

Follow this procedure:

1. Take a firm grip around the outermost part of the lens.

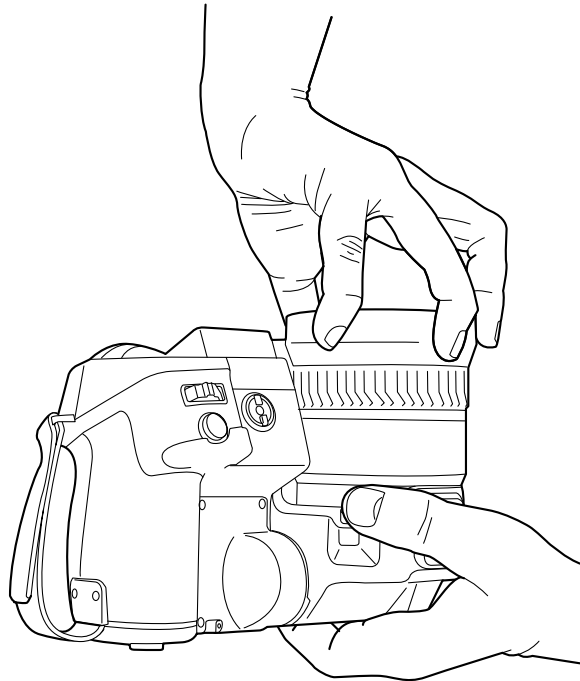

2. Push the release button and rotate the lens 45° counter-clockwise.

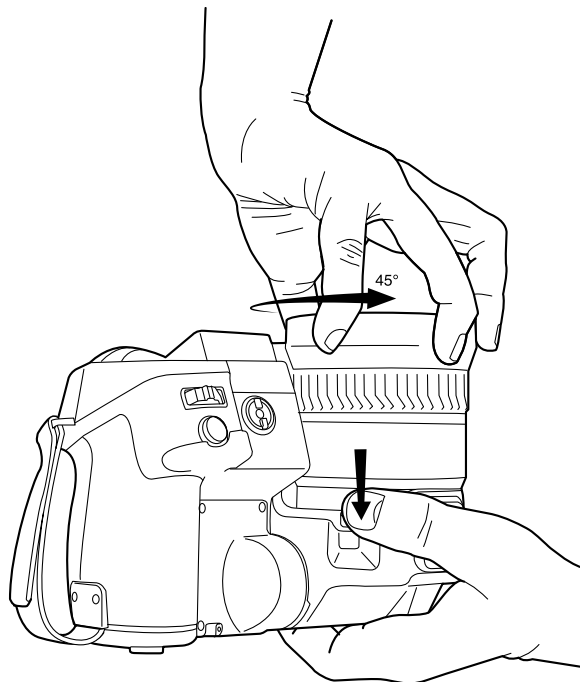

-
3. Carefully pull out the lens from the lens bayonet mount.

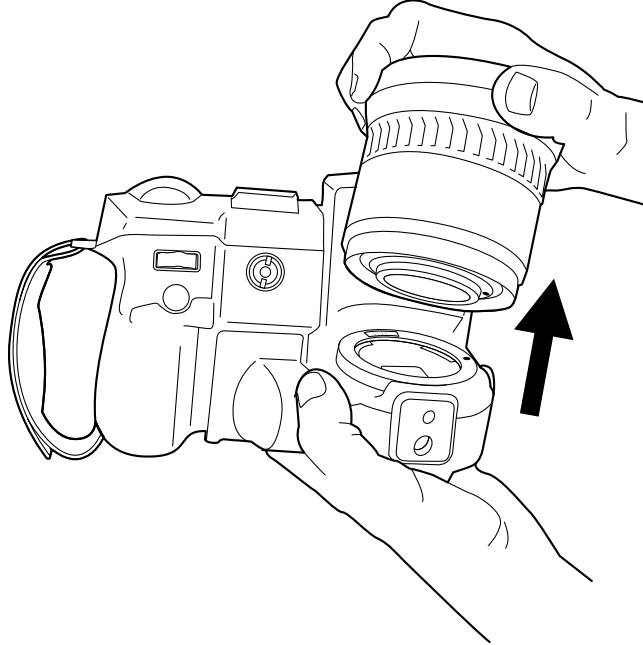

4. The infrared detector is now fully exposed. Do not touch this surface. If you see dust on the detector, follow the instructions in 35.3 *Infrared detector*, page 240.

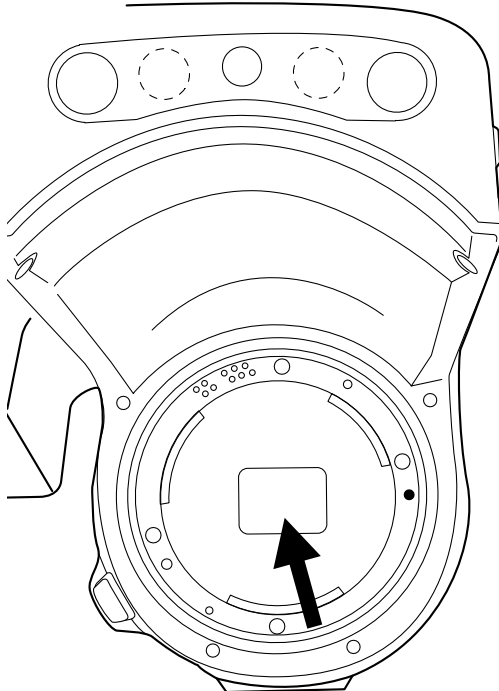

-
5. Note the index marks on the lens bayonet mount and on the lens.

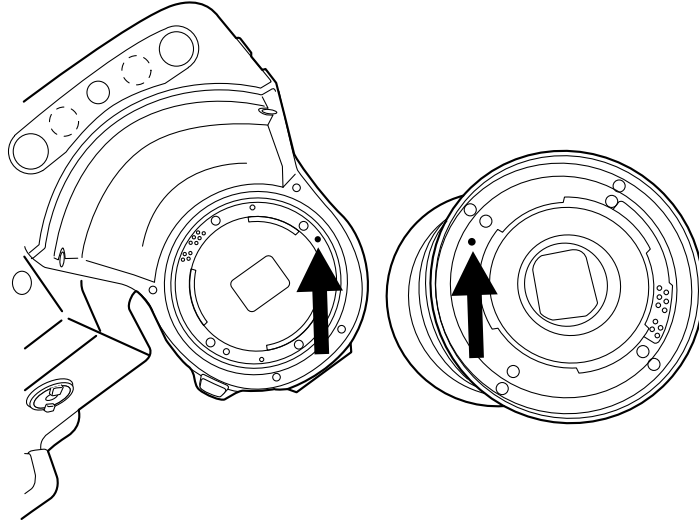

6. Align the lens correctly to the bayonet mount. Carefully push the lens into position.

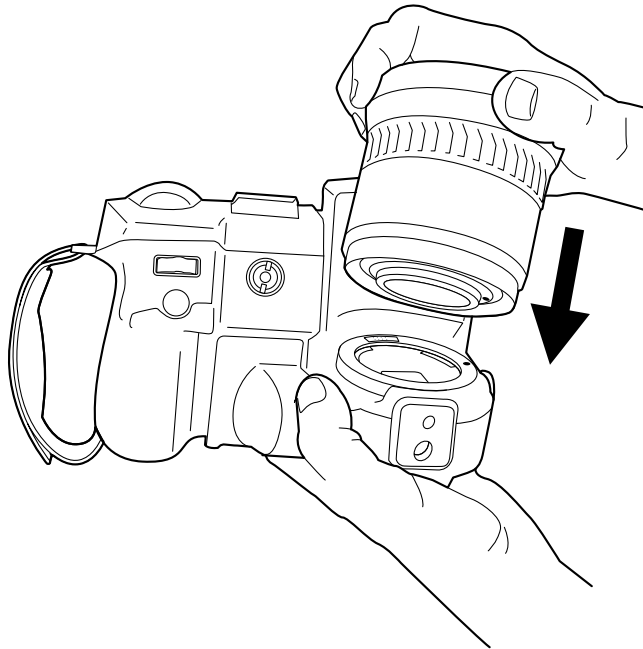

7. Rotate the lens 45° clockwise. The lens makes a click when it locks in place.

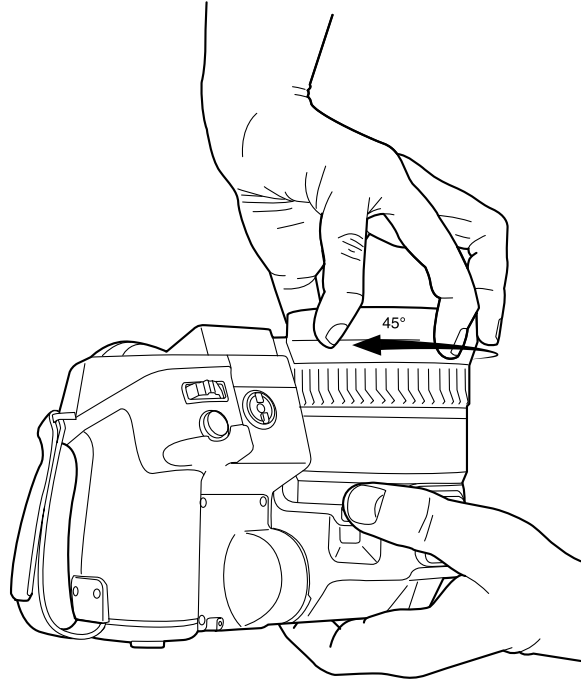

15.15 Using the close-up lens

15.15.1 General

If you need to look at small objects very close up, you can attach the close-up lens to the infrared lens.

When the close-up lens is attached, the digital camera and the infrared camera do not see the same scene. This means that functions that are based on content captured by the digital camera cannot be used, e.g., continuous autofocus and some image modes.

When using the close-up lens, keep the following in mind. (For instructions, see section 15.15.2 *Attaching the close-up lens*, page 49.)

- For best performance, adjust the focus to infinity.
- The working distance for the close-up lens is 97 mm. (The working distance is the distance between the front of the lens and the closest surface of the object when the object is in sharp focus.)
- You must activate the global parameter *External IR window compensation*.
- Only use the *Thermal* image mode.
- Deactivate continuous autofocus.
- Do not use the laser pointer.

Note The close-up lens can only be used with the infrared lens $f = 36$ mm (28°).

15.15.2 Attaching the close-up lens

Note Do not touch the lens surfaces when you attach the close-up lens. If this happens, clean the lens according to the instructions in 35.2 *Infrared lens*, page 239.

Follow this procedure:

1. Before attaching the close-up lens, adjust the focus to infinity by doing the following:
 - 1.1. Aim the camera toward a distant object (more than 40 m (130') away).
 - 1.2. Autofocus the camera (see section 15.7 *Autofocusing the infrared camera*, page 40) or adjust the focus manually (see section 15.6 *Adjusting the infrared camera focus manually*, page 39).

Note Once the focus is set to infinity, be careful when you continue with the procedure. Make sure you do not rotate the focusing ring by mistake.

2. Remove the outermost rubber protection from the infrared lens.

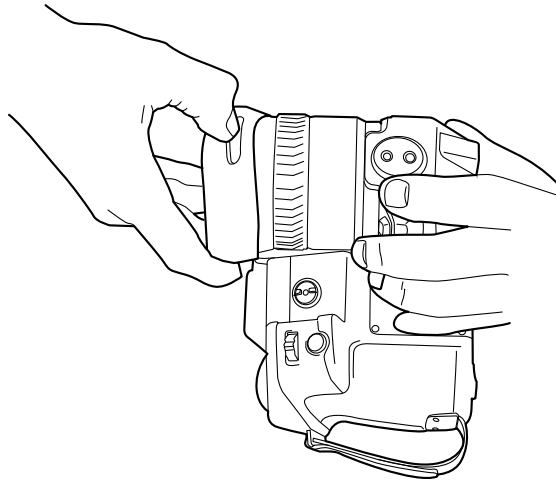



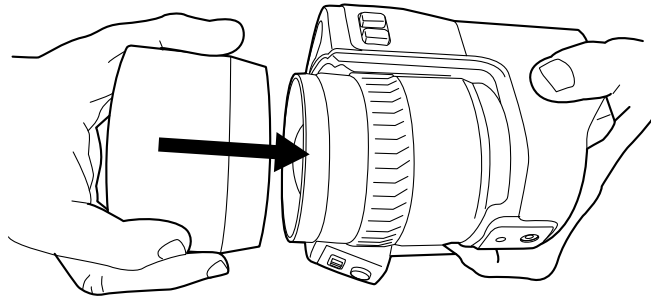

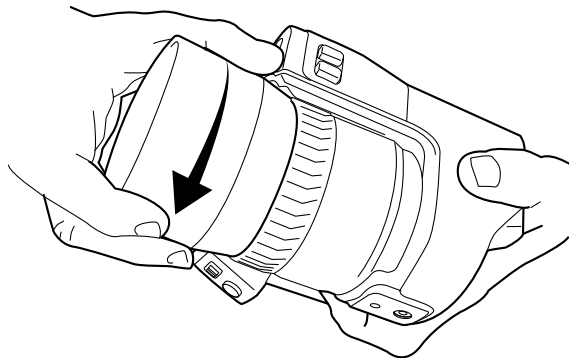

3. Align the close-up lens with the infrared lens. Carefully push the close-up lens into position.



4. Turn the close-up lens clockwise until it stops.



-
5. Activate the global parameter *External IR window compensation* by doing the following:
 - 5.1. Push the joystick to display the menu system.
 - 5.2. Select  (*Measurement parameters*) and push the joystick. This displays a submenu.
 - 5.3. Select  (*External IR window compensation*) and push the joystick. This displays a dialog box.
 - 5.4. In the dialog box, define the settings for the infrared window compensation:
 - *Turn compensation on/off*: Select *On*.
 - *Temperature*: Select the temperature of the close-up lens.
 - *Transmission*: Select 0.89, which is a typical transmission value for the close-up lens.
 - 5.5. The status icon  is now displayed.
 6. Select the image mode *Thermal* by doing the following:
 - 6.1. Push the joystick to display the menu system.
 - 6.2. Select  (*Image mode*) and push the joystick. This displays a submenu.
 - 6.3. Select  (*Thermal*) and push the joystick.
 7. Deactivate continuous autofocus by selecting  (*Settings*) > *Device settings* > *Continuous autofocus* = *Off*.

15.15.3 Removing the close-up lens

Note Do not touch the lens surfaces when you remove the close-up lens. If this happens, clean the lens according to the instructions in 35.2 *Infrared lens*, page 239.

Follow this procedure:

1. Turn the close-up lens counter-clockwise until it separates from the infrared lens.

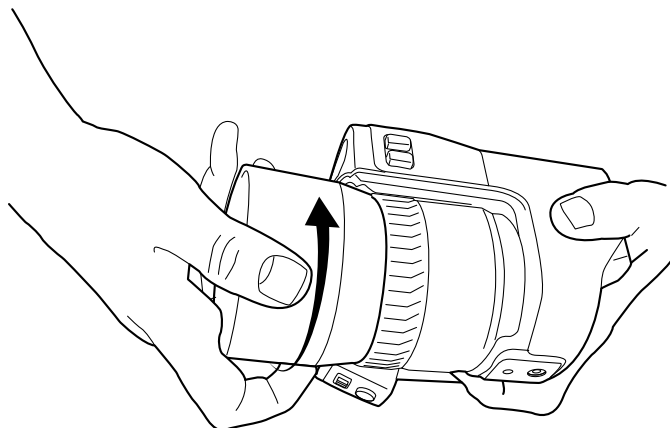

2. Carefully pull out the close-up lens from the infrared lens.

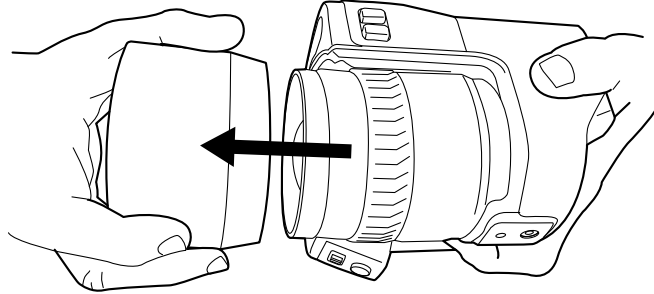

3. Note the grooves on the infrared lens and their counterparts on the inside of the rubber protection.

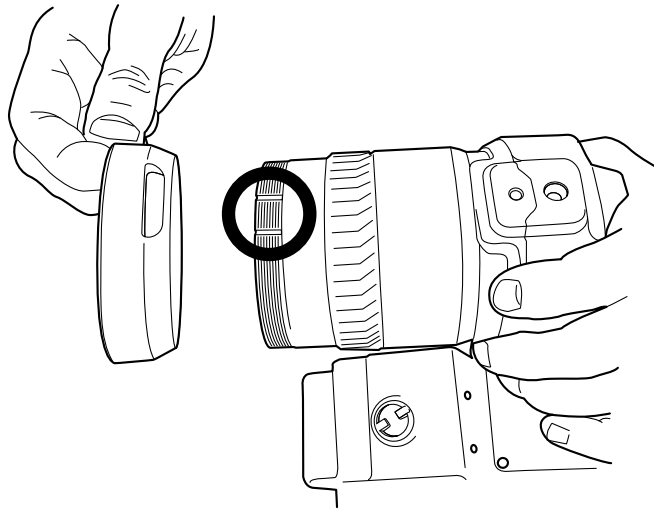

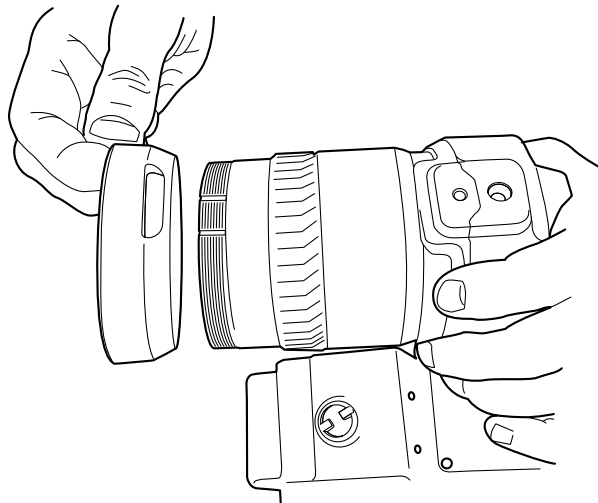

4. Align the rubber protection with the infrared lens.

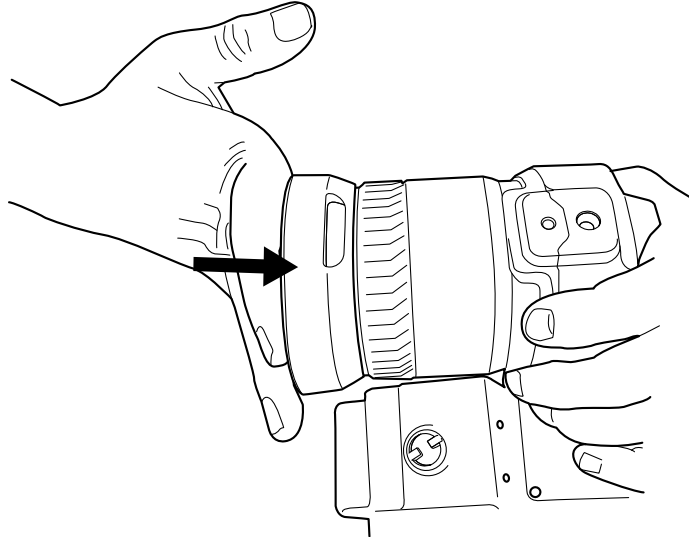

5. Push the rubber protection into position.



6. Deactivate the global parameter *External IR window compensation* by doing the following:
- 6.1. Push the joystick to display the menu system.
 - 6.2. Select  (*Measurement parameters*) and push the joystick. This displays a submenu.
 - 6.3. Select  (*External IR window compensation*) and push the joystick. This displays a dialog box.
 - 6.4. In the dialog box, select *Turn compensation on/off = Off*.

15.16 Calibrating the compass

It is recommended that the compass is calibrated every time you move the camera to a new location.

15.16.1 Procedure

Follow this procedure:

1. Push the joystick to display the menu system.
2. Use the joystick to go to  (*Settings*).
3. Push the joystick to display the *Settings* menu.
4. Select *Device settings* and push the joystick.
5. Depending on the camera configuration, select *Wireless & geolocation*, *Wireless*, or *Geolocation* and push the joystick.
6. Select *Compass* and push the joystick.
7. If the *Compass* check box is unchecked, push the joystick to enable the compass.
8. Select *Calibrate compass* and push the joystick. Follow the on-screen instructions.

Note You must rotate the camera slowly.



16.1 About image files

16.1.1 General

When you save an image, the camera saves an image file that includes all thermal and visual information. This means that you can open an image file at a later time and, for example, select another image mode, apply color alarms, and add measurement tools.

The image *.jpg file is fully radiometric and saved lossless, which enables full post-processing in image analysis and reporting software from FLIR Systems. There is also a regular *.jpg component (lossy) for convenient viewing in non-FLIR Systems software (e.g., Microsoft Explorer).

Note

- The camera can also be configured to save an extra low-resolution visual image as a separate file. This can be convenient if you are not using a post-processing software.
Select  (Settings) > Save options & storage > Photo as separate JPEG = On.
- When the *Digital camera* image mode is selected, a high-resolution digital image is stored when an image is saved. However, no thermal information is stored. For more information, see section 19 *Working with image modes*, page 71.
- You can choose to turn off the digital camera. This can, for example, be required in restricted areas and in confidential (e.g., doctor/patient) situations. Select  (Settings) > Save options & storage > Digital camera = Off. When the digital camera is off, features that require visual information, such as the image modes *Thermal MSX* and *Picture in picture*, are disabled.

16.1.2 File-naming convention

The default naming convention for image files is FLIRxxxx.jpg, where xxxx is a unique counter.

It is also possible to save images with a date prefix added to the filename. However, these files may not automatically be detected by third-party applications. For more information, see the setting *File naming format* in section 29.1.3 *Save options & storage*, page 101.

16.1.3 Storage capacity

When you save an image, the camera stores the image file on the memory card.

The size of an image file (with no annotations) is typically less than 1000 kB. Thus, the capacity of a 8 GB memory card is approximately 8000 images.

Note Empty or use a memory card that has not previously been used in another version or type of camera. The cameras may organize files differently on the memory card. There is therefore a risk of losing data if the same memory card is used in different versions or types of cameras.

16.1.4 About UltraMax

UltraMax is an image enhancement feature that increases the image resolution and lowers the noise, making small objects easier to see and measure. An UltraMax image is twice as wide and high as an ordinary image.

When an UltraMax image is captured by the camera, several ordinary images are saved within the same file. Capturing all the images can take up to 1 second. To fully utilize UltraMax, the images need to be slightly different, which can be accomplished by a slight movement of the camera. You should hold the camera firmly in your hands (do not put it on a tripod), which will make these images vary just a little during the capture. Correct

focus, a high-contrast scene, and a non-moving target are other conditions that help to achieve a good-quality UltraMax image.

At present, only FLIR Tools/Tools+ and FLIR ResearchIR Max have the ability to process UltraMax images. Other FLIR software will treat the image as a regular image.

To configure the camera for UltraMax, select  (Settings) > Save options & storage > Image resolution = UltraMax.

16.2 Saving an image

16.2.1 General

You can save images to the memory card.

16.2.2 Procedure

Follow this procedure:

1. To save an image, push the Save button fully down.

Note Depending on the settings in  (Settings) > Save options & storage, the following may happen:

- A preview image is displayed before the image is saved.
- An annotation tool or the annotation menu is displayed when the image has been saved.

16.3 Previewing an image

16.3.1 General

You can preview an image before you save it. This enables you to see if the image contains the information you want before you save it. You can also adjust and edit the image.

Note The camera must be configured to display a preview image before saving. Select  (Settings) > Save options & storage > Preview image before saving = On.

16.3.2 Procedure

Follow this procedure:

1. To preview an image, push the Save button fully down. This displays the preview.
2. Manual image adjustment mode is now active. For image adjustment instructions, see section 18.3 *Adjusting the infrared image*, page 63.
3. To edit the image, push the joystick. This displays a context menu. For editing instructions, see section 16.5 *Editing a saved image*, page 56.
4. Do one of the following:
 - To save the image, push the Save button fully down.
 - To exit preview mode without saving, push the back button .





16.4 Opening a saved image

16.4.1 General

When you save an image, the image file is stored on the memory card. To display the image again, open it from the image archive (*Gallery*).

16.4.2 Procedure

Follow this procedure:

1. Push the image archive button . This displays the *Gallery* with one or more folders.
2. Select a folder and push the joystick.
3. Select the image you want to view and push the joystick.
4. Do one or more of the following:
 - To view the previous/next image, move the joystick left/right.
 - To display a toolbar at the top of the screen, push the joystick. Do one or more of the following:
 - To switch between an infrared image and a visual image, select the  icon and push the joystick.
 - To edit the image, delete the image, create a PDF report, display information, or add annotations, select the  icon and push the joystick. This displays a menu to the right.
 - To return to the folder overview, push the back button .
 - To return to the live image, push the image archive button .









16.5 Editing a saved image

16.5.1 General

You can edit a saved image. You can also edit an image in preview mode.

16.5.2 Procedure

Follow this procedure:

1. Push the image archive button . This displays the *Gallery*.
2. Select a folder and push the joystick.
3. Select the image you want to edit and push the joystick.
4. Push the joystick to display the top toolbar.
5. On the top toolbar, select the  icon and push the joystick.
6. On the right toolbar, select the  icon and push the joystick. This opens the image in edit mode.
7. Manual image adjustment mode is now active. For image adjustment instructions, see section 18.3 *Adjusting the infrared image*, page 63.
8. Push the joystick. This displays a context menu.
 - Select  (*Cancel*) to exit edit mode.
 - Select  (*Measurement parameters*) to change the global parameters.
 - Select  (*Image mode*) to change the image mode.
 - Select  (*Measurement*) to add a measurement tool.
 - Select  (*Color*) to change the color palette or set a color alarm.
 - Select  (*Save*) to save and exit edit mode.

16.5.3 Related topics

- 18.6 *Changing the measurement parameters*, page 69.
- 19 *Working with image modes*, page 71.
- 20 *Working with measurement tools*, page 74.
- 18.5 *Changing the color palette*, page 67.
- 21 *Working with color alarms and isotherms*, page 83.



16.6 Displaying image information

16.6.1 General

The image information consists of items such as the date, emissivity, and atmospheric temperature. When you save an image, the image information is saved in the image file and can be viewed in the image archive (*Gallery*).

16.6.2 Procedure

Follow this procedure:

1. Push the image archive button . This displays the *Gallery*.
2. Select a folder and push the joystick.
3. Select an image and push the joystick.
4. Push the joystick to display the top toolbar.
5. On the top toolbar, select the  icon and push the joystick.
6. On the right toolbar, select the  icon and push the joystick. This displays the image information.

16.7 Creating a PDF report in the camera

16.7.1 General



You can create a PDF report and save it to the memory card. You can then transfer the PDF report to a computer, using for example FLIR Tools/Tools+, and send the report to a customer.

16.7.2 Naming convention

The naming convention for report files is REPORTxxxx.jpg, where xxxx is a unique counter.

16.7.3 Procedure

Follow this procedure:

1. Push the image archive button . This displays the *Gallery*.
2. Select a folder and push the joystick.
3. Select an image and push the joystick.
4. Push the joystick to display the top toolbar.
5. On the top toolbar, select the  icon and push the joystick.
6. On the right toolbar, select the  icon and push the joystick. The created report will be available in the *Gallery*.

16.8 Zooming an image

16.8.1 General

You can zoom an image by using the camera's digital zoom function. You can do this on live images and on saved images in edit mode.

The digital zoom factor is displayed at the top of the screen.



16.8.2 Procedure

Follow this procedure:

1. To digitally zoom an image, do the following:
 - Zoom in: Touch the screen with two fingers and spread the fingers apart.
 - Zoom out: Touch the screen with two fingers and pinch the fingers together.

16.9 Deleting images

You can delete image files from the memory card. For more information, see sections 17.8 *Deleting an image or video file*, page 61, 17.9 *Deleting multiple files*, page 61, and 17.10 *Deleting all files*, page 62.

16.10 Resetting the image counter

16.10.1 General

You can reset the numbering of the image filenames.

Note To prevent image files being overwritten, the new counter value will be based on the highest existing filename number in the image archive.

16.10.2 Procedure

Follow this procedure:

1. Push the joystick to display the menu system.
2. Select  (*Settings*) and push the joystick. This displays the *Settings* menu.
3. Use the joystick to select *Device settings* > *Reset options* > *Reset image counter...*
4. Push the joystick. This displays a dialog box.
5. To reset the counter, select *Reset* and push the joystick.

17.1 General

When you save an image or video clip, the camera stores the image/video file in the image archive on the memory card. You can open an image in the image archive and, for example, select another image mode, apply color alarms, and add measurement tools. You can also open and play saved video clips.

In the camera, the image archive is called *Gallery*. The *Gallery* can include one or several folders. New images and video clips will be saved to the active folder, at the top of the *Gallery*. You can create new folders, rename a folder, change the active folder, move files between the folders, and delete folders.

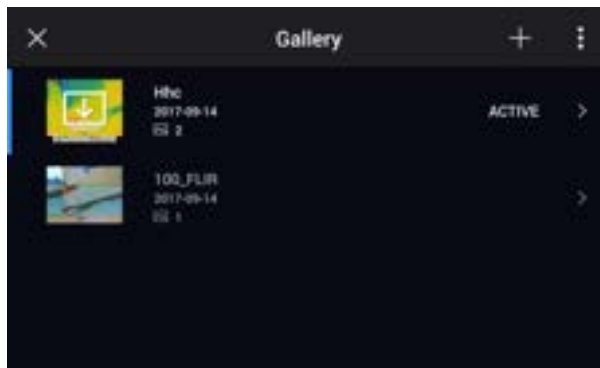



17.2 Opening image and video files

Follow this procedure:

1. Push the Image archive button . This displays the *Gallery* with one or more folders.
2. Select a folder and push the joystick.
3. Select the image or video clip you want to view and push the joystick.
4. To view the previous/next image or video clip, move the joystick left/right.
5. To return to the folder overview, push the back button .
6. To return to the *Gallery*, push the back button  again.

17.3 Creating a new folder



Follow this procedure:

1. Push the image archive button . This displays the *Gallery*.
2. On the top toolbar, select the  icon and push the joystick.
3. A soft keyboard is displayed, where you can enter the name of the folder by touching the screen.
4. When completed, touch *Done* on the soft keyboard.
5. The new folder automatically becomes the active folder and appears at the top of the *Gallery*.

17.4 Renaming a folder

You can change the name of the folders in the archive. The active folder cannot be renamed.

Follow this procedure:

1. Push the image archive button . This displays the *Gallery*.
2. On the top toolbar, select the  icon and push the joystick.
3. Select the folder to rename and push the joystick.
4. On the right toolbar, select the  icon and push the joystick.
5. A soft keyboard is displayed, where you can enter the new name of the folder by touching the screen.
6. When completed, touch *Done* on the soft keyboard.



17.5 Changing the active folder

17.5.1 General

New images and video clips are saved to the active folder.



17.5.2 Procedure

Follow this procedure:

1. Push the image archive button . This displays the *Gallery*.
2. On the top toolbar, select the  icon and push the joystick.
3. Select the folder that new images and video clips should be saved to and push the joystick. This marks the selected folder with a tick.
4. On the right toolbar, select the  icon and push the joystick.
5. The selected folder is moved to the top of the *Gallery*.

17.6 Moving files between folders

Follow this procedure:

1. Push the image archive button . This displays the *Gallery*.
2. Select a folder and push the joystick.
3. On the top toolbar, select the  icon and push the joystick.
4. Use the joystick to select the image and video items you want to move. You can also select the items by touching the screen. Selected items are marked with a tick.

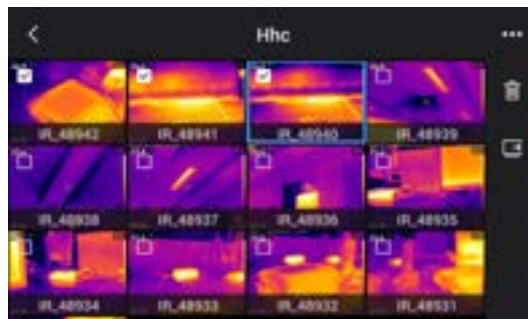



5. On the right toolbar, select the  icon and push the joystick.
6. Select the destination folder for the selected items and push the joystick.

17.7 Deleting a folder

You can delete a folder in the archive. The active folder cannot be deleted.

Follow this procedure:

1. Push the image archive button . This displays the *Gallery*.
2. On the top toolbar, select the  icon and push the joystick.
3. Select the folder to delete and push the joystick.
4. On the right toolbar, select the  icon and push the joystick. This displays a dialog box.
5. To delete the folder, select *Delete* and push the joystick.

17.8 Deleting an image or video file



17.8.1 General

You can delete an image or video file from the image archive.

Note When deleting an image file, both images in the image file (thermal and visual) will be deleted.

17.8.2 Procedure

Follow this procedure:

1. Push the image archive button . This displays the *Gallery*.
2. Select a folder and push the joystick.
3. Select the image or video clip you want to delete and push the joystick.
4. Push the joystick to display the top toolbar.
5. On the top toolbar, select the  icon and push the joystick.
6. On the right toolbar, select the  icon and push the joystick. This displays a dialog box.
7. To delete the image, select *Delete* and push the joystick.



17.9 Deleting multiple files

17.9.1 General

You can delete multiple image and video files from the image archive.

17.9.2 Procedure

Follow this procedure:

1. Push the image archive button . This displays the *Gallery*.
2. Select a folder and push the joystick.
3. On the top toolbar, select the  icon and push the joystick.

- Use the joystick to select the image and video items you want to delete. You can also select the items by touching the screen. Selected items are marked with a tick.

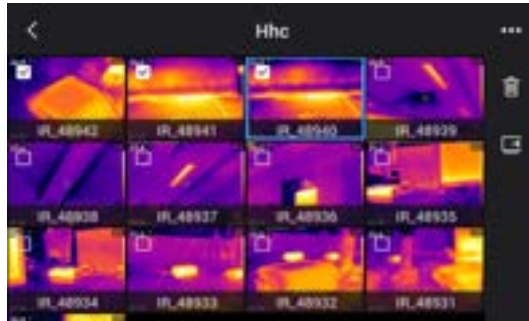

- On the right toolbar, select the  icon and push the joystick. This displays a dialog box.
- To delete the selected items, select *Delete* and push the joystick.

17.10 Deleting all files

17.10.1 General

You can delete all image and video files from the memory card.

17.10.2 Procedure

Follow this procedure:

- Push the joystick to display the menu system.
- Select  (*Settings*) and push the joystick. This displays the *Settings* menu.
- Use the joystick to select *Save options & storage > Delete all saved files...*
- Push the joystick. This displays a dialog box.
- To permanently delete all saved files, select *Delete* and push the joystick.

18.1 General

A good image depends on several different functions and settings, although some functions and settings affect the image more than others.

These are the functions and settings that you need to experiment with:

- Adjusting the infrared camera focus.
- Adjusting the infrared image (automatically or manually).
- Selecting a suitable temperature range.
- Selecting a suitable color palette.
- Changing the measurement parameters.
- Performing a non-uniformity correction (NUC).

The following sections explain how to work with these functions and settings.

In some situations, you may also want to hide the overlay graphics for a better view.

18.2 Adjusting the infrared camera focus

It is very important to adjust the focus correctly. Incorrect focus adjustment affects how the image modes work. It also affects the temperature measurement.

18.2.1 Manual focus

You can adjust the focus manually by rotating the focus ring. For more information, see section 15.6 *Adjusting the infrared camera focus manually*, page 39.

18.2.2 Autofocus

You can autofocus the infrared camera by the press of a button:

- The camera can be configured to autofocus when you push the Save button half-way down. To enable the autofocus function of the Save button, select  (Settings) > Save options & storage > Save button half-press = Autofocus.
- You can assign the autofocus function to the programmable button **P** or **P₂**. For more information, see section 15.11 *Assigning functions to the programmable buttons*, page 42.

The infrared camera can also be set up to perform continuous autofocusing. For more information, see section 15.8 *Continuous autofocus*, page 40.

18.3 Adjusting the infrared image

18.3.1 General

An infrared image can be adjusted automatically or manually.

In automatic mode, the camera continuously adjusts the level and span for the best image presentation. The colors are distributed based on the thermal content of the image (histogram color distribution). The temperature scale to the right of the screen shows the upper and lower temperatures of the current span.

In manual mode, you can adjust the temperature scale to values close to the temperature of a specific object in the image. This will make it possible to detect anomalies and smaller temperature differences in the part of the image of interest. In manual mode, the colors are distributed evenly from the lowest to the highest temperature (linear color distribution).

In manual mode, you can adjust the image by touching the screen or by using the joystick. For more information, see sections 18.3.4 *Manual adjustment by touching the screen*, page 65 and 18.3.5 *Manual adjustment by using the joystick*, page 66.

- In live mode, push the button  to switch between automatic and manual image adjustment modes.
- In preview/edit mode, manual image adjustment mode is active.

Note You can also assign image adjustment functions to one of the programmable buttons. For more information, see section 15.11 *Assigning functions to the programmable buttons*, page 42.

- *Switch between auto and manual*: Allows you to switch between automatic and manual image adjustment modes.
- *Auto adjust the manual temperature scale*: Allows you to perform an automatic adjustment of the image while remaining in manual image adjustment mode.

18.3.2 Example 1

Here are two infrared images of a building. In the left image, which is auto-adjusted, the large temperature span between the clear sky and the heated building makes a correct analysis difficult. You can analyze the building in more detail if you change the temperature scale to values close to the temperature of the building.

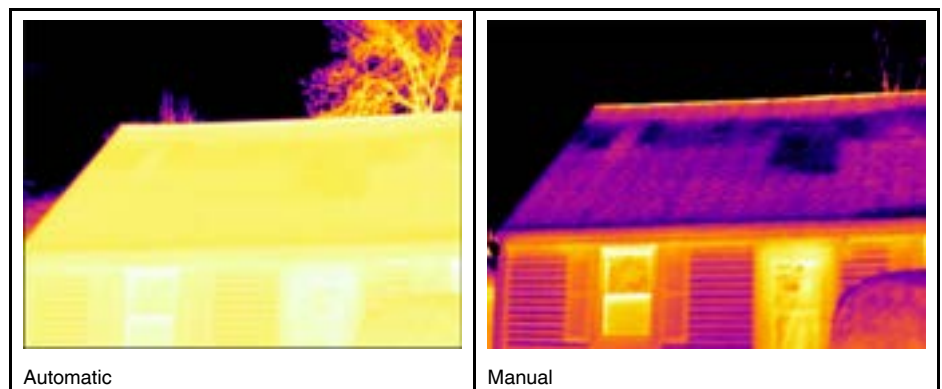

18.3.3 Example 2

Here are two infrared images of an isolator in a power line. To make it easier to analyze the temperature variations in the isolator, the temperature scale in the right image has been changed to values close to the temperature of the isolator.

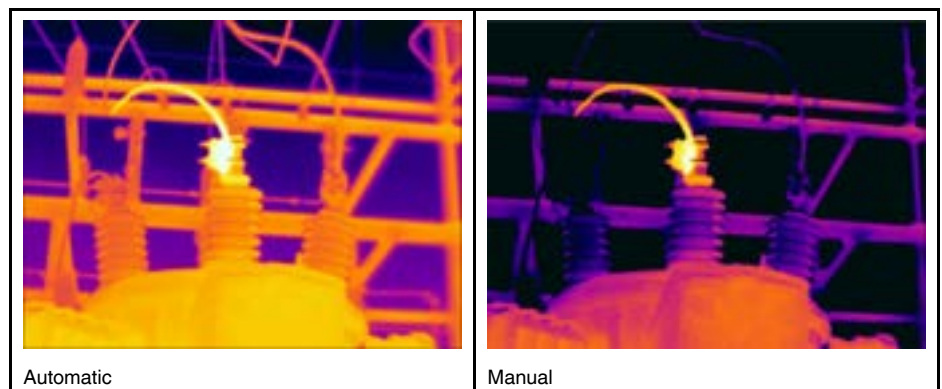

18.3.4 Manual adjustment by touching the screen

18.3.4.1 General

The touch functionality for manual image adjustments is enabled/disabled by a setting.

Select  (Settings) > Device settings > User interface options > Manual adjustment using touch > On/Off.

When manual image adjustment mode is active, an adjustment wheel is displayed to the right of the temperature scale. (Applicable when the manual adjustment by touch functionality is enabled.)

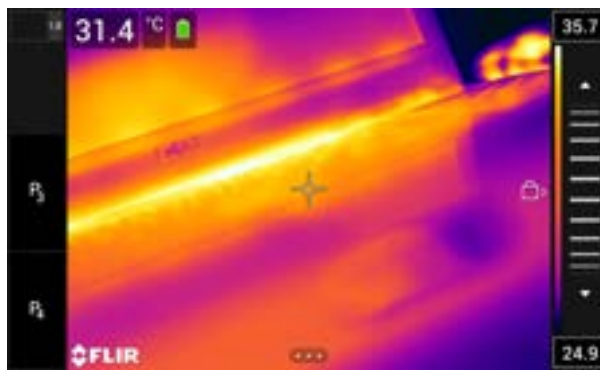



Figure 18.1 Manual adjustment mode active

18.3.4.2 Procedure

18.3.4.2.1 Procedure

Follow this procedure:

1. In live mode, push the button  to enter manual adjustment mode.
2. To simultaneously change the temperature scale minimum and maximum limits, place your finger on the screen and move it up/down.
3. To change the minimum limit or the maximum limit, do the following:
 - Touch the maximum or minimum temperature that you want to change.
 - Place your finger on the screen and move it up/down to change the value of the highlighted temperature.

18.3.4.3 Auto-adjusting the image in manual mode

In manual image adjustment mode, you can auto-adjust the image by touching the screen. The image will be auto-adjusted based on the thermal content of the area around the touched point. The top and bottom levels in the temperature scale will be set to the maximum and minimum temperatures in that area. By using the color information only for the relevant temperatures, you will get more details in your area of interest.

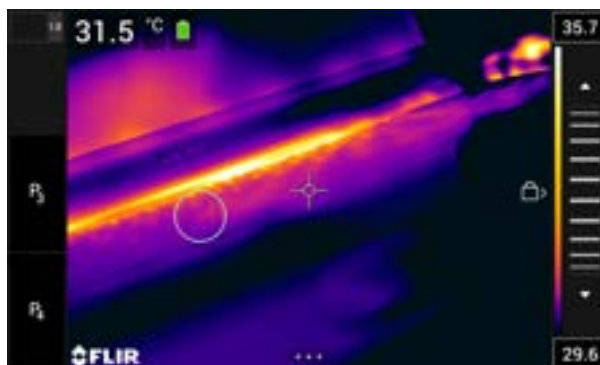

18.3.4.4 Locking the touch screen

When you have adjusted the image to levels that allow you to study your area of interest, you can lock the touch screen to prevent further unintentional adjustments.

To lock the screen, touch the  icon to the left of the temperature scale.

To unlock the screen, touch the  icon to the left of the temperature scale.

Note If you switch to automatic image adjustment mode, the screen automatically unlocks and your manual adjustments are lost.

18.3.5 Manual adjustment by using the joystick

18.3.5.1 Manual adjustment modes

There are two different settings for the manual adjustment mode (applicable for the joystick only):



- *Level, Span*: With this setting, you can manually adjust the level and span by using the joystick.
- *Level, Max, Min*: With this setting, you can manually adjust the level by using the joystick. You can also change the upper and lower temperatures individually.

Select the type of manual image adjustment mode under  (*Settings*) > *Device settings* > *User interface options* > *Manual adjustment mode*.

18.3.5.2 Manual adjustment in Level, Span mode

Note This procedure assumes that you have configured the camera for manual image adjustments in *Level, Span* mode. Select *Settings* > *Device settings* > *User interface options* > *Manual adjustment mode = Level, Span*.



Follow this procedure:

1. In live mode, push the button  to enter manual adjustment mode.
2. Move the joystick up/down to increase/decrease the level.
3. Move the joystick left/right to increase/decrease the span.
4. (Optional step.) In preview/edit mode, push the button  to perform a one-shot auto-adjust sequence.

18.3.6 Manual adjustment in Level, Max, Min mode

Note This procedure assumes that you have configured the camera for manual image adjustments in *Level, Max, Min* mode. Select *Settings* > *Device settings* > *User interface options* > *Manual adjustment mode = Level, Max, Min*.

Follow this procedure:

1. In live mode, push the button  to enter manual adjustment mode.
2. To simultaneously change the temperature scale minimum and maximum limits, move the joystick up/down.
3. To change the minimum limit or the maximum limit, do the following:
 - Move the joystick left/right to select (highlight) the maximum or minimum temperature.
 - Move the joystick up/down to change the value of the highlighted temperature.
4. (Optional step.) In preview/edit mode, push the button  to perform a one-shot auto-adjust sequence.

18.4 Changing the temperature range

18.4.1 General

The camera is calibrated for different temperature ranges. Available temperature range options are dependent on the camera model.

For accurate temperature measurements, you must change the *Camera temperature range* setting to suit the expected temperature of the object you are inspecting.

Note For more information, see section 40 *About calibration*, page 255.

18.4.2 Procedure

Follow this procedure:

1. Push the joystick to display the menu system.
2. Select  (*Settings*) and push the joystick. This displays the *Settings* menu.
3. Select *Camera temperature range* and push the joystick. This displays a dialog box.
4. Select the appropriate temperature range and push the joystick.









Note You can also assign the function *Switch temperature range* to one of the programmable buttons. For more information, see section 15.11 *Assigning functions to the programmable buttons*, page 42.

18.5 Changing the color palette

18.5.1 General

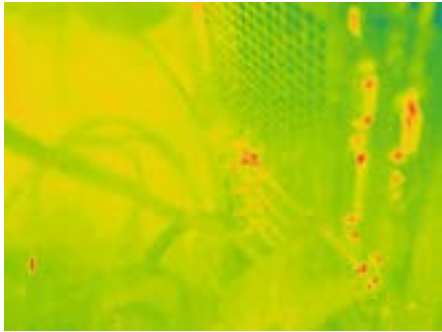
You can change the color palette that the camera uses to display different temperatures. A different palette can make it easier to analyze an image.

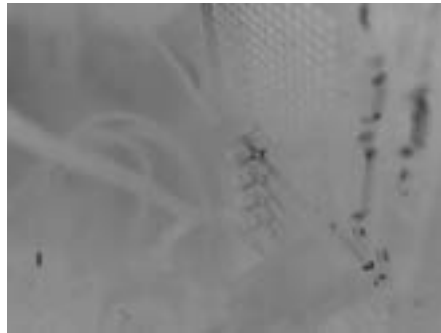
This table explains the different types of color palettes.

	
Iron	Arctic
	
Rainbow	Rainbow high contrast
	
White hot	Black hot
	
Lava	

18.5.2 Procedure

Follow this procedure:

1. Push the joystick to display the menu system.

-
2. Select  (*Color*) and push the joystick. This displays a submenu.
 3. Use the joystick to select a different palette.
 4. Push the joystick to confirm and exit the menu mode.

18.6 Changing the measurement parameters

For accurate measurements, it is important to set the measurement parameters:

- *External IR window compensation.*
- *Object distance.*
- *Atmospheric temperature.*
- *Relative humidity.*
- *Reflected temperature.*
- *Emissivity.*

You can set the measurement parameters globally. You can also change the *Emissivity*, *Reflected temperature*, and *Object distance* parameters locally for a measurement tool.

For more information, see section 20.5 *Changing the measurement parameters*, page 76.

18.7 Performing a non-uniformity correction (NUC)

18.7.1 General

When the thermal camera displays *Calibrating...* it is performing what in thermography is called a "non-uniformity correction" (NUC). An NUC is *an image correction carried out by the camera software to compensate for different sensitivities of detector elements and other optical and geometrical disturbances*³. For more information, see section 40 *About calibration*, page 255.

An NUC is performed automatically, for example at start-up, when changing a measurement range, or when the environment temperature changes.

You can also perform an NUC manually. This is useful when you have to perform a critical measurement with as little image disturbance as possible. You may, for example, want to perform a manual calibration just before you start recording a video sequence.

18.7.2 Performing an NUC manually

18.7.2.1 Procedure

Follow this procedure:

1. To perform a manual NUC, push and hold down the image archive button  for more than 2 seconds.

Note You can also assign the function *Calibrate* to one of the programmable buttons. For more information, see section 15.11 *Assigning functions to the programmable buttons*, page 42.

18.8 Hiding all overlay

18.8.1 General

The camera overlay consists of overlay graphics and image overlay information. The overlay graphics include items such as measurement tool symbols, result tables, and

3. Definition from the European standard EN 16714-3:2016, Non-destructive Testing—Thermographic Testing—Part 3: Terms and Definitions.

status icons. The image overlay information, which you activate on the *Settings* menu, provides additional information such as the date, emissivity, and atmospheric temperature. For more information, see section 13.5 *Image overlay information*, page 34.

You can choose to hide all camera overlay by the press of a programmable button.

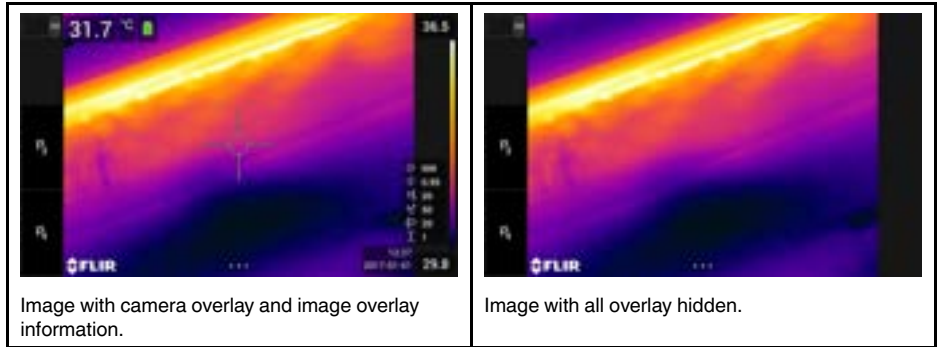

18.8.2 Procedure

Follow this procedure:

1. Push and hold a programmable button. This displays the *Programmable button* menu.
2. Move the joystick up/down to select the function *Hide image overlay graphics*.
3. Push the joystick to confirm and exit the menu mode.

19.1 General

The camera can capture both thermal and visual images at the same time. By choosing the image mode, you select which type of image to display on the screen.

The camera supports the following image modes:





- *Thermal*: An infrared image is displayed.
- *Thermal MSX* (Multi Spectral Dynamic Imaging): The camera displays an infrared image where the edges of the objects are enhanced with visual image details.
- *Picture in picture*: An infrared image frame is displayed on top of the visual image.
- *Digital camera*: The visual image captured by the digital camera is displayed.

Note

- For the *Thermal MSX*, *Thermal*, and *Picture in picture* image modes, all thermal and visual information is stored when an image is saved. This means that you can edit the image later, in the image archive, or in FLIR Tools/Tools+, FLIR Report Studio, or in FLIR ResearchIR Max, and select any of the image modes.
- For the *Digital camera* image mode, a digital image with full resolution (5 MP) is stored when an image is saved. However, no thermal information is stored.
- You can choose to turn off the digital camera. This can, for example, be required in restricted areas and in confidential (e.g., doctor/patient) situations. Select  (*Settings*) > *Save options & storage* > *Digital camera = Off*. When the digital camera is off, only the image mode *Thermal* is enabled.
- The *Thermal MSX*, *Thermal*, and *Picture in picture* image modes only work correctly for calibrated lenses. The lens that ships with the camera is factory calibrated. To calibrate a new lens, you must send the camera and the lens to your local service department.

19.2 Image examples

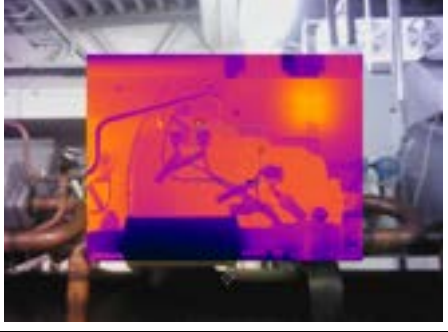
This table explains the different types of image modes.





Image mode	Image
<i>Thermal</i>	
<i>Thermal MSX</i>	
<i>Picture in picture</i>	
<i>Digital camera</i>	

19.3 Selecting an image mode

Follow this procedure:

1. Push the joystick to display the menu system.
2. Select  (*Image mode*) and push the joystick. This displays a submenu.

3. Use the joystick to select one of the following:

-  (Thermal MSX).
-  (Thermal).
-  (Picture in picture).
-  (Digital camera).

Note

- If the *.csq video format is selected (*Settings > Save options & storage > Video compression*) and the recording mode *Video* is selected, it will only be possible to select the image mode *Thermal*.
- If the digital camera is disabled (*Settings > Save options & storage > Digital camera = Off*), it will only be possible to select the image mode *Thermal*.

4. Push the joystick confirm and exit the menu mode.

5. If *Picture in picture* mode is selected, you can at this point move and resize the infrared image frame using the touch screen.





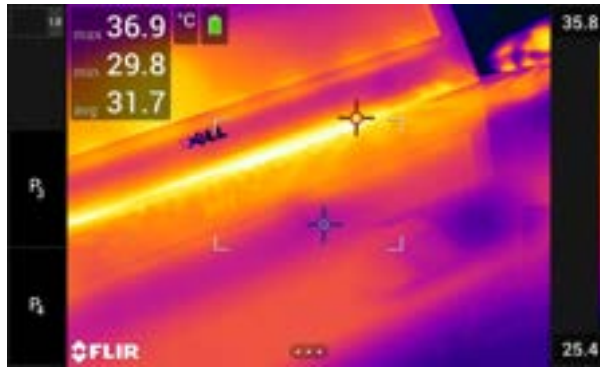

20.1 General

To measure a temperature, you can use one or more measurement tools, e.g., a spot-meter or a box.



20.2 Adding/removing measurement tools

Follow this procedure:

1. Push the joystick to display the menu system.
2. Select  (*Measurement*) and push the joystick. This displays a submenu.
3. Use the joystick to select one of the following:
 - Select  (*No measurements*) to remove all tools.
 - Select  (*Center spot*) to add a center spot.
 - Select  (*Hot spot*) to add a hot spot detection within a box area.
 - Select  (*Cold spot*) to add a cold spot detection within a box area.
 - Select  (*User preset 1*) to add user preset 1. (Not available in all camera models.)
 - Select  (*User preset 2*) to add user preset 2. (Not available in all camera models.)
4. Push the joystick to confirm and exit the menu mode.



20.3 Editing user presets









20.3.1 General

A user preset is a measurement tool, or a group of measurement tools, with predefined characteristics.

20.3.2 Procedure

Follow this procedure:

1. Push the joystick to display the menu system.
2. Select  (*Measurement*) and push the joystick. This displays a submenu.
3. Use the joystick to select  (*User preset 1*) or  (*User preset 2*).

-
4. Push and hold the joystick. This displays the *Edit user preset* menu.
 5. Select  (*Add measurement*) and push the joystick. This displays a submenu.
 6. Use the joystick to select one of the following:
 - Select  (*Add spot*) to add a spot.
 - Select  (*Add box*) to add a box.
 - Select  (*Add circle*) to add a circle.
 - Select  (*Add line*) to add a line.
 - Select  (*Add delta*) to set up a differential calculation.
 7. Push the joystick. This displays the measurement tool on the screen.
 8. Push the joystick. This displays a context menu, where you can select one or more of the following actions (depending on the type of tool):
 - Remove the tool.
 - Resize, move, center, and rotate the tool.
 - Set alarms.
 - Display maximum, minimum, and average values.
 - Set local parameters.
 - When completed, select  (*Done*) and push the joystick.
 9. When all measurement tools have been added, select  (*Save as user preset*).
 10. Push the joystick to confirm and exit the menu mode.

20.4 Moving and resizing a measurement tool

20.4.1 General

You can move and resize a measurement tool.

Note When you select another measurement tool, any changes of position and size of the current tool will be lost. If you wish to keep the position and size settings, use the user preset feature, see section 20.3 *Editing user presets*, page 74.



20.4.2 Moving a spot

Note You can also move the spot by touching the screen.

Follow this procedure:

1. To select the measurement tool, touch the tool on the screen. The tool is now displayed with one or more handles.



2. Push the joystick—or touch and hold the tool. This displays a context menu.
3. To move the spot, do the following:
 - 3.1. Select  (*Move spot*) and push the joystick.
 - 3.2. Move the joystick up/down and left/right to move the spot.
4. To center the spot, select  *Center spot* and push the joystick.
5. When completed, push the joystick and select  (*Done*).
6. Push the joystick to confirm and exit the menu mode.







20.4.3 Moving and resizing a box, circle, or line tool

Note You can also move and resize the measurement tool by touching the screen.

Follow this procedure:

1. To select the measurement tool, touch the tool on the screen. The tool is now displayed with one or more handles.



2. Push the joystick—or touch and hold the tool. This displays a context menu.
3. Select  (*Move/resize*) and push the joystick. This displays a submenu.
4. Use the joystick to select one of the following:
 - Select  (*Resize*) to change the size of the tool.
 - Select  (*Move*) to move the tool.
 - Select (depending on the tool)  (*Center box/circle*) to center the box or circle tool or  *Rotate & center line* or to rotate and center the line tool.
5. Move the joystick up/down and left/right to resize or move the tool.
6. When completed, push the joystick and select  (*Done*).
7. Push the joystick to confirm and exit the menu mode.

20.5 Changing the measurement parameters

20.5.1 General

For accurate measurements, it is important to set the measurement parameters.

Note During normal operation there is typically no need to change the default measurement parameters, see section 20.5.3 *Recommended values*, page 77.

20.5.2 Types of parameters

The camera can use these measurement parameters:

- *External IR window compensation*, i.e., the temperature of any protective windows, external lenses (e.g., the close-up lens), etc., that are set up between the camera and the object of interest. If no protective window, protective shield, or external lens is used, this value is irrelevant and should be left inactive.
- *Object distance*, i.e., the distance between the camera and the object of interest.
- *Atmospheric temperature*, i.e., the temperature of the air between the camera and the object of interest.
- *Relative humidity*, i.e., the relative humidity of the air between the camera and the object of interest.
- *Reflected temperature*, which is used when compensating for the radiation from the surroundings reflected by the object into the camera. This property of the object is called “reflectivity.”
- *Emissivity*, i.e., how much radiation an object emits, compared with the radiation of a theoretical reference object at the same temperature (called a “blackbody”). The opposite of emissivity is reflectivity. The emissivity determines how much of the radiation originates from the object as opposed to being reflected by it.

Note There is an *Emissivity mode* setting, which you can use to enter the emissivity by material instead of by value. Select  (*Settings*) > *Device settings* > *User interface options* > *Emissivity mode* > *Select from materials table*.

Emissivity is the most important measurement parameter to set correctly. If the *Emissivity* is set to a low value, the *Reflected temperature* also becomes important. The parameters *Object distance*, *Atmospheric temperature*, and *Relative humidity* are relevant for longer distances. The *External IR window compensation* must be activated if a protective window or external lens is used.

20.5.3 Recommended values

If you are unsure about the values, the following are recommended:

Object distance	1.0 m (3.3 ft.)
Atmospheric temperature	20°C (69°F)
Relative humidity	50%
Reflected temperature	20°C (69°F)
Emissivity	0.95

20.5.4 Procedure







You can set the measurement parameters globally. You can also change the *Emissivity*, *Reflected temperature*, and *Object distance* parameters locally for a measurement tool.

Local parameters are normally only effective for a fixed setup, where each measurement tool is set for a specific object of interest. For a general handheld application, the global parameters are usually sufficient.

Note *Emissivity* and *Reflected temperature* are the two most important measurement parameters to set correctly in the camera.

20.5.4.1 Setting global parameters

Follow this procedure:

1. Push the joystick to display the menu system.
2. Select  (*Measurement parameters*) and push the joystick. This displays a submenu.
3. Use the joystick to select one or more of the global measurement parameters:
 -  (*External IR window compensation*).
 -  (*Object distance*).
 -  (*Atmospheric temperature*).
 -  (*Relative humidity*).
 -  (*Reflected temperature*).
 -  (*Emissivity*).
4. Push the joystick to display a dialog box.
5. Use the joystick to change the parameter.
6. Push the joystick to confirm and exit the menu mode.





20.5.4.2 Changing local parameters

You can change the local parameters for a measurement tool.

A *P* next to the measurement tool on the screen indicates that local parameters have been activated for the tool.



Follow this procedure:

1. To select the measurement tool, touch the tool on the screen. The tool is now displayed with one or more handles.
2. Push the joystick—or touch and hold the tool. This displays a context menu.
3. Select  (*Use local parameters*).
4. Push the joystick.  (icon with unfilled indicator) is displayed.
5. Push the joystick to activate the use of local parameters.  (icon with filled indicator) is displayed together with a submenu.
6. Use the joystick to select one or more of the local measurement parameters.
7. Push the joystick to display a dialog box.
8. Use the joystick to change the parameter.
9. Push the joystick. This closes the dialog box.
10. When completed, push the joystick and select  (*Done*).
11. Push the joystick to confirm and exit the menu mode.

Note When you select another measurement tool, the local parameters are reset. If you wish to keep the local parameter settings, use the user preset feature, see section 20.3 *Editing user presets*, page 74.

20.5.5 Related topics

For in-depth information about parameters, and how to correctly set the emissivity and reflected apparent temperature, see section 39 *Thermographic measurement techniques*, page 250.

20.6 Displaying values in the result table





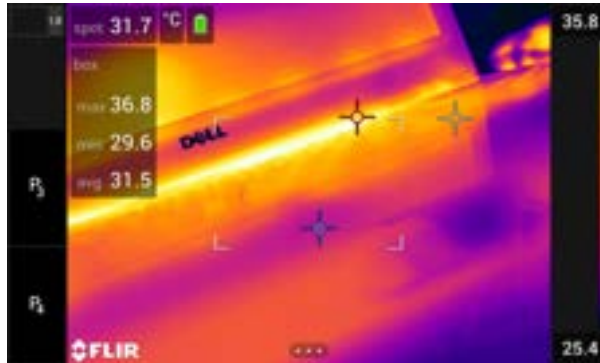



20.6.1 General

For the box, circle, and line tools, you can set the camera to display the maximum, minimum, and average values in the result table.



20.6.2 Procedure

Follow this procedure:

1. To select the measurement tool, touch the tool on the screen. The tool is now displayed with one or more handles.
2. Push the joystick—or touch and hold the tool. This displays a context menu.
3. Use the joystick to select  (*Max/Min/Avg*).
4. Push the joystick. This displays a submenu.
5. Use the joystick to select one or more of the following:
 - Select  (*Max*) to display the maximum value.
 - Select  (*Min*) to display the minimum value.
 - Select  (*Avg*) to display the average value.
 - Select  (*Max & min markers*) to display the maximum and minimum markers (the hot/cold spots).
6. Push the joystick to toggle the function between inactive and active:
 - When the icon with the unfilled indicator  is displayed, the function is inactive.
 - When the icon with the filled indicator  is displayed, the function is active.
7. When completed, move the joystick down to close the submenu.
8. Select  (*Done*) and push the joystick.

20.7 Displaying a graph

20.7.1 General

For the line tool, you can set the camera to display a graph.





20.7.2 Procedure

Note

- You can display a graph when previewing an image, when defining user presets, or when editing an image in the archive.

Follow this procedure:

1. To select the measurement tool, touch the tool on the screen. The tool is now displayed with one or more handles.
2. Push the joystick—or touch and hold the tool. This displays a context menu.
3. Use the joystick to select  (*Graph/Max/Min/Avg*).

-
4. Push the joystick. This displays a submenu.
 5. Select  (*Graph*).
 6. Push the joystick to toggle the function between inactive and active:
 - When the icon with the unfilled indicator  is displayed, the function is inactive.
 - When the icon with the filled indicator  is displayed, the function is active.
 7. When completed, move the joystick down to close the submenu.
 8. Select  (*Done*) and push the joystick.

20.8 Creating and setting up a difference calculation

20.8.1 General

A difference calculation gives the difference between the values of two known measurement results.





20.8.2 Procedure

Note

- You can set up a difference calculation when previewing an image, when defining user presets, or when editing an image in the archive.
- This procedure assumes that you have previously laid out at least one measurement tool on the screen.

20.8.2.1 Procedure

Follow this procedure:

1. To set up a difference calculation, do the following:
 - If you are defining user presets, select  (*Add measurement*) and then select  (*Add delta*).
 - If you are editing an image in the archive, select  (*Measurement*) and then select  (*Add delta*).
2. Push the joystick. This displays a dialog box where you can select the measurement tools that you want to use in the difference calculation. You can also select a fixed-temperature reference.
3. Push the joystick. The result of the difference calculation is now displayed on the screen.

20.9 Setting a measurement alarm

20.9.1 General

You can make the camera trigger an alarm when certain measurement conditions are met.

20.9.2 Types of alarm



You can choose between the following alarm types:

- *Above*: Triggers an alarm when the temperature is above the preset alarm temperature.

- *Below*: Triggers an alarm when the temperature is below the preset alarm temperature.

20.9.3 Alarm signals

When an alarm is set, the symbol  is displayed in the result table.

When an alarm is triggered, the value in the result table is displayed in red (above alarm) or blue (below alarm) and the symbol  (above alarm) or  (below alarm) is blinking. You can also set an audible alarm (there will be a “beep” when the alarm is triggered).

20.9.4 Procedure

There are different procedures for setting up an alarm for a spot, for a box, circle, or line, and for a difference calculation.

20.9.4.1 Setting up an alarm for a spot

Follow this procedure:

1. To select the spot, touch the tool on the screen. The tool is now displayed with a frame.
2. Push the joystick—or touch and hold the tool. This displays a context menu.
3. Select  (*Set alarm on spot*) and push the joystick. This displays a dialog box.
4. In the dialog box, you can define the settings for the alarm.
 - *Alarm condition*: The condition that triggers the alarm. Applicable values are *Above*, *Below*, or *Off*.
 - *Alarm limit*: The temperature value that will be the critical condition when an alarm is triggered or not.
 - *Alarm sound*: Applicable values are *Beep* or *No sound*.

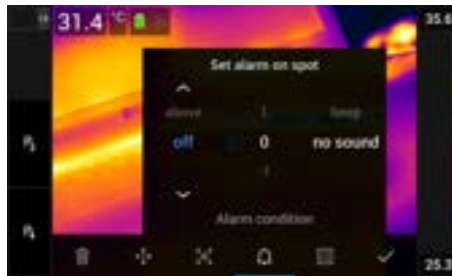

5. Push the joystick. This closes the dialog box.

20.9.4.2 Setting up an alarm for a box, circle, or line

Note This procedure assumes that you have previously set the camera to display at least one value (maximum, minimum, or average) in the result table. For more information, see section 20.6 *Displaying values in the result table*, page 78.

Follow this procedure:

1. To select the measurement tool, touch the tool on the screen. The tool is now displayed with one or more handles.
2. Push the joystick—or touch and hold the tool. This displays a context menu.
3. Select  (*Set alarm*) and push the joystick. This displays a dialog box.

4. In the dialog box, you can define the settings for the alarm.

- *Alarm condition*: The condition that triggers the alarm. Applicable values are *Above*, *Below*, or *Off*.
- *Select measurement*: Applicable settings are the values you have previously defined (*Max*, *Min*, and/or *Avg*).
- *Alarm limit*: The temperature value that will be the critical condition when an alarm is triggered or not.
- *Alarm sound*: Applicable values are *Beep* or *No sound*.

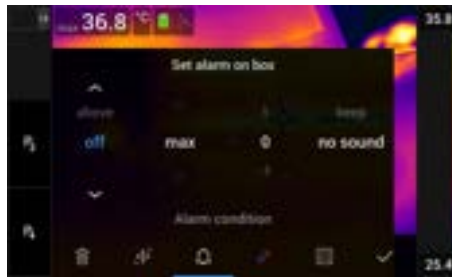

5. Push the joystick. This closes the dialog box.



20.9.4.3 Setting up an alarm for a difference calculation

Note

- You can set up an alarm for a difference calculation when defining user presets, or when editing an image in the archive.
- This procedure assumes that you have previously set up a difference calculation.

Follow this procedure:

1. To set up an alarm for a difference calculation, do the following:

- If you are defining user presets, select  (*Add measurement*).
- If you are editing an image in the archive, select  (*Measurement*).

2. Select  (*Select*) and push the joystick. This displays a dialog box.

3. Select *Delta* and push the joystick. This displays a context menu.

4. Select  (*Set alarm on delta*) and push the joystick. This displays a dialog box.

5. In the dialog box, you can define the settings for the alarm.

- *Alarm condition*: The condition that triggers the alarm. Applicable values are *Above*, *Below*, or *Off*.
- *Alarm limit*: The temperature value that will be the critical condition when an alarm is triggered or not.
- *Alarm sound*: Applicable values are *Beep* or *No sound*.

6. Push the joystick. This closes the dialog box.

Working with color alarms and isotherms

21.1 Color alarms

21.1.1 General

By using color alarms (isotherms), anomalies can easily be discovered in an infrared image. The isotherm command applies a contrasting color to all pixels with a temperature above, below, or between the set temperature levels. The camera also features isotherm types that are specific to the building trade: condensation and insulation alarms.

You can make the camera trigger the following types of color alarms:

- *Above alarm*: This will apply a contrasting color to all pixels with a temperature above the specified temperature level.
- *Below alarm*: This will apply a contrasting color to all pixels with a temperature below the specified temperature level.
- *Interval alarm*: This will apply a contrasting color to all pixels with a temperature between two specified temperature levels.
- *Condensation alarm*: Triggers when the camera detects a surface where the relative humidity exceeds a preset value.
- *Insulation alarm*: Triggers when there is an insulation deficiency in a wall.

21.1.2 Image examples



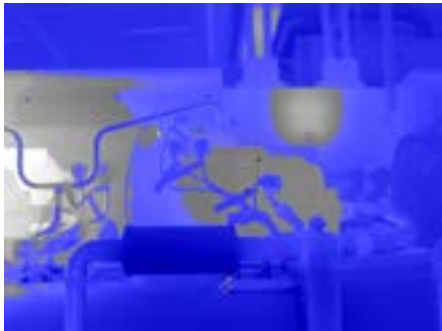

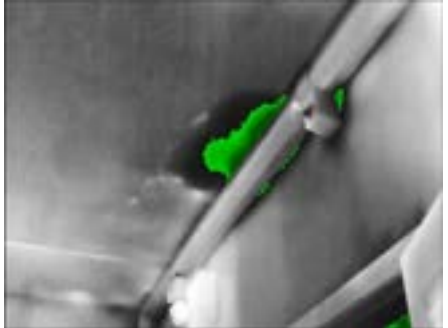
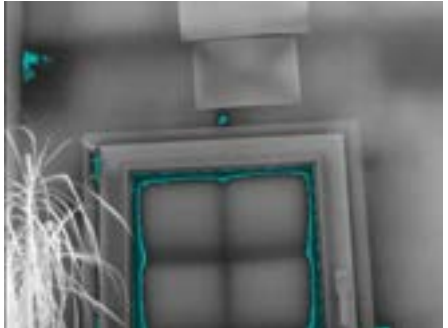
This table explains the different color alarms (isotherms).

Color alarm	Image
<i>Above alarm</i>	
<i>Below alarm</i>	

Color alarm	Image
<i>Interval alarm</i>	
<i>Condensation alarm</i>	
<i>Insulation alarm</i>	

21.1.3 Setting up above, below, and interval alarms

Follow this procedure:

1. Push the joystick to display the menu system.
2. Select  (*Color*) and push the joystick. This displays a submenu.
3. Use the joystick to select one of the following:
 -  (*Above alarm*).
 -  (*Below alarm*).
 -  (*Interval alarm*).
4. Push the joystick. The threshold temperature is displayed at the top of the screen.
5. To change the threshold temperature, do the following:
 - For the *Interval alarm*, move the joystick left/right to select the low/high-temperature value.
 - Move the joystick up/down to change the threshold temperature.

21.1.4 Building isotherms

21.1.4.1 About the *Condensation alarm*

To detect areas with potential moisture problems, you can use the *Condensation alarm*. You can set the relative humidity above which the isotherm will colorize the image.



21.1.4.2 About the *Insulation alarm*

The *Insulation alarm* can detect areas where there may be an insulation deficiency in the building. It will trigger when the insulation level (which is called the thermal index in the camera) falls below a preset value of the energy leakage through a wall.

Different building codes recommend different values for the insulation level, but typical values are 60–80% for new buildings. Refer to your national building code for recommendations.

21.1.4.3 Setting up condensation and insulation alarms

Follow this procedure:

1. Push the joystick to display the menu system.
2. Select  (*Color*) and push the joystick. This displays a submenu.
3. Use the joystick to select one of the following:
 -  (*Condensation alarm*).
 -  (*Insulation alarm*).

4. Push the joystick. This displays a dialog box where you can define the settings for the alarm.

For the *Condensation alarm*, the following parameters can be set:

- *Atmospheric temperature*: The current atmospheric temperature.
- *Relative humidity*: The current relative humidity.
- *Relative humidity limit*: The relative humidity level at which you want the alarm to be triggered. A relative humidity of 100% means that water vapor condenses from the air as liquid water (= dewpoint). A relative humidity of about 70% or above can cause mold.

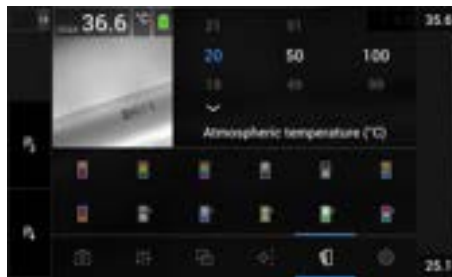

For the *Insulation alarm*, the following parameters can be set:

- *Indoor temperature*: The current indoor temperature.
- *Outdoor temperature*: The current outdoor temperature.
- *Thermal index*: The insulation level (an integer between 0 and 100).



5. Push the joystick. This closes the dialog box.

22.1 General

You can save additional information with an infrared image by using annotations. Annotations make reporting and post-processing more efficient by providing essential information about the image, e.g., conditions and information about where an image is taken.

Annotations are added to the image file, and can be viewed and edited in the image archive, and also when moving files from the camera to reporting software on the computer.

- You can set the camera to display annotation tools when an image is saved. Select



(Settings) > Save options & storage > Add annotation after saving.

- You can also add annotations to a saved image in the image archive.

Note This section describes the procedures for adding annotations to a saved image in the image archive. Adding annotations when saving an image works in a similar way.

22.2 Adding a note



22.2.1 General

You can add a text note to the image file. Using this feature, you can annotate images by entering free-form text.



22.2.2 Procedure

Follow this procedure:

- Open the image in the image archive.
- Push the joystick to display the top toolbar.
- On the top toolbar, select the  icon and push the joystick.
- On the right toolbar, select the  icon and push the joystick.
- A soft keyboard is displayed, where you can enter text by touching the screen.
- When completed, touch *Done* on the soft keyboard.

22.3 Adding a text comment table

22.3.1 General



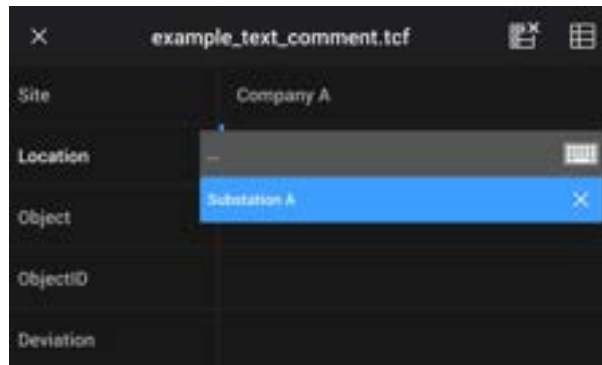

You can save a table with textual information to the image file. This feature is a very efficient way of recording information when you are inspecting a large number of similar objects. The idea behind using a table with textual information is to avoid filling out forms or inspection protocols manually.

The camera ships with an example text comment table template. You can also create your own templates. For more information, see section 22.3.3 *Creating a text comment table template*, page 88.



22.3.2 Procedure

Follow this procedure:

1. Open the image in the image archive.
2. Push the joystick to display the top toolbar.
3. On the top toolbar, select the  icon and push the joystick.
4. On the right toolbar, select the  icon and push the joystick. This displays a table.
5. (Optional step.) On the top toolbar, do one of the following:
 - To clear the content of the current table, select the  icon and push the joystick.
 - To select another table template, select the  icon and push the joystick.
6. For each row in the table, do the following:
 - Push the joystick. This displays the predefined values.
 - Move the joystick up/down to select a predefined value. Push the joystick to confirm.
 - Instead of selecting a predefined value, you can select the keyboard  icon and enter other text by touching the screen.

Note Text entered by the keyboard will be saved to the text comment table template. Next time you add a text comment table annotation, the entered text will be displayed as a predefined value.
7. When completed, select *Save & Exit* at the bottom of the table. Push the joystick to confirm.

22.3.3 Creating a text comment table template

22.3.3.1 General

You can create a text comment table template in different ways:

- Using FLIR Tools/Tools+, see section 22.3.3.2 *Creating a table template using FLIR Tools/Tools+*, page 88.
- Manually creating a text comment file (*.tcf), see section 22.3.3.3 *Manually creating a table template*, page 89.

22.3.3.2 Creating a table template using FLIR Tools/Tools+

Note If your camera uses an SD card that has been used in another camera, FLIR Tools/Tools+ cannot create proper templates for this camera. Please clear the SD card entirely before using tables templates from FLIR Tools/Tools+.

22.3.3.2.1 General

In FLIR Tools/Tools+, you can create text annotation templates on the *Templates* tab. These templates can either be transferred to the camera or used as a template during post-analysis in the program.

22.3.3.2.2 Procedure

Follow this procedure:

1. Click the *Templates* tab.
2. Click the *Add new text annotations template* toolbar button.
3. Create a name for the template.
4. Enter the desired fields and values. See the image below for examples.

Fields	Values
Company	FLIR Systems
Building	Warehouse

5. Save the template.
6. Do one of the following:
 - To use the template in the camera, connect a camera to FLIR Tools/Tools+ and transfer the template to the camera.
 - To use the template during post-analysis in FLIR Tools/Tools+, double-click an image, and then click *Import from template* under *Text annotations* in the right pane.

22.3.3.3 Manually creating a table template

22.3.3.3.1 General

A text comment file (*.tcf) is an annotation format that is proprietary to FLIR Systems. It defines a table structure that can be used to add text table annotations to FLIR images. You can create text comment files (*.tcf files) and use these files as table templates in the camera.

The camera ships with an example text comment table file: *example_text_comment.tcf*. The file is stored on the memory card in the subfolder \TextTableTemplates. You can make a copy of the example file and modify it using a text editor such as Microsoft Notepad.

When creating or modifying a text comment file, keep the following rules in mind:

1. Lines starting with “#” are regarded as comments and will be ignored.
2. Lines that start with “<” and end with “>” are labels and will appear on the left-hand side of the table.
3. Non-empty lines under a label line are regarded as values and will be displayed as options to the label above.
4. When you save the file, select UTF-8 encoding. With UTF-8 encoding, the file will support all languages currently supported by the camera.
5. The template will be updated by the camera if you add or remove values in the text table annotations dialog in the camera. This enables you to modify its content while you are working with the camera.
6. The camera will find all text table template files if:
 - They are placed on the memory card in the subfolder \TextTableTemplates.
 - They have an ASCII filename and the file extension .tcf. (ASCII characters include a–z, A–Z, 0–9, and basic punctuation, and spaces can be used. The file can contain non-ASCII text, but the filename must be ASCII.)

22.3.3.3.2 Example mark-up structure

The file format for the text comment table template is *.tcf. This code sample is an example mark-up structure of such a file, and shows how the mark-up appears in a text editor such as Notepad.

```
<Site>
Company A
Company B
<Location>
Substation A
<Object>
Engine
Vent
Vault
Door
<ObjectID>
Ala1
Alb2
Alc3
<Deviation>
Overload
Moisture
Draft
<Remedy>
Replace
Fix
No action
<Severity>
Critical
Non-critical
<Severity>
```

22.4 Adding a voice annotation

22.4.1 General





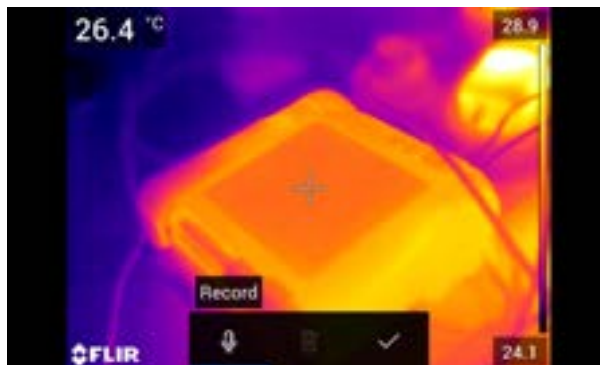

A voice annotation is an audio recording that is saved to the infrared image file. The recording can be played back in the camera, and in image analysis and reporting software from FLIR Systems.

The voice annotation is recorded using a Bluetooth headset. For information on how to pair a headset with the camera, see section 26 *Pairing Bluetooth devices*, page 97.



22.4.2 Procedure

Follow this procedure:

1. Open the image in the image archive.
2. Push the joystick to display the top toolbar.
3. On the top toolbar, select the  icon and push the joystick.
4. On the right toolbar, select the  icon and push the joystick.
5. A context menu is displayed.
6. To start a recording, select  (*Record*) and push the joystick.
7. To stop the recording, select  (*Stop*) and push the joystick.
8. To listen to the recording, select  (*Play*) and push the joystick.
9. To delete the recording, select  (*Delete*) and push the joystick.
10. When completed, select  (*Done*) and push the joystick.

22.5 Adding a sketch



22.5.1 General

You can add a freehand drawing to an infrared image.







22.5.2 Procedure

Follow this procedure:

1. Open the image in the image archive.
2. Push the joystick to display the top toolbar.
3. On the top toolbar, select the  icon and push the joystick.
4. On the right toolbar, select the  icon and push the joystick.
5. You are now in sketch mode. Draw the sketch by touching the screen.

6. (Optional step.) Push the joystick. This displays a context menu. Do one or more of the following:

- To change the color of the sketch tools, select  (*Draw*) and push the joystick. Select the color and push the joystick.
- To erase, select  (*Eraser*) and push the joystick. Erase parts of the sketch by touching the screen.
- To add an arrow, circle, or cross, select  (*Stamp sketch*) and push the joystick. Select the type of stamp and push the joystick. The stamp is displayed in the center of the screen. You can move the stamp by using the joystick or by touching the screen. When completed, push the joystick.
- To clear, select  (*Clear all*) and push the joystick.
- When the sketch is completed, select  (*Save*) and push the joystick.

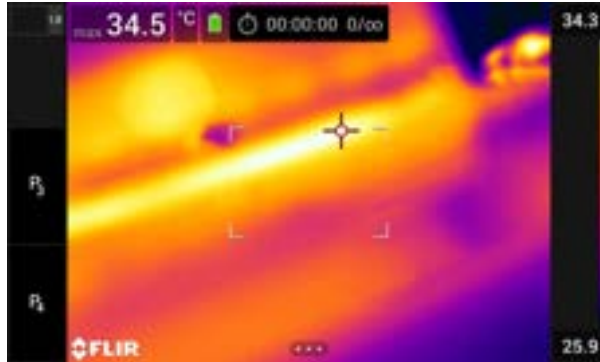

23.1 General

You can program the camera to save images periodically (time-lapse).



23.2 Procedure

Follow this procedure:

1. Push the joystick to display the menu system.
2. Select  (*Recording mode*) and push the joystick. This displays a submenu.
3. Select  (*Time-lapse*).
4. Push the joystick. This displays a dialog box where you can set the save conditions:
 - *Save interval*: Use the joystick to set the time interval between each saved image.
 - *Total number of images*: Periodic saving will stop when the set number of images have been saved.

Note If you select “∞,” the camera will keep on saving images until the memory card is full or until you manually stop the time-lapse.
5. Push the joystick. This closes the dialog box.
6. The time interval is displayed at the top of the screen.
7. To start the time-lapse (periodic saving), push the Save button.
8. To manually stop the time-lapse, push the Save button.
9. When the time-lapse is completed, an information screen is displayed. Push any button or touch the screen to return to the live image.

24.1 General

You can record and save video clips to the memory card.

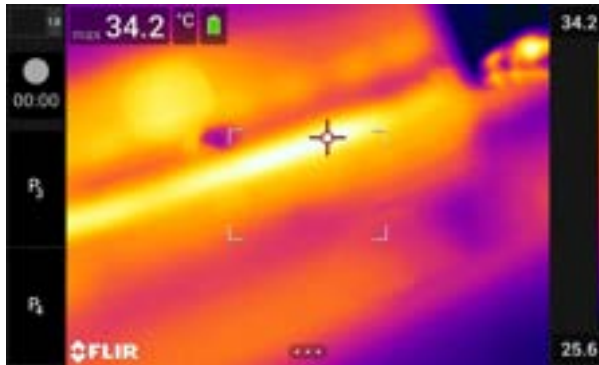



Note The camera can be configured to save video in *.mpg or *.csq format. Select (Settings) > Save options & storage > Video compression. 

- *Mpeg (*.mpg)*: Mpeg recordings cannot be edited after the file has been saved.
- *Radiometric storage (*.csq)*: A *.csq file supports full radiometry but is only supported by FLIR Systems software. The file does not include any visual image information. With this setting, only *Thermal* image mode is supported when recording video. If any other image mode is active when *Video* recording mode is selected, the camera will auto-switch to *Thermal* image mode.



24.2 Procedure

Follow this procedure:

1. Push the joystick to display the menu system.
2. Select  (*Recording mode*) and push the joystick. This displays a submenu.
3. Select  (*Video*) and push the joystick.
4. To start a recording, push the Save button fully down. A counter at the left of the screen displays the duration of the recording.
5. To stop a recording, push the Save button fully down. The recording is automatically saved to the image archive.

24.3 Playing a saved video clip

Follow this procedure:

1. Push the image archive button . This displays the *Gallery* with one or more folders.
2. Select a folder and push the joystick.
3. Select the video clip you want to play and push the joystick.
4. Push the joystick to display the top toolbar.
5. On the top toolbar, select the  icon and push the joystick.
6. To play or pause the video clip, push the joystick.

25.1 General

The screening alarm can be used, for example, at airports to detect passengers with elevated body temperatures, which may indicate the presence of a fever.

The screening alarm can also be used to detect temperature anomalies in a series of inspected objects in a similar/fixed setup.

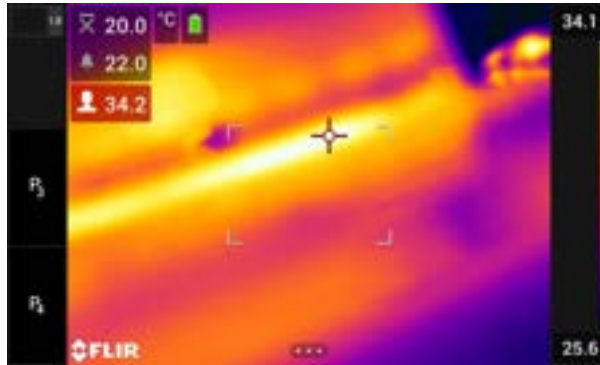



Activating the screening mode will turn on a measurement box and screening data in the result table.

 The sampled average temperature.

 The alarm temperature.



 The measured temperature.

The alarm will trigger when the measurement box measures a temperature higher than the alarm temperature. The alarm temperature is, in turn, the sum of a specified allowed deviation and a sampled average value.

	WARNING
<p>Make sure that the laser is disabled when you point the camera at the face of a person. The laser beam can cause eye irritation. Disable the laser by selecting  (<i>Settings</i>) > <i>Device settings</i> > <i>Lamp & laser</i> > <i>Disable all</i>.</p>	

25.2 Procedure

Follow this procedure:

1. Enable the screening mode by selecting  (*Settings*) > *Device settings* > *User interface options* > *Screening mode = On*.
2. Push the joystick to display the menu system.
3. Select  (*Recording mode*) and push the joystick. This displays a submenu.
4. Select  (*Screening*).
5. Push the joystick. This displays a dialog box where you can define the settings for the alarm:
 - *Allowed deviation*: The allowed deviation from the sampled average.
 - *Alarm sound*: Applicable values are *Beep* or *No sound*.
6. Push the joystick. This closes the dialog box.

7. Aim the camera toward a point of interest. The object should be within the frame of the measurement box.
8. To reset the sampled average, push and hold the programmable button **P**.
9. To sample, push the programmable button **P**.
10. Aim the camera toward more points of interest. Sample 10 times to build up a sample base by pushing the programmable button **P**.

The alarm is now set up and ready to use. Occasionally record a few samples if the alarm is used for a long time or if the conditions change.

Note

- Every time you push the programmable button **P**, a sample is saved. Make sure you aim the camera toward an object within the interesting temperature range when you push (and hold) the button.
- The algorithm has a memory of the last 10 samples. It discriminates between the highest and lowest values, and calculates an average of the remaining values.
- Do not modify the measurement setup or activate another alarm because this will deactivate the screening alarm.

26.1 General

You can use the camera with the following Bluetooth devices:

- METERLiNK devices (FLIR meters).
- Bluetooth-enabled headsets.

Before you can use a Bluetooth device with the camera, you need to pair the devices. The Bluetooth functionality is managed from the *Settings* menu. You can also enable/disable Bluetooth on the swipe-down menu. For more information, see section 13.4 *Swipe-down menu*, page 34.

26.2 Procedure

Follow this procedure:

1. Push the joystick to display the menu system.
2. Select  (*Settings*) and push the joystick. This displays the *Settings* menu.
3. Use the joystick to select *Connections > Bluetooth*.
4. If the *Bluetooth* check box is unchecked, push the joystick to enable Bluetooth.

Note You also need to ensure that the external Bluetooth device is in visible mode.

5. Select *Available devices* and push the joystick.
6. Wait until a list of available devices is displayed. This will take about 15 seconds.
7. When a Bluetooth device is found, select the device to add it, and begin the pairing procedure. The device is then ready to be used.

Note

- Only METERLiNK devices (FLIR meters) and Bluetooth-enabled headsets will appear in the list of available devices.
- You can add several devices.
- You can remove a device by selecting the device and then selecting *Unpair device*.
- After adding a METERLiNK device, such as the FLIR MR77 or FLIR DM93, the result from the meter will be visible in the result table and stored with the images. For more information, see section 28 *Fetching data from external FLIR meters*, page 99.
- After adding a Bluetooth-enabled headset, it is ready to be used for adding voice annotations. Adding a Bluetooth-enabled headset automatically disables the built-in microphone and speaker.

27.1 General

Depending on your camera configuration, you can connect the camera to a wireless local area network (WLAN) using Wi-Fi, or let the camera provide Wi-Fi access to other devices.

You can connect the camera in two different ways:

- *Most common use:* Setting up the camera as a wireless access point. This method is primarily used with other devices, e.g., an iPhone or iPad.
- *Less common use:* Connecting the camera to a wireless local area network (WLAN).

The Wi-Fi functionality is managed from the *Settings* menu. You can also enable/disable Wi-Fi on the swipe-down menu. For more information, see section 13.4 *Swipe-down menu*, page 34.

27.2 Setting up a wireless access point (most common use)

Follow this procedure:

1. Push the joystick to display the menu system.
2. Select  (*Settings*) and push the joystick. This displays the *Settings* menu.
3. Use the joystick to select *Connections > Wi-Fi*.
4. Select *Share* and push the joystick.
5. (Optional step.) To display and change the parameters, select *Share settings* and push the joystick.
 - To change the SSID, select *Network name (SSID)* and push the joystick.
 - To change the WPA2 password, select *Password* and push the joystick.

Note These parameters are set for your camera's network. They will be used by the external device to connect that device to the network.

27.3 Connecting the camera to a WLAN (less common use)

Follow this procedure:

1. Push the joystick to display the menu system.
2. Select  (*Settings*) and push the joystick. This displays the *Settings* menu.
3. Use the joystick to select *Connections > Wi-Fi*.
4. Select *Connect to network* and push the joystick.
5. To display a list of the available networks, select *Available networks* and push the joystick.
6. Select one of the available networks and push the joystick.

Note Password-protected networks are indicated with a padlock icon, and for these you will need to enter a password the first time you connect to the network. After that the camera will connect automatically to the network. To disable the automatic connection, select *Forget network*.

Note Some networks do not broadcast their existence. They appear in the list as *Untitled*. To connect to such a network, you will be prompted to enter additional parameters.

Fetching data from external FLIR meters

28.1 General

You can fetch data from some external FLIR meters that support Bluetooth and merge this data into the infrared image. When the camera is connected to a FLIR meter via Bluetooth, the measurement value from the meter is displayed in the result table of the camera. The FLIR meter value is also added to the information saved in the image file.

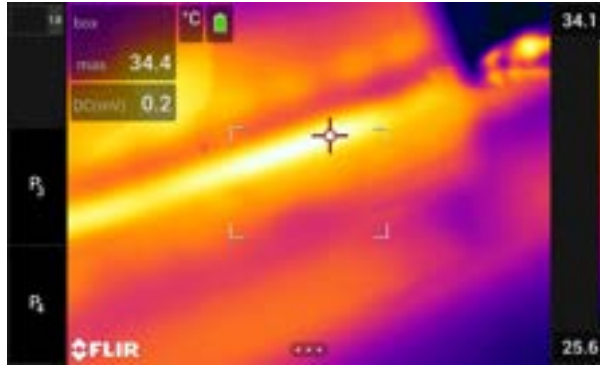

In preview mode and when editing an image in the archive, you can add more than one value from the same FLIR meter. The last added value is displayed below the previous values. The live value is displayed with a dotted outline.

If the screen display for values is full, it is still possible to add more values from the FLIR meter. Added values are then indicated by a box with a number that counts up each time a new value is added.

To find out whether a FLIR meter is supported by the camera, consult the meter documentation.

28.2 Technical support for external meters

Technical support	
Website	http://support.flir.com
E-mail	TMsupport@flir.com
Phone	855-499-3662
Repairs	repair@flir.com

28.3 Procedure

Note

- Before you can use a FLIR meter with the camera, you need to pair the devices. For more information, see section *26 Pairing Bluetooth devices*, page 97.
- To add more than one FLIR meter value when saving an image, preview mode must be enabled. Select  (Settings) > Save options and storage > Preview image before saving = On.

Follow this procedure:

1. Turn on the camera.
2. Turn on the FLIR meter.
3. On the FLIR meter, enable Bluetooth mode. Refer to the user documentation for the meter for information on how to do this.

4. On the FLIR meter, choose the quantity that you want to use (voltage, current, resistance, etc.). Refer to the user documentation for the meter for information on how to do this.

Results from the meter will now automatically be displayed in the result table in the top left corner of the infrared camera screen.

5. On the camera, in preview mode and when editing an image in the archive, you can do the following:
 - Push the programmable button **P** to add the value currently displayed by the FLIR meter.
 - Push and hold the programmable button **P** to remove all FLIR meter values from the image.

Note Any function assigned to the programmable button is temporarily disabled when in preview mode or when editing an image in the archive.

28.4 Typical moisture measurement and documentation procedure

28.4.1 General

The following procedure can form the basis for other procedures using FLIR meters and infrared cameras.

28.4.2 Procedure

Follow this procedure:

1. Use the infrared camera to identify any potential damp areas behind walls and ceilings.
2. Use the moisture meter to measure the moisture levels at various suspect locations that may have been found.
3. When an area of particular interest is located, store the moisture reading in the moisture meter's memory and identify the measurement area with a handprint or other thermal identifying marker.
4. Recall the reading from the meter memory. The moisture meter will now continuously transmit this reading to the infrared camera.
5. Use the camera to take a thermal image of the area with the identifying marker. The stored data from the moisture meter will also be saved on the image.

28.5 More information

For more information, see the user manuals that are shipped with FLIR meters.

29.1 General

You can change a variety of settings in the camera. You do this on the *Settings* menu.

The *Settings* menu includes the following:

- *Connections*.
- *Camera temperature range*.
- *Save options & storage*.
- *Device settings*.

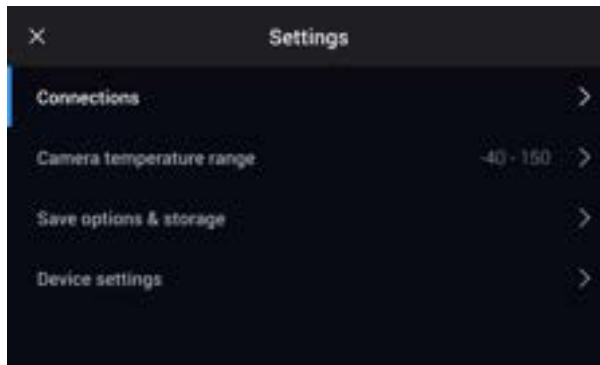

29.1.1 Connections

- *Wi-Fi*: This setting defines Wi-Fi networks. For more information, see section 27 *Configuring Wi-Fi*, page 98.
- *Bluetooth*: This setting defines Bluetooth connectivity. For more information, see section 26 *Pairing Bluetooth devices*, page 97.

29.1.2 Camera temperature range

For accurate temperature measurements, you must change the *Camera temperature range* setting to suit the expected temperature of the object you are inspecting.

Available temperature range options are dependent on the camera model. The unit (°C or °F) depends on the temperature unit setting, see section 29.1.4 *Device settings*, page 102.

29.1.3 Save options & storage

- *Save button half-press*: This setting defines the function of the Save button. Available options are:
 - *Autofocus*: Pushing the Save button half-way down will autofocus the infrared camera.
 - *None*: Pushing the Save button half-way down will have no effect. With this setting, you may want to assign the autofocus function to one of the programmable buttons.
- *Preview image before saving*: This setting defines if a preview image will be displayed before the image is saved.
- *Add annotation after saving*: This setting defines if an annotation tool will be displayed when the image has been saved. Available options are:
 - *Save*: No annotation tool will be displayed.
 - *Save & add note*: The note annotation tool will be displayed.
 - *Save & add table*: The table annotation tool will be displayed.
 - *Save & add voice annotation*: The voice annotation tool will be displayed.
 - *Save & add sketch*: The sketch annotation tool will be displayed.
 - *Save & add any annotation*: The annotation tool menu will be displayed.

-
- *Image resolution*: This setting defines the resolution of the images captured by the camera. Available options are *Normal* and *UltraMax*. For more information, see section 16.1.4 *About UltraMax*, page 54.
 - *Video compression*: This setting defines the storage format for video clips. Available options are:
 - *Mpeg (*.mpeg)*: MPEG recordings cannot be edited after the file has been saved.
 - *Radiometric storage (*.csq)*: A CSQ file supports full radiometry but is only supported by FLIR Systems software. The file does not include any visual image information. With this setting, only the image modes *Thermal* and *Macro* are supported when recording video.
 - *Photo as separate JPEG*: For the *Thermal MSX*, *Thermal*, and *Picture in picture* image modes, a visual image is always saved in the same JPEG file as the thermal image. Enabling this setting saves an extra low-resolution visual image as a separate JPEG file.
 - *Digital camera*: This setting is used to turn on/off the digital camera. Turning off the digital camera can for example be required in restricted areas and in confidential (e.g. doctor/patient) situations. When the digital camera is off, the image modes *Thermal MSX* and *Picture in picture* are disabled.
 - *File naming format*: This setting defines the naming format for new image/video files. The setting has no impact on already saved files in the archive. Available options are:
 - *DCF*: DCF (Design rule for Camera File system) is a standard that specifies the naming method of image files (and much more). With this setting, the name of a saved image/video file will be FLIRxxxx, where xxxx is an incremental counter. Example: FLIR0001.
 - *Date prefix*: A prefix will be added to the filename, including the date and the text “IR_” for images and “MOV_” for videos. Examples: IR_2015-04-22_0002 and MOV_2015-04-22_0003. The date format will follow the *Date & time format* setting, see section 29.1.4 *Device settings*, page 102.

Note With the *Date prefix* setting, the files may not automatically be detected by third-party applications.
 - *Delete all saved files...*: This displays a dialog box where you can choose to permanently delete all the saved files (images and videos) from the memory card or to cancel the delete action.

29.1.4 Device settings

- *Language, time & units*: This submenu includes settings for a number of regional parameters:
 - *Language*.
 - *Temperature unit*.
 - *Distance unit*.
 - *Time zone*.
 - *Date & time*.
 - *Date & time format*.
- *Continuous autofocus*: This setting is used to enable/disable continuous autofocus.
- *Display settings*: This submenu includes the following settings:
 - *Screen rotation*: This setting defines if the orientation of the overlay graphics will change according to how you hold the camera.

Note You can also enable/disable screen rotation on the swipe-down menu. For more information, see section 13.4 *Swipe-down menu*, page 34.
 - *Image overlay information*: This setting specifies what image information the camera will display as an overlay on the image. For more information, see section 13.5 *Image overlay information*, page 34. You can select the following information to display:
 - *Compass*.

- *Date & time.*
- *Emissivity.*
- *Reflected temperature.*
- *Distance.*
- *Relative humidity.*
- *Atmospheric temperature.*

Note This setting only specifies what information to overlay on the image. All image information is always saved to the image file and is available in the image archive.

- *Screen brightness:* The screen brightness slider is used to control the brightness of the screen.

Note You can also control the screen brightness on the swipe-down menu. For more information, see section 13.4 *Swipe-down menu*, page 34.
- *Viewfinder brightness:* This setting defines the brightness of the viewfinder. Available options are *Low*, *Medium*, and *High*.
- *HDMI:* (Applicable when an HDMI cable is connected to the camera.) This setting defines the resolution of the digital video output. The setting can be used to select display of the image only, or display of the image and the entire overlay graphics.
- *Geolocation:* This submenu includes the following settings:
 - *GPS:* This setting is used to enable/disable the GPS.
 - *Compass:* This setting is used to enable/disable the compass and to calibrate the compass. For more information, see section 15.16 *Calibrating the compass*, page 53.
- *Lamp & laser:* This submenu includes the following settings:
 - *Enable lamp & laser:* This setting is used to enable the camera lamp and the laser.
 - *Enable lamp & laser + Use lamp as flash:* This setting is used to enable the flash function. When the flash function is enabled, the camera lamp will flash when an image is saved.
 - *Disable all:* This setting is used to disable the camera lamp, laser, and flash function.
- *Auto power off:* This setting defines how soon the camera is automatically turned off. Available choices are *Off*, *5 min*, and *20 min*.
- *User interface options:* This submenu includes the following settings:
 - *Manual adjustment using touch:* This setting is used to enable/disable the touch functionality for manual image adjustments. For more information, see section 18.3 *Adjusting the infrared image*, page 63.
 - *Manual adjustment mode:* This setting specifies the type of manual image adjustment mode. Available options are *Level*, *Max*, *Min* and *Level*, *Span*. For more information, see section 18.3 *Adjusting the infrared image*, page 63.
 - *Emissivity mode:* This setting specifies how the measurement parameter emissivity will be entered. Available options are *Select values* and *Select from materials table*. For more information, see section 18.6 *Changing the measurement parameters*, page 69.
 - *Screening mode:* This setting is used to enable/disable screening mode. For more information, see section 25 *Screening alarm*, page 95.
- *Reset options:* This submenu includes the following settings:
 - *Reset default camera mode...:* This setting will affect the image mode, color palette, measurement tools, and measurement parameters. Saved images will not be affected.
 - *Reset device settings to factory default...:* This setting will affect all camera settings, including regional settings. Saved images will not be affected. The camera will be restarted and you will be prompted to set the regional settings.

- *Reset image counter...:* This setting will reset the numbering of the image file-names. To prevent image files being overwritten, the new counter value will be based on the highest existing filename number in the image archive.

Note When a reset option is selected, a dialog box is displayed with more information. You can choose to execute the reset action or to cancel.

- *Camera information:* This submenu displays information about the camera. No changes can be made.
 - *Model.*
 - *Serial number.*
 - *Part number.*
 - *Software:* The version of the software.
 - *FPGA:* The version of the FPGA firmware.
 - *Storage:* The used and free space on the memory card.
 - *Lens:* The field of view of the lens.
 - *Battery:* The remaining battery capacity (in percent).
 - *Register camera...:* This will start the registration wizard. For more information, see section 7 *Register the camera*, page 14.
 - *Licenses:* Open-source license information.

Table of contents

30.1	Online field-of-view calculator.....	105
30.2	Note about technical data.....	105
30.3	Note about authoritative versions.....	105
30.4	FLIR T1010 12°.....	106
30.5	FLIR T1010 28°.....	111
30.6	FLIR T1010 45°.....	116
30.7	FLIR T1020 12°.....	121
30.8	FLIR T1020 28°.....	127
30.9	FLIR T1020 45°.....	133
30.10	FLIR T1020 28° and 12°.....	139
30.11	FLIR T1020 28° and 45°.....	145
30.12	FLIR T1020 28°, 12°, and 45°.....	151
30.13	FLIR T1030sc 12°.....	157
30.14	FLIR T1030sc 28°.....	164
30.15	FLIR T1030sc 45°.....	171
30.16	FLIR T1040 12°.....	178
30.17	FLIR T1040 28°.....	184
30.18	FLIR T1040 45°.....	190
30.19	FLIR T1050sc 12°.....	196
30.20	FLIR T1050sc 28°.....	203
30.21	FLIR T1050sc 45°.....	210
30.22	IR lens, f=36 mm (28°) with case.....	217
30.23	Close-up lens 3x (51 µm) with case.....	219
30.24	IR lens f=21.2 mm (45°) with case.....	220
30.25	IR lens f=83.4 mm (12°) with case.....	222
30.26	FLIR T10xx SC kit.....	224

30.1 Online field-of-view calculator

Please visit <http://support.flir.com> and click the photo of the camera series for field-of-view tables for all lens-camera combinations.

30.2 Note about technical data

FLIR Systems reserves the right to change specifications at any time without prior notice. Please check <http://support.flir.com> for latest changes.

30.3 Note about authoritative versions

The authoritative version of this publication is English. In the event of divergences due to translation errors, the English text has precedence.

Any late changes are first implemented in English.

30.4 FLIR T1010 12°

P/N: 72502-0501

Rev.: 46605

General description	
The FLIR T1010 is designed for the expert requiring the highest performance and the latest technology available. The camera combines excellent ergonomics and feature-rich flexibility with superior image quality at an infrared resolution of 1024 × 768 pixels.	
Benefits:	
<ul style="list-style-type: none"> • Flexible and feature rich: A wide variety of measuring and analysis functions make the FLIR T1010 flexible for your every need. Two programmable buttons provide easy access to favorite functions. • Highest performance with the latest technology: The FLIR T1010 is equipped with the innovative Multi Spectral Dynamic Imaging (MSX) feature, which produces an image richer in detail than ever before. With its continuous autofocus, the FLIR T1010 is a fully automatic infrared camera. • Support for UltraMax: When enabling UltraMax in the camera, the resolution of images can be substantially enhanced when importing the images into FLIR Tools. 	
Imaging and optical data	
IR resolution	1024 × 768 pixels
MSX resolution	1024 × 768 pixels
UltraMax	Yes
Thermal sensitivity/NETD	<25 mK @ +30°C (+86°F)
Field of view (FOV)	28° × 21°
Minimum IR focus distance	0.4 m (1.32 ft.)
Minimum IR–visual alignment distance	0.4 m (1.32 ft.)
Focal length	36 mm (1.42 in.)
Spatial resolution (IFOV)	0.47 mrad
Lens identification	Automatic
F-number	1.15
Image frequency	30 Hz
Focus	One shot or manual
Digital zoom	1–8× continuous
Digital image enhancement	Adaptive digital noise reduction
Detector data	
Detector type	Focal plane array (FPA), uncooled microbolometer
Spectral range	7.5–14 μm
Detector pitch	17 μm
Image presentation	
Display	Built-in touch screen, 4.3 in. wide screen LCD, 800 × 480 pixels
Display type	Capacitive touch screen
Auto orientation	Automatic landscape or portrait
Automatic image adjustment, type	Standard or histogram based on the image content
Manual image adjustment	Linear based, possible to adjust level/span/max./min.

Image presentation modes		
Image modes	Thermal, thermal MSX, digital camera	
Infrared image	Full color infrared image	
Visual image	Full color visual image	
Multi Spectral Dynamic Imaging (MSX)	Thermal image with enhanced detail presentation	
Gallery	<ul style="list-style-type: none"> Review thumbnail/full image on the camera Edit measurements/palettes/image modes on the camera 	

Measurement		
Object temperature range		Accuracy
-40 to +150°C (-40 to +302°F)	-40 to +5°C (-40 to +41°F)	±2°C (±3.6°F)
	+5 to +100°C (+41 to +212°F)	±2°C (±3.6°F)
	+100 to +150°C (+212 to +302°F)	±2%
0 to +650°C (+32 to +1202°F)	0 to +100°C (+32 to +212°F)	±2°C (±3.6°F)
	+100 to +650°C (+212 to +1202°F)	±2%

Measurement analysis	
Spotmeter	1
Area	1 box with max./min./average
Profile	No
Automatic hot/cold detection	Auto hot or cold spotmeter markers within the area
Measurement presets	No measurements, Center spot, Hot spot, Cold spot, User preset 1, User preset 2
User presets	The user can select and combine measurements from one box, one delta.
Difference temperature	Delta temperature between the measurement functions and the reference temperature
Reference temperature	Yes
Atmospheric transmission correction	Automatic, based on the inputs for distance, atmospheric temperature, and relative humidity
Optics transmission correction	Automatic, based on signals from internal sensors
Emissivity correction	Variable from 0.01 to 1.0 or selected from the materials list
Reflected apparent temperature correction	Automatic, based on the input of the reflected temperature
External optics/windows correction	Automatic, based on the inputs of the window transmission and temperature
Measurement corrections	Emissivity, reflected temperature, relative humidity, atmospheric temperature, object distance, external infrared window compensation
Colors (palettes)	Iron, Rainbow, Rainbow HC, White hot, Black hot, Arctic, Lava

Set-up	
Set-up commands	Save options, Programmable button, Reset options, Set up camera, Language, Time & units, Camera information
Languages	Arabic, Czech, Danish, Dutch, English, Finnish, French, German, Greek, Hungarian, Italian, Japanese, Korean, Norwegian, Polish, Portuguese, Russian, simplified Chinese, Swedish, traditional Chinese, Turkish
Service functions	
Camera software update	Use PC software FLIR Tools
Storage of images	
Image storage	Standard JPEG, including digital image and measurement data, on a memory card
Storage media	Removable media SD or SDHC card. Class 10 or better recommended
Image storage mode	<ul style="list-style-type: none"> • Simultaneous storage of thermal and digital images in the same JPEG file • Option to store a digital photo as a separate JPEG file
File formats	<ul style="list-style-type: none"> • Standard JPEG, measurement data included • No CSQ, measurement data included • No CSQ storage on camera
File formats, visual	Standard JPEG, automatically associated with the corresponding thermal image
Video recording in camera	
Non-radiometric IR-video recording	H.264 to the memory card
Visual video recording	H.264 to the memory card
Video streaming	
Radiometric IR-video streaming	Real-time radiometric streaming (RTRS) via USB
Non-radiometric IR-video streaming	H.264 video using USB
Visual video streaming	H.264 video using USB
Digital camera	
Built-in digital camera	5 Mpixel with LED light
Digital camera	Field of view adapts to the infrared lens
Video lamp	Built-in LED light
Laser pointer	
Laser	Activated by a dedicated button
Laser alignment	Position is automatically displayed on the infrared image
Laser classification	Class 2
Laser type	Semiconductor AlGaInP diode laser, 1 mW, 635 nm (red)
Data communication interfaces	
Interfaces	USB Micro-B, HDMI
SD Card	One card slot for removable SD memory cards

USB	
USB	USB Micro-B: data transfer to and from a PC, uncompressed colorized video
USB, standard	<ul style="list-style-type: none"> • USB 2.0 High Speed • USB Micro-B connector
Radio	
Antenna	Internal (disabled)
Power system	
Battery type	Rechargeable Li ion battery
Battery operating time	>2.5 hours at 25°C (+68°F) and typical use
Charging system	In camera (AC adapter or 12 V from a vehicle) or two-bay charger
Charging time	2.5 hours to 90% capacity, charging status indicated by LEDs
Charging temperature	0°C to +45°C (+32°F to +113°F), except for the Korean market: +10°C to +45°C (+50°F to +113°F)
External power operation	AC adapter 90–260 V AC, 50/60 Hz or 12 V from a vehicle (cable with a standard plug, optional)
Power management	Automatic power-off functionality, user configurable between 5 minutes, 20 minutes, and no automatic shutdown
Environmental data	
Operating temperature range	–15°C to +50°C (+5°F to +122°F)
Storage temperature range	–40 to +70°C (–40 to +158°F)
Humidity (operating and storage)	IEC 60068-2-30 / 24 hours, 95% relative humidity, 25–40°C (77–104°F) / 2 cycles
EMC	<ul style="list-style-type: none"> • ETSI EN 301 489-1 (radio) • ETSI EN 301 489-17 • EN 61000-6-2 (Immunity) • EN 61000-6-3 (Emission) • FCC 47 CFR Part 15 Class B (Emission) • ICES-003
Radio spectrum	<ul style="list-style-type: none"> • ETSI EN 300 328 • FCC Part 15.247 • RSS-247 Issue 2
Encapsulation	IP 54 (IEC 60529)
Shock	25 g (IEC 60068-2-29)
Vibration	2 g (IEC 60068-2-6)
Safety	EN/UL/CSA/PSE 60950-1
Ergonomics	The viewfinder plus the 120° rotating optical block allow you to point the camera in multiple directions while maintaining a comfortable position
Physical data	
Weight	1.9 kg (4.3 lb.)
Camera size, excl. lens (L x W x H)	167.2 mm x 204.5 mm x 180.4 mm (6.6 in. x 8.0 in. x 7.1 in.)
Tripod mounting	UNC ¼"-20
Housing material	Magnesium

Warranty information	
Warranty	See http://www.flir.com/warranty/ .
Shipping information	
List of contents	<ul style="list-style-type: none"> • Infrared camera with lens • Battery (2 ea.) • Battery charger • Calibration certificate • FLIR Tools+ license card • Hard transport case • HDMI-HDMI cable • Lens cap • Memory card • Neck strap • Power supply, including multi-plugs • Printed documentation • USB cable, Std A to Micro-B
EAN-13	7332558014417
UPC-12	845188016470
Country of origin	Sweden

Supplies & accessories:

- T199064; IR lens f=36mm (28°) with case
- T199066; IR lens f=21.2mm (45°) with case
- T199077; IR lens f=83.4mm (12°) with case
- T910814; Power supply, incl. multi plugs
- T198126; Battery charger, incl. power supply with multi plugs T6xx
- T199364ACC; Battery Li-ion 3.65 V, 8.5 Ah, 32 Wh
- T911650ACC; Memory card SD Card 8 GB
- T198509; Cigarette lighter adapter kit, 12 VDC, 1.2 m/3.9 ft.
- T910930ACC; HDMI type C to DVI cable 1.5 m
- T910891ACC; HDMI type C to HDMI type A cable 1.5 m
- T911093; Tool belt
- T198533; USB cable Std A <-> Micro B
- T198586; FLIR Reporter Professional (license only)
- T198584; FLIR Tools
- T198583; FLIR Tools+ (download card incl. license key)
- DSW-10000; FLIR IR Camera Player
- APP-10002; FLIR Tools Mobile (Android Application)
- APP-10003; FLIR Tools Mobile (iPad/iPhone Application)
- APP-10004; FLIR Tools (MacOS Application)
- T199233; FLIR Atlas SDK for .NET
- T199234; FLIR Atlas SDK for MATLAB

30.5 FLIR T1010 28°

P/N: 72502-0502

Rev.: 46606

General description	
The FLIR T1010 is designed for the expert requiring the highest performance and the latest technology available. The camera combines excellent ergonomics and feature-rich flexibility with superior image quality at an infrared resolution of 1024 × 768 pixels.	
Benefits:	
<ul style="list-style-type: none"> • Flexible and feature rich: A wide variety of measuring and analysis functions make the FLIR T1010 flexible for your every need. Two programmable buttons provide easy access to favorite functions. • Highest performance with the latest technology: The FLIR T1010 is equipped with the innovative Multi Spectral Dynamic Imaging (MSX) feature, which produces an image richer in detail than ever before. With its continuous autofocus, the FLIR T1010 is a fully automatic infrared camera. • Support for UltraMax: When enabling UltraMax in the camera, the resolution of images can be substantially enhanced when importing the images into FLIR Tools. 	
Imaging and optical data	
IR resolution	1024 × 768 pixels
MSX resolution	1024 × 768 pixels
UltraMax	Yes
Thermal sensitivity/NETD	<25 mK @ +30°C (+86°F)
Field of view (FOV)	28° × 21°
Minimum IR focus distance	0.4 m (1.32 ft.)
Minimum IR–visual alignment distance	0.4 m (1.32 ft.)
Focal length	36 mm (1.42 in.)
Spatial resolution (IFOV)	0.47 mrad
Lens identification	Automatic
F-number	1.15
Image frequency	30 Hz
Focus	One shot or manual
Digital zoom	1–8× continuous
Digital image enhancement	Adaptive digital noise reduction
Detector data	
Detector type	Focal plane array (FPA), uncooled microbolometer
Spectral range	7.5–14 μm
Detector pitch	17 μm
Image presentation	
Display	Built-in touch screen, 4.3 in. wide screen LCD, 800 × 480 pixels
Display type	Capacitive touch screen
Auto orientation	Automatic landscape or portrait
Automatic image adjustment, type	Standard or histogram based on the image content
Manual image adjustment	Linear based, possible to adjust level/span/max./min.

Image presentation modes		
Image modes	Thermal, thermal MSX, digital camera	
Infrared image	Full color infrared image	
Visual image	Full color visual image	
Multi Spectral Dynamic Imaging (MSX)	Thermal image with enhanced detail presentation	
Gallery	<ul style="list-style-type: none"> Review thumbnail/full image on the camera Edit measurements/palettes/image modes on the camera 	

Measurement		
Object temperature range		Accuracy
-40 to +150°C (-40 to +302°F)	-40 to +5°C (-40 to +41°F)	±2°C (±3.6°F)
	+5 to +100°C (+41 to +212°F)	±2°C (±3.6°F)
	+100 to +150°C (+212 to +302°F)	±2%
0 to +650°C (+32 to +1202°F)	0 to +100°C (+32 to +212°F)	±2°C (±3.6°F)
	+100 to +650°C (+212 to +1202°F)	±2%

Measurement analysis	
Spotmeter	1
Area	1 box with max./min./average
Profile	No
Automatic hot/cold detection	Auto hot or cold spotmeter markers within the area
Measurement presets	No measurements, Center spot, Hot spot, Cold spot, User preset 1, User preset 2
User presets	The user can select and combine measurements from one box, one delta.
Difference temperature	Delta temperature between the measurement functions and the reference temperature
Reference temperature	Yes
Atmospheric transmission correction	Automatic, based on the inputs for distance, atmospheric temperature, and relative humidity
Optics transmission correction	Automatic, based on signals from internal sensors
Emissivity correction	Variable from 0.01 to 1.0 or selected from the materials list
Reflected apparent temperature correction	Automatic, based on the input of the reflected temperature
External optics/windows correction	Automatic, based on the inputs of the window transmission and temperature
Measurement corrections	Emissivity, reflected temperature, relative humidity, atmospheric temperature, object distance, external infrared window compensation
Colors (palettes)	Iron, Rainbow, Rainbow HC, White hot, Black hot, Arctic, Lava

Set-up	
Set-up commands	Save options, Programmable button, Reset options, Set up camera, Language, Time & units, Camera information
Languages	Arabic, Czech, Danish, Dutch, English, Finnish, French, German, Greek, Hungarian, Italian, Japanese, Korean, Norwegian, Polish, Portuguese, Russian, simplified Chinese, Swedish, traditional Chinese, Turkish
Service functions	
Camera software update	Use PC software FLIR Tools
Storage of images	
Image storage	Standard JPEG, including digital image and measurement data, on a memory card
Storage media	Removable media SD or SDHC card. Class 10 or better recommended
Image storage mode	<ul style="list-style-type: none"> • Simultaneous storage of thermal and digital images in the same JPEG file • Option to store a digital photo as a separate JPEG file
File formats	<ul style="list-style-type: none"> • Standard JPEG, measurement data included • No CSQ, measurement data included • No CSQ storage on camera
File formats, visual	Standard JPEG, automatically associated with the corresponding thermal image
Video recording in camera	
Non-radiometric IR-video recording	H.264 to the memory card
Visual video recording	H.264 to the memory card
Video streaming	
Radiometric IR-video streaming	Real-time radiometric streaming (RTRS) via USB
Non-radiometric IR-video streaming	H.264 video using USB
Visual video streaming	H.264 video using USB
Digital camera	
Built-in digital camera	5 Mpixel with LED light
Digital camera	Field of view adapts to the infrared lens
Video lamp	Built-in LED light
Laser pointer	
Laser	Activated by a dedicated button
Laser alignment	Position is automatically displayed on the infrared image
Laser classification	Class 2
Laser type	Semiconductor AlGaInP diode laser, 1 mW, 635 nm (red)
Data communication interfaces	
Interfaces	USB Micro-B, HDMI
SD Card	One card slot for removable SD memory cards

USB	
USB	USB Micro-B: data transfer to and from a PC, uncompressed colorized video
USB, standard	<ul style="list-style-type: none"> • USB 2.0 High Speed • USB Micro-B connector
Radio	
Antenna	Internal (disabled)
Power system	
Battery type	Rechargeable Li ion battery
Battery operating time	>2.5 hours at 25°C (+68°F) and typical use
Charging system	In camera (AC adapter or 12 V from a vehicle) or two-bay charger
Charging time	2.5 hours to 90% capacity, charging status indicated by LEDs
Charging temperature	0°C to +45°C (+32°F to +113°F), except for the Korean market: +10°C to +45°C (+50°F to +113°F)
External power operation	AC adapter 90–260 V AC, 50/60 Hz or 12 V from a vehicle (cable with a standard plug, optional)
Power management	Automatic power-off functionality, user configurable between 5 minutes, 20 minutes, and no automatic shutdown
Environmental data	
Operating temperature range	–15°C to +50°C (+5°F to +122°F)
Storage temperature range	–40 to +70°C (–40 to +158°F)
Humidity (operating and storage)	IEC 60068-2-30 / 24 hours, 95% relative humidity, 25–40°C (77–104°F) / 2 cycles
EMC	<ul style="list-style-type: none"> • ETSI EN 301 489-1 (radio) • ETSI EN 301 489-17 • EN 61000-6-2 (Immunity) • EN 61000-6-3 (Emission) • FCC 47 CFR Part 15 Class B (Emission) • ICES-003
Radio spectrum	<ul style="list-style-type: none"> • ETSI EN 300 328 • FCC Part 15.247 • RSS-247 Issue 2
Encapsulation	IP 54 (IEC 60529)
Shock	25 g (IEC 60068-2-29)
Vibration	2 g (IEC 60068-2-6)
Safety	EN/UL/CSA/PSE 60950-1
Ergonomics	The viewfinder plus the 120° rotating optical block allow you to point the camera in multiple directions while maintaining a comfortable position
Physical data	
Weight	1.9 kg (4.3 lb.)
Camera size, excl. lens (L x W x H)	167.2 mm x 204.5 mm x 180.4 mm (6.6 in. x 8.0 in. x 7.1 in.)
Tripod mounting	UNC ¼"-20
Housing material	Magnesium

Warranty information	
Warranty	See http://www.flir.com/warranty/ .
Shipping information	
List of contents	<ul style="list-style-type: none"> • Infrared camera with lens • Battery (2 ea.) • Battery charger • Calibration certificate • FLIR Tools+ license card • Hard transport case • HDMI-HDMI cable • Lens cap • Memory card • Neck strap • Power supply, including multi-plugs • Printed documentation • USB cable, Std A to Micro-B
EAN-13	7332558014400
UPC-12	845188016456
Country of origin	Sweden

Supplies & accessories:

- T199064; IR lens f=36mm (28°) with case
- T199066; IR lens f=21.2mm (45°) with case
- T199077; IR lens f=83.4mm (12°) with case
- T910814; Power supply, incl. multi plugs
- T198126; Battery charger, incl. power supply with multi plugs T6xx
- T199364ACC; Battery Li-ion 3.65 V, 8.5 Ah, 32 Wh
- T911650ACC; Memory card SD Card 8 GB
- T198509; Cigarette lighter adapter kit, 12 VDC, 1.2 m/3.9 ft.
- T910930ACC; HDMI type C to DVI cable 1.5 m
- T910891ACC; HDMI type C to HDMI type A cable 1.5 m
- T911093; Tool belt
- T198533; USB cable Std A <-> Micro B
- T198586; FLIR Reporter Professional (license only)
- T198584; FLIR Tools
- T198583; FLIR Tools+ (download card incl. license key)
- DSW-10000; FLIR IR Camera Player
- APP-10002; FLIR Tools Mobile (Android Application)
- APP-10003; FLIR Tools Mobile (iPad/iPhone Application)
- APP-10004; FLIR Tools (MacOS Application)
- T199233; FLIR Atlas SDK for .NET
- T199234; FLIR Atlas SDK for MATLAB

30.6 FLIR T1010 45°

P/N: 72502-0503

Rev.: 46607

General description	
The FLIR T1010 is designed for the expert requiring the highest performance and the latest technology available. The camera combines excellent ergonomics and feature-rich flexibility with superior image quality at an infrared resolution of 1024 × 768 pixels.	
Benefits:	
<ul style="list-style-type: none"> • Flexible and feature rich: A wide variety of measuring and analysis functions make the FLIR T1010 flexible for your every need. Two programmable buttons provide easy access to favorite functions. • Highest performance with the latest technology: The FLIR T1010 is equipped with the innovative Multi Spectral Dynamic Imaging (MSX) feature, which produces an image richer in detail than ever before. With its continuous autofocus, the FLIR T1010 is a fully automatic infrared camera. • Support for UltraMax: When enabling UltraMax in the camera, the resolution of images can be substantially enhanced when importing the images into FLIR Tools. 	
Imaging and optical data	
IR resolution	1024 × 768 pixels
MSX resolution	1024 × 768 pixels
UltraMax	Yes
Thermal sensitivity/NETD	<25 mK @ +30°C (+86°F)
Field of view (FOV)	28° × 21°
Minimum IR focus distance	0.4 m (1.32 ft.)
Minimum IR–visual alignment distance	0.4 m (1.32 ft.)
Focal length	36 mm (1.42 in.)
Spatial resolution (IFOV)	0.47 mrad
Lens identification	Automatic
F-number	1.15
Image frequency	30 Hz
Focus	One shot or manual
Digital zoom	1–8× continuous
Digital image enhancement	Adaptive digital noise reduction
Detector data	
Detector type	Focal plane array (FPA), uncooled microbolometer
Spectral range	7.5–14 μm
Detector pitch	17 μm
Image presentation	
Display	Built-in touch screen, 4.3 in. wide screen LCD, 800 × 480 pixels
Display type	Capacitive touch screen
Auto orientation	Automatic landscape or portrait
Automatic image adjustment, type	Standard or histogram based on the image content
Manual image adjustment	Linear based, possible to adjust level/span/max./min.

Image presentation modes		
Image modes	Thermal, thermal MSX, digital camera	
Infrared image	Full color infrared image	
Visual image	Full color visual image	
Multi Spectral Dynamic Imaging (MSX)	Thermal image with enhanced detail presentation	
Gallery	<ul style="list-style-type: none"> Review thumbnail/full image on the camera Edit measurements/palettes/image modes on the camera 	

Measurement		
Object temperature range		Accuracy
-40 to +150°C (-40 to +302°F)	-40 to +5°C (-40 to +41°F)	±2°C (±3.6°F)
	+5 to +100°C (+41 to +212°F)	±2°C (±3.6°F)
	+100 to +150°C (+212 to +302°F)	±2%
0 to +650°C (+32 to +1202°F)	0 to +100°C (+32 to +212°F)	±2°C (±3.6°F)
	+100 to +650°C (+212 to +1202°F)	±2%

Measurement analysis	
Spotmeter	1
Area	1 box with max./min./average
Profile	No
Automatic hot/cold detection	Auto hot or cold spotmeter markers within the area
Measurement presets	No measurements, Center spot, Hot spot, Cold spot, User preset 1, User preset 2
User presets	The user can select and combine measurements from one box, one delta.
Difference temperature	Delta temperature between the measurement functions and the reference temperature
Reference temperature	Yes
Atmospheric transmission correction	Automatic, based on the inputs for distance, atmospheric temperature, and relative humidity
Optics transmission correction	Automatic, based on signals from internal sensors
Emissivity correction	Variable from 0.01 to 1.0 or selected from the materials list
Reflected apparent temperature correction	Automatic, based on the input of the reflected temperature
External optics/windows correction	Automatic, based on the inputs of the window transmission and temperature
Measurement corrections	Emissivity, reflected temperature, relative humidity, atmospheric temperature, object distance, external infrared window compensation
Colors (palettes)	Iron, Rainbow, Rainbow HC, White hot, Black hot, Arctic, Lava

Set-up	
Set-up commands	Save options, Programmable button, Reset options, Set up camera, Language, Time & units, Camera information
Languages	Arabic, Czech, Danish, Dutch, English, Finnish, French, German, Greek, Hungarian, Italian, Japanese, Korean, Norwegian, Polish, Portuguese, Russian, simplified Chinese, Swedish, traditional Chinese, Turkish
Service functions	
Camera software update	Use PC software FLIR Tools
Storage of images	
Image storage	Standard JPEG, including digital image and measurement data, on a memory card
Storage media	Removable media SD or SDHC card. Class 10 or better recommended
Image storage mode	<ul style="list-style-type: none"> • Simultaneous storage of thermal and digital images in the same JPEG file • Option to store a digital photo as a separate JPEG file
File formats	<ul style="list-style-type: none"> • Standard JPEG, measurement data included • No CSQ, measurement data included • No CSQ storage on camera
File formats, visual	Standard JPEG, automatically associated with the corresponding thermal image
Video recording in camera	
Non-radiometric IR-video recording	H.264 to the memory card
Visual video recording	H.264 to the memory card
Video streaming	
Radiometric IR-video streaming	Real-time radiometric streaming (RTRS) via USB
Non-radiometric IR-video streaming	H.264 video using USB
Visual video streaming	H.264 video using USB
Digital camera	
Built-in digital camera	5 Mpixel with LED light
Digital camera	Field of view adapts to the infrared lens
Video lamp	Built-in LED light
Laser pointer	
Laser	Activated by a dedicated button
Laser alignment	Position is automatically displayed on the infrared image
Laser classification	Class 2
Laser type	Semiconductor AlGaInP diode laser, 1 mW, 635 nm (red)
Data communication interfaces	
Interfaces	USB Micro-B, HDMI
SD Card	One card slot for removable SD memory cards

USB	
USB	USB Micro-B: data transfer to and from a PC, uncompressed colorized video
USB, standard	<ul style="list-style-type: none"> • USB 2.0 High Speed • USB Micro-B connector
Radio	
Antenna	Internal (disabled)
Power system	
Battery type	Rechargeable Li ion battery
Battery operating time	>2.5 hours at 25°C (+68°F) and typical use
Charging system	In camera (AC adapter or 12 V from a vehicle) or two-bay charger
Charging time	2.5 hours to 90% capacity, charging status indicated by LEDs
Charging temperature	0°C to +45°C (+32°F to +113°F), except for the Korean market: +10°C to +45°C (+50°F to +113°F)
External power operation	AC adapter 90–260 V AC, 50/60 Hz or 12 V from a vehicle (cable with a standard plug, optional)
Power management	Automatic power-off functionality, user configurable between 5 minutes, 20 minutes, and no automatic shutdown
Environmental data	
Operating temperature range	–15°C to +50°C (+5°F to +122°F)
Storage temperature range	–40 to +70°C (–40 to +158°F)
Humidity (operating and storage)	IEC 60068-2-30 / 24 hours, 95% relative humidity, 25–40°C (77–104°F) / 2 cycles
EMC	<ul style="list-style-type: none"> • ETSI EN 301 489-1 (radio) • ETSI EN 301 489-17 • EN 61000-6-2 (Immunity) • EN 61000-6-3 (Emission) • FCC 47 CFR Part 15 Class B (Emission) • ICES-003
Radio spectrum	<ul style="list-style-type: none"> • ETSI EN 300 328 • FCC Part 15.247 • RSS-247 Issue 2
Encapsulation	IP 54 (IEC 60529)
Shock	25 g (IEC 60068-2-29)
Vibration	2 g (IEC 60068-2-6)
Safety	EN/UL/CSA/PSE 60950-1
Ergonomics	The viewfinder plus the 120° rotating optical block allow you to point the camera in multiple directions while maintaining a comfortable position
Physical data	
Weight	1.9 kg (4.3 lb.)
Camera size, excl. lens (L x W x H)	167.2 mm x 204.5 mm x 180.4 mm (6.6 in. x 8.0 in. x 7.1 in.)
Tripod mounting	UNC ¼"-20
Housing material	Magnesium

Warranty information	
Warranty	See http://www.flir.com/warranty/ .
Shipping information	
List of contents	<ul style="list-style-type: none"> • Infrared camera with lens • Battery (2 ea.) • Battery charger • Calibration certificate • FLIR Tools+ license card • Hard transport case • HDMI-HDMI cable • Lens cap • Memory card • Neck strap • Power supply, including multi-plugs • Printed documentation • USB cable, Std A to Micro-B
EAN-13	7332558014424
UPC-12	845188016487
Country of origin	Sweden

Supplies & accessories:

- T199064; IR lens f=36mm (28°) with case
- T199066; IR lens f=21.2mm (45°) with case
- T199077; IR lens f=83.4mm (12°) with case
- T910814; Power supply, incl. multi plugs
- T198126; Battery charger, incl. power supply with multi plugs T6xx
- T199364ACC; Battery Li-ion 3.65 V, 8.5 Ah, 32 Wh
- T911650ACC; Memory card SD Card 8 GB
- T198509; Cigarette lighter adapter kit, 12 VDC, 1.2 m/3.9 ft.
- T910930ACC; HDMI type C to DVI cable 1.5 m
- T910891ACC; HDMI type C to HDMI type A cable 1.5 m
- T911093; Tool belt
- T198533; USB cable Std A <-> Micro B
- T198586; FLIR Reporter Professional (license only)
- T198584; FLIR Tools
- T198583; FLIR Tools+ (download card incl. license key)
- DSW-10000; FLIR IR Camera Player
- APP-10002; FLIR Tools Mobile (Android Application)
- APP-10003; FLIR Tools Mobile (iPad/iPhone Application)
- APP-10004; FLIR Tools (MacOS Application)
- T199233; FLIR Atlas SDK for .NET
- T199234; FLIR Atlas SDK for MATLAB

30.7 FLIR T1020 12°

P/N: 72501-0101

Rev.: 46139

General description	
The FLIR T1020 is designed for the expert requiring the highest performance and the latest technology available. The camera combines excellent ergonomics and feature-rich flexibility with superior image quality at an infrared resolution of 1024 × 768 pixels.	
Benefits:	
<ul style="list-style-type: none"> • Flexible and feature rich: A wide variety of measuring and analysis functions make the FLIR T1020 flexible for your every need. Two programmable buttons provide easy access to favorite functions. • Highest performance with the latest technology: The FLIR T1020 is equipped with the innovative Multi Spectral Dynamic Imaging (MSX) feature, which produces an image richer in detail than ever before. With its continuous autofocus, the FLIR T1020 is a fully automatic infrared camera. • Support for UltraMax: When enabling UltraMax in the camera, the resolution of images can be substantially enhanced when importing the images into FLIR Tools. 	
Imaging and optical data	
IR resolution	1024 × 768 pixels
MSX resolution	1024 × 768 pixels
UltraMax	Yes
Thermal sensitivity/NETD	<20 mK @ +30°C (+86°F)
Field of view (FOV)	12° × 9°
Minimum IR focus distance	1.3 m (4.26 ft.)
Minimum IR–visual alignment distance	1.3 m (4.26 ft.)
Focal length	83.4 mm (3.28 in.)
Spatial resolution (IFOV)	0.20 mrad
Lens identification	Automatic
F-number	1.2
Image frequency	30 Hz
Focus	One shot or manual
Digital zoom	1–8× continuous
Digital image enhancement	Adaptive digital noise reduction
Detector data	
Detector type	Focal plane array (FPA), uncooled microbolometer
Spectral range	7.5–14 μm
Detector pitch	17 μm
Image presentation	
Display	Built-in touch screen, 4.3 in. wide screen LCD, 800 × 480 pixels
Display type	Capacitive touch screen
Auto orientation	Automatic landscape or portrait
Viewfinder	Built-in 800 × 480 pixels
Automatic image adjustment	Continuous, histogram based
Automatic image adjustment, type	Standard or histogram based on the image content
Manual image adjustment	Linear based, possible to adjust level/span/max./min.

Image presentation modes	
Image modes	Thermal, thermal MSX, picture in picture, digital camera
Infrared image	Full color infrared image
Visual image	Full color visual image
Multi Spectral Dynamic Imaging (MSX)	Thermal image with enhanced detail presentation
Picture in Picture	Resizable and movable infrared area on the visual image
Gallery	<ul style="list-style-type: none"> Review thumbnail/full image on the camera Edit measurements/palettes/image modes on the camera

Measurement		
Object temperature range		Accuracy
-40 to +150°C (-40 to +302°F)	-40 to +5°C (-40 to +41°F)	±2°C (±3.6°F)
	+5 to +100°C (+41 to +212°F)	±1°C (±1.8°F)
	+100 to +150°C (+212 to +302°F)	±1%
0 to +650°C (+32 to +1202°F)	0 to +100°C (+32 to +212°F)	±2°C (±3.6°F)
	+100 to +650°C (+212 to +1202°F)	±2%
+300 to +2000°C (+572 to +3632°F)	+300 to +2000°C (+572 to +3632°F)	±2%

**NOTE**

For HSI use, above 30 Hz frame rate, the typical accuracy will be ±2.5°C (±4.5°F), or 2.5% of reading @ 25°C (77°F).

Measurement analysis	
Spotmeter	10
Area	5 + 5 areas (boxes and circles) with max./min./average
Profile	1 line profile with max./min. temperature
Automatic hot/cold detection	Auto hot or cold spotmeter markers within the area and profile
Measurement presets	No measurements, Center spot, Hot spot, Cold spot, User preset 1, User preset 2
User presets	The user can select and combine measurements from any number of spots/boxes/circles/profiles/delta
Difference temperature	Delta temperature between the measurement functions and the reference temperature
Reference temperature	Manually set using the difference temperature
Atmospheric transmission correction	Automatic, based on the inputs for distance, atmospheric temperature, and relative humidity
Optics transmission correction	Automatic, based on signals from internal sensors
Emissivity correction	Variable from 0.01 to 1.0 or selected from the materials list
Reflected apparent temperature correction	Automatic, based on the input of the reflected temperature
External optics/windows correction	Automatic, based on the inputs of the window transmission and temperature

Measurement analysis	
Measurement corrections	Emissivity, reflected temperature, relative humidity, atmospheric temperature, object distance, external infrared window compensation
Colors (palettes)	Iron, Rainbow, Rainbow HC, White hot, Black hot, Arctic, Lava
Alarm	
Color alarm (isotherm)	<ul style="list-style-type: none"> • Above • Below • Interval • Condensation (moisture/humidity/dewpoint) • Insulation
Measurement function alarm	Audible/visual alarms (above/below) on any selected measurement function
Set-up	
Set-up commands	Define user presets, Save options, Programmable button, Reset options, Set up camera, Wi-Fi, GPS & compass, Bluetooth, Language, Time & units, Camera information
Languages	Arabic, Czech, Danish, Dutch, English, Finnish, French, German, Greek, Hungarian, Italian, Japanese, Korean, Norwegian, Polish, Portuguese, Russian, simplified Chinese, Swedish, traditional Chinese, Turkish
Service functions	
Camera software update	Use PC software FLIR Tools
Storage of images	
Image storage	Standard JPEG, including digital image and measurement data, on a memory card
Storage media	Removable media SD or SDHC card. Class 10 or better recommended
Image storage mode	<ul style="list-style-type: none"> • Simultaneous storage of thermal and digital images in the same JPEG file • Option to store a digital photo as a separate JPEG file
Time lapse	15 seconds to 24 hours
File formats	<ul style="list-style-type: none"> • Standard JPEG, measurement data included • CSQ, measurement data included
File formats, visual	Standard JPEG, automatically associated with the corresponding thermal image
Image annotations	
Voice	60 seconds (via Bluetooth) stored with the image
Text	Add table, select between predefined templates
Image description	Add short note (stored in the JPEG exif tag)
Sketch	<ul style="list-style-type: none"> • Draw on the thermal/digital image or add predefined stamps • Separate PC software with extensive report generation
METERLiNK	Wireless connection (Bluetooth) to: FLIR meters with METERLiNK

Geographic Information System	
GPS	Location data automatically added to every image from the built-in GPS
Compass	Camera direction automatically added to every image
Video recording in camera	
Radiometric IR-video recording	Real-time radiometric recording (RTRR) to the memory card
Non-radiometric IR-video recording	H.264 to the memory card
Visual video recording	H.264 to the memory card
Video streaming	
Radiometric IR-video streaming	Real-time radiometric streaming (RTRS) via USB
Non-radiometric IR-video streaming	<ul style="list-style-type: none"> • H.264 video using Wi-Fi • H.264 video using USB
Visual video streaming	<ul style="list-style-type: none"> • H.264 video using Wi-Fi • H.264 video using USB
Digital camera	
Built-in digital camera	5 Mpixel with LED light
Digital camera	Field of view adapts to the infrared lens
Video lamp	Built-in LED light
Laser pointer	
Laser	Activated by a dedicated button
Laser alignment	Position is automatically displayed on the infrared image
Laser classification	Class 2
Laser type	Semiconductor AlGaInP diode laser, 1 mW, 635 nm (red)
Data communication interfaces	
Interfaces	USB Micro-B, Bluetooth, Wi-Fi, HDMI
METERLiNK/Bluetooth	Communication with headset and external sensors
Wi-Fi	Infrastructure (network) or AP
SD Card	One card slot for removable SD memory cards
Audio	Microphone headset via Bluetooth for the voice annotation of images
USB	
USB	USB Micro-B: data transfer to and from a PC, uncompressed colorized video
USB, standard	<ul style="list-style-type: none"> • USB 2.0 High Speed • USB Micro-B connector
Video	
Video out	<ul style="list-style-type: none"> • HDMI 640 × 480 • HDMI 1280 × 720 • DVI 640 × 480 • DVI 800 × 600
Video, connector type	HDMI type C

Radio	
Wi-Fi	<ul style="list-style-type: none"> Standard: 802.11 b/g/n Frequency range: 2412–2462 MHz Max. output power: 15 dBm
METERLiNK/Bluetooth	Frequency range: 2402–2480 MHz, supports 2.1 and 4.0
Antenna	Internal
Power system	
Battery type	Rechargeable Li ion battery
Battery operating time	>2.5 hours at 25°C (+68°F) and typical use
Charging system	In camera (AC adapter or 12 V from a vehicle) or two-bay charger
Charging time	2.5 hours to 90% capacity, charging status indicated by LEDs
Charging temperature	0°C to +45°C (+32°F to +113°F), except for the Korean market: +10°C to +45°C (+50°F to +113°F)
External power operation	AC adapter 90–260 V AC, 50/60 Hz or 12 V from a vehicle (cable with a standard plug, optional)
Power management	Automatic power-off functionality, user configurable between 5 minutes, 20 minutes, and no automatic shutdown
Environmental data	
Operating temperature range	–15°C to +50°C (+5°F to +122°F)
Storage temperature range	–40 to +70°C (–40 to +158°F)
Humidity (operating and storage)	IEC 60068-2-30 / 24 hours, 95% relative humidity, 25–40°C (77–104°F) / 2 cycles
EMC	<ul style="list-style-type: none"> ETSI EN 301 489-1 (radio) ETSI EN 301 489-17 EN 61000-6-2 (Immunity) EN 61000-6-3 (Emission) FCC 47 CFR Part 15 Class B (Emission) ICES-003
Radio spectrum	<ul style="list-style-type: none"> ETSI EN 300 328 FCC Part 15.247 RSS-247 Issue 2
Encapsulation	IP 54 (IEC 60529)
Shock	25 g (IEC 60068-2-29)
Vibration	2 g (IEC 60068-2-6)
Safety	EN/UL/CSA/PSE 60950-1
Ergonomics	The viewfinder plus the 120° rotating optical block allow you to point the camera in multiple directions while maintaining a comfortable position
Physical data	
Weight	2.1 kg (4.6 lb.)
Camera size, excl. lens (L × W × H)	167.2 mm × 204.5 mm × 188.3 mm (6.6 in. × 8.0 in. × 7.4 in.)
Tripod mounting	UNC ¼"-20
Housing material	Magnesium

Warranty information	
Warranty	<ul style="list-style-type: none"> • 2 years parts and labor coverage on the camera • 5 years coverage on the battery • 10 years coverage on the detector – the most vital part of the whole camera
Shipping information	
List of contents	<ul style="list-style-type: none"> • Infrared camera with lens • Battery (2 ea.) • Battery charger • Bluetooth headset • Calibration certificate • FLIR Tools+ license card • Hard transport case • HDMI-HDMI cable • Lens cap • Memory card • Neck strap • Power supply, including multi-plugs • Printed documentation • USB cable, Std A to Micro-B
EAN-13	7332558010273
UPC-12	845188010911
Country of origin	Sweden

Supplies & accessories:

- T199064; IR lens f=36mm (28°) with case
- T199066; IR lens f=21.2mm (45°) with case
- T199077; IR lens f=83.4mm (12°) with case
- T910814; Power supply, incl. multi plugs
- T198126; Battery charger, incl. power supply with multi plugs T6xx
- T199364ACC; Battery Li-ion 3.65 V, 8.5 Ah, 32 Wh
- T911650ACC; Memory card SD Card 8 GB
- T198509; Cigarette lighter adapter kit, 12 VDC, 1.2 m/3.9 ft.
- T910930ACC; HDMI type C to DVI cable 1.5 m
- T910891ACC; HDMI type C to HDMI type A cable 1.5 m
- T198497; Large eyecup
- T197771ACC; Bluetooth Headset
- T911093; Tool belt
- T198533; USB cable Std A <-> Micro B
- T198586; FLIR Reporter Professional (license only)
- T198584; FLIR Tools
- T198583; FLIR Tools+ (download card incl. license key)
- DSW-10000; FLIR IR Camera Player
- APP-10002; FLIR Tools Mobile (Android Application)
- APP-10003; FLIR Tools Mobile (iPad/iPhone Application)
- APP-10004; FLIR Tools (MacOS Application)
- T199233; FLIR Atlas SDK for .NET
- T199234; FLIR Atlas SDK for MATLAB

30.8 FLIR T1020 28°

P/N: 72501-0102

Rev.: 46140

General description	
The FLIR T1020 is designed for the expert requiring the highest performance and the latest technology available. The camera combines excellent ergonomics and feature-rich flexibility with superior image quality at an infrared resolution of 1024 × 768 pixels.	
Benefits:	
<ul style="list-style-type: none"> • Flexible and feature rich: A wide variety of measuring and analysis functions make the FLIR T1020 flexible for your every need. Two programmable buttons provide easy access to favorite functions. • Highest performance with the latest technology: The FLIR T1020 is equipped with the innovative Multi Spectral Dynamic Imaging (MSX) feature, which produces an image richer in detail than ever before. With its continuous autofocus, the FLIR T1020 is a fully automatic infrared camera. • Support for UltraMax: When enabling UltraMax in the camera, the resolution of images can be substantially enhanced when importing the images into FLIR Tools. 	
Imaging and optical data	
IR resolution	1024 × 768 pixels
MSX resolution	1024 × 768 pixels
UltraMax	Yes
Thermal sensitivity/NETD	<20 mK @ +30°C (+86°F)
Field of view (FOV)	28° × 21°
Minimum IR focus distance	0.4 m (1.32 ft.)
Minimum IR–visual alignment distance	0.4 m (1.32 ft.)
Focal length	36 mm (1.42 in.)
Spatial resolution (IFOV)	0.47 mrad
Lens identification	Automatic
F-number	1.15
Image frequency	30 Hz
Focus	One shot or manual
Digital zoom	1–8× continuous
Digital image enhancement	Adaptive digital noise reduction
Detector data	
Detector type	Focal plane array (FPA), uncooled microbolometer
Spectral range	7.5–14 μm
Detector pitch	17 μm
Image presentation	
Display	Built-in touch screen, 4.3 in. wide screen LCD, 800 × 480 pixels
Display type	Capacitive touch screen
Auto orientation	Automatic landscape or portrait
Viewfinder	Built-in 800 × 480 pixels
Automatic image adjustment	Continuous, histogram based
Automatic image adjustment, type	Standard or histogram based on the image content
Manual image adjustment	Linear based, possible to adjust level/span/max./min.

Image presentation modes	
Image modes	Thermal, thermal MSX, picture in picture, digital camera
Infrared image	Full color infrared image
Visual image	Full color visual image
Multi Spectral Dynamic Imaging (MSX)	Thermal image with enhanced detail presentation
Picture in Picture	Resizable and movable infrared area on the visual image
Gallery	<ul style="list-style-type: none"> Review thumbnail/full image on the camera Edit measurements/palettes/image modes on the camera

Measurement		
Object temperature range		Accuracy
-40 to +150°C (-40 to +302°F)	-40 to +5°C (-40 to +41°F)	±2°C (±3.6°F)
	+5 to +100°C (+41 to +212°F)	±1°C (±1.8°F)
	+100 to +150°C (+212 to +302°F)	±1%
0 to +650°C (+32 to +1202°F)	0 to +100°C (+32 to +212°F)	±2°C (±3.6°F)
	+100 to +650°C (+212 to +1202°F)	±2%
+300 to +2000°C (+572 to +3632°F)	+300 to +2000°C (+572 to +3632°F)	±2%

**NOTE**

For HSI use, above 30 Hz frame rate, the typical accuracy will be ±2.5°C (±4.5°F), or 2.5% of reading @ 25°C (77°F).

Measurement analysis	
Spotmeter	10
Area	5 + 5 areas (boxes and circles) with max./min./average
Profile	1 line profile with max./min. temperature
Automatic hot/cold detection	Auto hot or cold spotmeter markers within the area and profile
Measurement presets	No measurements, Center spot, Hot spot, Cold spot, User preset 1, User preset 2
User presets	The user can select and combine measurements from any number of spots/boxes/circles/profiles/delta
Difference temperature	Delta temperature between the measurement functions and the reference temperature
Reference temperature	Manually set using the difference temperature
Atmospheric transmission correction	Automatic, based on the inputs for distance, atmospheric temperature, and relative humidity
Optics transmission correction	Automatic, based on signals from internal sensors
Emissivity correction	Variable from 0.01 to 1.0 or selected from the materials list
Reflected apparent temperature correction	Automatic, based on the input of the reflected temperature
External optics/windows correction	Automatic, based on the inputs of the window transmission and temperature

Measurement analysis	
Measurement corrections	Emissivity, reflected temperature, relative humidity, atmospheric temperature, object distance, external infrared window compensation
Colors (palettes)	Iron, Rainbow, Rainbow HC, White hot, Black hot, Arctic, Lava
Alarm	
Color alarm (isotherm)	<ul style="list-style-type: none"> • Above • Below • Interval • Condensation (moisture/humidity/dewpoint) • Insulation
Measurement function alarm	Audible/visual alarms (above/below) on any selected measurement function
Set-up	
Set-up commands	Define user presets, Save options, Programmable button, Reset options, Set up camera, Wi-Fi, GPS & compass, Bluetooth, Language, Time & units, Camera information
Languages	Arabic, Czech, Danish, Dutch, English, Finnish, French, German, Greek, Hungarian, Italian, Japanese, Korean, Norwegian, Polish, Portuguese, Russian, simplified Chinese, Swedish, traditional Chinese, Turkish
Service functions	
Camera software update	Use PC software FLIR Tools
Storage of images	
Image storage	Standard JPEG, including digital image and measurement data, on a memory card
Storage media	Removable media SD or SDHC card. Class 10 or better recommended
Image storage mode	<ul style="list-style-type: none"> • Simultaneous storage of thermal and digital images in the same JPEG file • Option to store a digital photo as a separate JPEG file
Time lapse	15 seconds to 24 hours
File formats	<ul style="list-style-type: none"> • Standard JPEG, measurement data included • CSQ, measurement data included
File formats, visual	Standard JPEG, automatically associated with the corresponding thermal image
Image annotations	
Voice	60 seconds (via Bluetooth) stored with the image
Text	Add table, select between predefined templates
Image description	Add short note (stored in the JPEG exif tag)
Sketch	<ul style="list-style-type: none"> • Draw on the thermal/digital image or add predefined stamps • Separate PC software with extensive report generation
METERLiNK	Wireless connection (Bluetooth) to: FLIR meters with METERLiNK

Geographic Information System	
GPS	Location data automatically added to every image from the built-in GPS
Compass	Camera direction automatically added to every image
Video recording in camera	
Radiometric IR-video recording	Real-time radiometric recording (RTRR) to the memory card
Non-radiometric IR-video recording	H.264 to the memory card
Visual video recording	H.264 to the memory card
Video streaming	
Radiometric IR-video streaming	Real-time radiometric streaming (RTRS) via USB
Non-radiometric IR-video streaming	<ul style="list-style-type: none"> • H.264 video using Wi-Fi • H.264 video using USB
Visual video streaming	<ul style="list-style-type: none"> • H.264 video using Wi-Fi • H.264 video using USB
Digital camera	
Built-in digital camera	5 Mpixel with LED light
Digital camera	Field of view adapts to the infrared lens
Video lamp	Built-in LED light
Laser pointer	
Laser	Activated by a dedicated button
Laser alignment	Position is automatically displayed on the infrared image
Laser classification	Class 2
Laser type	Semiconductor AlGaInP diode laser, 1 mW, 635 nm (red)
Data communication interfaces	
Interfaces	USB Micro-B, Bluetooth, Wi-Fi, HDMI
METERLiNK/Bluetooth	Communication with headset and external sensors
Wi-Fi	Infrastructure (network) or AP
SD Card	One card slot for removable SD memory cards
Audio	Microphone headset via Bluetooth for the voice annotation of images
USB	
USB	USB Micro-B: data transfer to and from a PC, uncompressed colorized video
USB, standard	<ul style="list-style-type: none"> • USB 2.0 High Speed • USB Micro-B connector
Video	
Video out	<ul style="list-style-type: none"> • HDMI 640 × 480 • HDMI 1280 × 720 • DVI 640 × 480 • DVI 800 × 600
Video, connector type	HDMI type C

Radio	
Wi-Fi	<ul style="list-style-type: none"> • Standard: 802.11 b/g/n • Frequency range: 2412–2462 MHz • Max. output power: 15 dBm
METERLiNK/Bluetooth	Frequency range: 2402–2480 MHz, supports 2.1 and 4.0
Antenna	Internal
Power system	
Battery type	Rechargeable Li ion battery
Battery operating time	>2.5 hours at 25°C (+68°F) and typical use
Charging system	In camera (AC adapter or 12 V from a vehicle) or two-bay charger
Charging time	2.5 hours to 90% capacity, charging status indicated by LEDs
Charging temperature	0°C to +45°C (+32°F to +113°F), except for the Korean market: +10°C to +45°C (+50°F to +113°F)
External power operation	AC adapter 90–260 V AC, 50/60 Hz or 12 V from a vehicle (cable with a standard plug, optional)
Power management	Automatic power-off functionality, user configurable between 5 minutes, 20 minutes, and no automatic shutdown
Environmental data	
Operating temperature range	–15°C to +50°C (+5°F to +122°F)
Storage temperature range	–40 to +70°C (–40 to +158°F)
Humidity (operating and storage)	IEC 60068-2-30 / 24 hours, 95% relative humidity, 25–40°C (77–104°F) / 2 cycles
EMC	<ul style="list-style-type: none"> • ETSI EN 301 489-1 (radio) • ETSI EN 301 489-17 • EN 61000-6-2 (Immunity) • EN 61000-6-3 (Emission) • FCC 47 CFR Part 15 Class B (Emission) • ICES-003
Radio spectrum	<ul style="list-style-type: none"> • ETSI EN 300 328 • FCC Part 15.247 • RSS-247 Issue 2
Encapsulation	IP 54 (IEC 60529)
Shock	25 g (IEC 60068-2-29)
Vibration	2 g (IEC 60068-2-6)
Safety	EN/UL/CSA/PSE 60950-1
Ergonomics	The viewfinder plus the 120° rotating optical block allow you to point the camera in multiple directions while maintaining a comfortable position
Physical data	
Weight	1.9 kg (4.3 lb.)
Camera size, excl. lens (L × W × H)	167.2 mm × 204.5 mm × 188.3 mm (6.6 in. × 8.0 in. × 7.4 in.)
Tripod mounting	UNC ¼"-20
Housing material	Magnesium

Warranty information	
Warranty	<ul style="list-style-type: none"> • 2 years parts and labor coverage on the camera • 5 years coverage on the battery • 10 years coverage on the detector – the most vital part of the whole camera
Shipping information	
List of contents	<ul style="list-style-type: none"> • Infrared camera with lens • Battery (2 ea.) • Battery charger • Bluetooth headset • Calibration certificate • FLIR Tools+ license card • Hard transport case • HDMI-HDMI cable • Lens cap • Memory card • Neck strap • Power supply, including multi-plugs • Printed documentation • USB cable, Std A to Micro-B
EAN-13	7332558010280
UPC-12	845188010928
Country of origin	Sweden

Supplies & accessories:

- T199064; IR lens f=36mm (28°) with case
- T199065; Close-up lens 3x (51 micron) with case
- T199066; IR lens f=21.2mm (45°) with case
- T199077; IR lens f=83.4mm (12°) with case
- T910814; Power supply, incl. multi plugs
- T198126; Battery charger, incl. power supply with multi plugs T6xx
- T199364ACC; Battery Li-ion 3.65 V, 8.5 Ah, 32 Wh
- T911650ACC; Memory card SD Card 8 GB
- T198509; Cigarette lighter adapter kit, 12 VDC, 1.2 m/3.9 ft.
- T910930ACC; HDMI type C to DVI cable 1.5 m
- T910891ACC; HDMI type C to HDMI type A cable 1.5 m
- T198497; Large eyecup
- T197771ACC; Bluetooth Headset
- T911093; Tool belt
- T198533; USB cable Std A <-> Micro B
- T198586; FLIR Reporter Professional (license only)
- T198584; FLIR Tools
- T198583; FLIR Tools+ (download card incl. license key)
- DSW-10000; FLIR IR Camera Player
- APP-10002; FLIR Tools Mobile (Android Application)
- APP-10003; FLIR Tools Mobile (iPad/iPhone Application)
- APP-10004; FLIR Tools (MacOS Application)
- T199233; FLIR Atlas SDK for .NET
- T199234; FLIR Atlas SDK for MATLAB

30.9 FLIR T1020 45°

P/N: 72501-0103

Rev.: 46143

General description	
The FLIR T1020 is designed for the expert requiring the highest performance and the latest technology available. The camera combines excellent ergonomics and feature-rich flexibility with superior image quality at an infrared resolution of 1024 × 768 pixels.	
Benefits:	
<ul style="list-style-type: none"> • Flexible and feature rich: A wide variety of measuring and analysis functions make the FLIR T1020 flexible for your every need. Two programmable buttons provide easy access to favorite functions. • Highest performance with the latest technology: The FLIR T1020 is equipped with the innovative Multi Spectral Dynamic Imaging (MSX) feature, which produces an image richer in detail than ever before. With its continuous autofocus, the FLIR T1020 is a fully automatic infrared camera. • Support for UltraMax: When enabling UltraMax in the camera, the resolution of images can be substantially enhanced when importing the images into FLIR Tools. 	
Imaging and optical data	
IR resolution	1024 × 768 pixels
MSX resolution	1024 × 768 pixels
UltraMax	Yes
Thermal sensitivity/NETD	<20 mK @ +30°C (+86°F)
Field of view (FOV)	45° × 34°
Minimum IR focus distance	0.2 m (0.66 ft.)
Minimum IR–visual alignment distance	0.5 m (1.64 ft.)
Focal length	21.2 mm (0.83 in.)
Spatial resolution (IFOV)	0.80 mrad
Lens identification	Automatic
F-number	1.1
Image frequency	30 Hz
Focus	One shot or manual
Digital zoom	1–8× continuous
Digital image enhancement	Adaptive digital noise reduction
Detector data	
Detector type	Focal plane array (FPA), uncooled microbolometer
Spectral range	7.5–14 μm
Detector pitch	17 μm
Image presentation	
Display	Built-in touch screen, 4.3 in. wide screen LCD, 800 × 480 pixels
Display type	Capacitive touch screen
Auto orientation	Automatic landscape or portrait
Viewfinder	Built-in 800 × 480 pixels
Automatic image adjustment	Continuous, histogram based
Automatic image adjustment, type	Standard or histogram based on the image content
Manual image adjustment	Linear based, possible to adjust level/span/max./min.

Image presentation modes	
Image modes	Thermal, thermal MSX, picture in picture, digital camera
Infrared image	Full color infrared image
Visual image	Full color visual image
Multi Spectral Dynamic Imaging (MSX)	Thermal image with enhanced detail presentation
Picture in Picture	Resizable and movable infrared area on the visual image
Gallery	<ul style="list-style-type: none"> Review thumbnail/full image on the camera Edit measurements/palettes/image modes on the camera

Measurement		
Object temperature range		Accuracy
-40 to +150°C (-40 to +302°F)	-40 to +5°C (-40 to +41°F)	±2°C (±3.6°F)
	+5 to +100°C (+41 to +212°F)	±1°C (±1.8°F)
	+100 to +150°C (+212 to +302°F)	±1%
0 to +650°C (+32 to +1202°F)	0 to +100°C (+32 to +212°F)	±2°C (±3.6°F)
	+100 to +650°C (+212 to +1202°F)	±2%
+300 to +2000°C (+572 to +3632°F)	+300 to +2000°C (+572 to +3632°F)	±2%

**NOTE**

For HSI use, above 30 Hz frame rate, the typical accuracy will be ±2.5°C (±4.5°F), or 2.5% of reading @ 25°C (77°F).

Measurement analysis	
Spotmeter	10
Area	5 + 5 areas (boxes and circles) with max./min./average
Profile	1 line profile with max./min. temperature
Automatic hot/cold detection	Auto hot or cold spotmeter markers within the area and profile
Measurement presets	No measurements, Center spot, Hot spot, Cold spot, User preset 1, User preset 2
User presets	The user can select and combine measurements from any number of spots/boxes/circles/profiles/delta
Difference temperature	Delta temperature between the measurement functions and the reference temperature
Reference temperature	Manually set using the difference temperature
Atmospheric transmission correction	Automatic, based on the inputs for distance, atmospheric temperature, and relative humidity
Optics transmission correction	Automatic, based on signals from internal sensors
Emissivity correction	Variable from 0.01 to 1.0 or selected from the materials list
Reflected apparent temperature correction	Automatic, based on the input of the reflected temperature
External optics/windows correction	Automatic, based on the inputs of the window transmission and temperature

Measurement analysis	
Measurement corrections	Emissivity, reflected temperature, relative humidity, atmospheric temperature, object distance, external infrared window compensation
Colors (palettes)	Iron, Rainbow, Rainbow HC, White hot, Black hot, Arctic, Lava
Alarm	
Color alarm (isotherm)	<ul style="list-style-type: none"> • Above • Below • Interval • Condensation (moisture/humidity/dewpoint) • Insulation
Measurement function alarm	Audible/visual alarms (above/below) on any selected measurement function
Set-up	
Set-up commands	Define user presets, Save options, Programmable button, Reset options, Set up camera, Wi-Fi, GPS & compass, Bluetooth, Language, Time & units, Camera information
Languages	Arabic, Czech, Danish, Dutch, English, Finnish, French, German, Greek, Hungarian, Italian, Japanese, Korean, Norwegian, Polish, Portuguese, Russian, simplified Chinese, Swedish, traditional Chinese, Turkish
Service functions	
Camera software update	Use PC software FLIR Tools
Storage of images	
Image storage	Standard JPEG, including digital image and measurement data, on a memory card
Storage media	Removable media SD or SDHC card. Class 10 or better recommended
Image storage mode	<ul style="list-style-type: none"> • Simultaneous storage of thermal and digital images in the same JPEG file • Option to store a digital photo as a separate JPEG file
Time lapse	15 seconds to 24 hours
File formats	<ul style="list-style-type: none"> • Standard JPEG, measurement data included • CSQ, measurement data included
File formats, visual	Standard JPEG, automatically associated with the corresponding thermal image
Image annotations	
Voice	60 seconds (via Bluetooth) stored with the image
Text	Add table, select between predefined templates
Image description	Add short note (stored in the JPEG exif tag)
Sketch	<ul style="list-style-type: none"> • Draw on the thermal/digital image or add predefined stamps • Separate PC software with extensive report generation
METERLiNK	Wireless connection (Bluetooth) to: FLIR meters with METERLiNK

Geographic Information System	
GPS	Location data automatically added to every image from the built-in GPS
Compass	Camera direction automatically added to every image
Video recording in camera	
Radiometric IR-video recording	Real-time radiometric recording (RTRR) to the memory card
Non-radiometric IR-video recording	H.264 to the memory card
Visual video recording	H.264 to the memory card
Video streaming	
Radiometric IR-video streaming	Real-time radiometric streaming (RTRS) via USB
Non-radiometric IR-video streaming	<ul style="list-style-type: none"> • H.264 video using Wi-Fi • H.264 video using USB
Visual video streaming	<ul style="list-style-type: none"> • H.264 video using Wi-Fi • H.264 video using USB
Digital camera	
Built-in digital camera	5 Mpixel with LED light
Digital camera	Field of view adapts to the infrared lens
Video lamp	Built-in LED light
Laser pointer	
Laser	Activated by a dedicated button
Laser alignment	Position is automatically displayed on the infrared image
Laser classification	Class 2
Laser type	Semiconductor AlGaInP diode laser, 1 mW, 635 nm (red)
Data communication interfaces	
Interfaces	USB Micro-B, Bluetooth, Wi-Fi, HDMI
METERLiNK/Bluetooth	Communication with headset and external sensors
Wi-Fi	Infrastructure (network) or AP
SD Card	One card slot for removable SD memory cards
Audio	Microphone headset via Bluetooth for the voice annotation of images
USB	
USB	USB Micro-B: data transfer to and from a PC, uncompressed colorized video
USB, standard	<ul style="list-style-type: none"> • USB 2.0 High Speed • USB Micro-B connector
Video	
Video out	<ul style="list-style-type: none"> • HDMI 640 × 480 • HDMI 1280 × 720 • DVI 640 × 480 • DVI 800 × 600
Video, connector type	HDMI type C

Radio	
Wi-Fi	<ul style="list-style-type: none"> Standard: 802.11 b/g/n Frequency range: 2412–2462 MHz Max. output power: 15 dBm
METERLiNK/Bluetooth	Frequency range: 2402–2480 MHz, supports 2.1 and 4.0
Antenna	Internal
Power system	
Battery type	Rechargeable Li ion battery
Battery operating time	>2.5 hours at 25°C (+68°F) and typical use
Charging system	In camera (AC adapter or 12 V from a vehicle) or two-bay charger
Charging time	2.5 hours to 90% capacity, charging status indicated by LEDs
Charging temperature	0°C to +45°C (+32°F to +113°F), except for the Korean market: +10°C to +45°C (+50°F to +113°F)
External power operation	AC adapter 90–260 V AC, 50/60 Hz or 12 V from a vehicle (cable with a standard plug, optional)
Power management	Automatic power-off functionality, user configurable between 5 minutes, 20 minutes, and no automatic shutdown
Environmental data	
Operating temperature range	–15°C to +50°C (+5°F to +122°F)
Storage temperature range	–40 to +70°C (–40 to +158°F)
Humidity (operating and storage)	IEC 60068-2-30 / 24 hours, 95% relative humidity, 25–40°C (77–104°F) / 2 cycles
EMC	<ul style="list-style-type: none"> ETSI EN 301 489-1 (radio) ETSI EN 301 489-17 EN 61000-6-2 (Immunity) EN 61000-6-3 (Emission) FCC 47 CFR Part 15 Class B (Emission) ICES-003
Radio spectrum	<ul style="list-style-type: none"> ETSI EN 300 328 FCC Part 15.247 RSS-247 Issue 2
Encapsulation	IP 54 (IEC 60529)
Shock	25 g (IEC 60068-2-29)
Vibration	2 g (IEC 60068-2-6)
Safety	EN/UL/CSA/PSE 60950-1
Ergonomics	The viewfinder plus the 120° rotating optical block allow you to point the camera in multiple directions while maintaining a comfortable position
Physical data	
Weight	2.0 kg (4.3 lb.)
Camera size, excl. lens (L × W × H)	167.2 mm × 204.5 mm × 188.3 mm (6.6 in. × 8.0 in. × 7.4 in.)
Tripod mounting	UNC ¼"-20
Housing material	Magnesium

Warranty information	
Warranty	<ul style="list-style-type: none"> • 2 years parts and labor coverage on the camera • 5 years coverage on the battery • 10 years coverage on the detector – the most vital part of the whole camera
Shipping information	
List of contents	<ul style="list-style-type: none"> • Infrared camera with lens • Battery (2 ea.) • Battery charger • Bluetooth headset • Calibration certificate • FLIR Tools+ license card • Hard transport case • HDMI-HDMI cable • Lens cap • Memory card • Neck strap • Power supply, including multi-plugs • Printed documentation • USB cable, Std A to Micro-B
EAN-13	7332558010297
UPC-12	845188010935
Country of origin	Sweden

Supplies & accessories:

- T199064; IR lens f=36mm (28°) with case
- T199066; IR lens f=21.2mm (45°) with case
- T199077; IR lens f=83.4mm (12°) with case
- T910814; Power supply, incl. multi plugs
- T198126; Battery charger, incl. power supply with multi plugs T6xx
- T199364ACC; Battery Li-ion 3.65 V, 8.5 Ah, 32 Wh
- T911650ACC; Memory card SD Card 8 GB
- T198509; Cigarette lighter adapter kit, 12 VDC, 1.2 m/3.9 ft.
- T910930ACC; HDMI type C to DVI cable 1.5 m
- T910891ACC; HDMI type C to HDMI type A cable 1.5 m
- T198497; Large eyecup
- T197771ACC; Bluetooth Headset
- T911093; Tool belt
- T198533; USB cable Std A <-> Micro B
- T198586; FLIR Reporter Professional (license only)
- T198584; FLIR Tools
- T198583; FLIR Tools+ (download card incl. license key)
- DSW-10000; FLIR IR Camera Player
- APP-10002; FLIR Tools Mobile (Android Application)
- APP-10003; FLIR Tools Mobile (iPad/iPhone Application)
- APP-10004; FLIR Tools (MacOS Application)
- T199233; FLIR Atlas SDK for .NET
- T199234; FLIR Atlas SDK for MATLAB

30.10 FLIR T1020 28° and 12°

P/N: 72501-0104

Rev.: 46138

General description	
The FLIR T1020 is designed for the expert requiring the highest performance and the latest technology available. The camera combines excellent ergonomics and feature-rich flexibility with superior image quality at an infrared resolution of 1024 × 768 pixels.	
Benefits:	
<ul style="list-style-type: none"> • Flexible and feature rich: A wide variety of measuring and analysis functions make the FLIR T1020 flexible for your every need. Two programmable buttons provide easy access to favorite functions. • Highest performance with the latest technology: The FLIR T1020 is equipped with the innovative Multi Spectral Dynamic Imaging (MSX) feature, which produces an image richer in detail than ever before. With its continuous autofocus, the FLIR T1020 is a fully automatic infrared camera. • Support for UltraMax: When enabling UltraMax in the camera, the resolution of images can be substantially enhanced when importing the images into FLIR Tools. 	
Imaging and optical data	
IR resolution	1024 × 768 pixels
MSX resolution	1024 × 768 pixels
UltraMax	Yes
Thermal sensitivity/NETD	<20 mK @ +30°C (+86°F)
Field of view (FOV)	28° × 21°
Minimum IR focus distance	0.4 m (1.32 ft.)
Minimum IR–visual alignment distance	0.4 m (1.32 ft.)
Focal length	36 mm (1.42 in.)
Spatial resolution (IFOV)	0.47 mrad
Lens identification	Automatic
F-number	1.15
Image frequency	30 Hz
Focus	One shot or manual
Digital zoom	1–8× continuous
Digital image enhancement	Adaptive digital noise reduction
Detector data	
Detector type	Focal plane array (FPA), uncooled microbolometer
Spectral range	7.5–14 μm
Detector pitch	17 μm
Image presentation	
Display	Built-in touch screen, 4.3 in. wide screen LCD, 800 × 480 pixels
Display type	Capacitive touch screen
Auto orientation	Automatic landscape or portrait
Viewfinder	Built-in 800 × 480 pixels
Automatic image adjustment	Continuous, histogram based
Automatic image adjustment, type	Standard or histogram based on the image content
Manual image adjustment	Linear based, possible to adjust level/span/max./min.

Image presentation modes	
Image modes	Thermal, thermal MSX, picture in picture, digital camera
Infrared image	Full color infrared image
Visual image	Full color visual image
Multi Spectral Dynamic Imaging (MSX)	Thermal image with enhanced detail presentation
Picture in Picture	Resizable and movable infrared area on the visual image
Gallery	<ul style="list-style-type: none"> Review thumbnail/full image on the camera Edit measurements/palettes/image modes on the camera

Measurement		
Object temperature range		Accuracy
-40 to +150°C (-40 to +302°F)	-40 to +5°C (-40 to +41°F)	±2°C (±3.6°F)
	+5 to +100°C (+41 to +212°F)	±1°C (±1.8°F)
	+100 to +150°C (+212 to +302°F)	±1%
0 to +650°C (+32 to +1202°F)	0 to +100°C (+32 to +212°F)	±2°C (±3.6°F)
	+100 to +650°C (+212 to +1202°F)	±2%
+300 to +2000°C (+572 to +3632°F)	+300 to +2000°C (+572 to +3632°F)	±2%

**NOTE**

For HSI use, above 30 Hz frame rate, the typical accuracy will be ±2.5°C (±4.5°F), or 2.5% of reading @ 25°C (77°F).

Measurement analysis	
Spotmeter	10
Area	5 + 5 areas (boxes and circles) with max./min./average
Profile	1 line profile with max./min. temperature
Automatic hot/cold detection	Auto hot or cold spotmeter markers within the area and profile
Measurement presets	No measurements, Center spot, Hot spot, Cold spot, User preset 1, User preset 2
User presets	The user can select and combine measurements from any number of spots/boxes/circles/profiles/delta
Difference temperature	Delta temperature between the measurement functions and the reference temperature
Reference temperature	Manually set using the difference temperature
Atmospheric transmission correction	Automatic, based on the inputs for distance, atmospheric temperature, and relative humidity
Optics transmission correction	Automatic, based on signals from internal sensors
Emissivity correction	Variable from 0.01 to 1.0 or selected from the materials list
Reflected apparent temperature correction	Automatic, based on the input of the reflected temperature
External optics/windows correction	Automatic, based on the inputs of the window transmission and temperature

Measurement analysis	
Measurement corrections	Emissivity, reflected temperature, relative humidity, atmospheric temperature, object distance, external infrared window compensation
Colors (palettes)	Iron, Rainbow, Rainbow HC, White hot, Black hot, Arctic, Lava
Alarm	
Color alarm (isotherm)	<ul style="list-style-type: none"> • Above • Below • Interval • Condensation (moisture/humidity/dewpoint) • Insulation
Measurement function alarm	Audible/visual alarms (above/below) on any selected measurement function
Set-up	
Set-up commands	Define user presets, Save options, Programmable button, Reset options, Set up camera, Wi-Fi, GPS & compass, Bluetooth, Language, Time & units, Camera information
Languages	Arabic, Czech, Danish, Dutch, English, Finnish, French, German, Greek, Hungarian, Italian, Japanese, Korean, Norwegian, Polish, Portuguese, Russian, simplified Chinese, Swedish, traditional Chinese, Turkish
Service functions	
Camera software update	Use PC software FLIR Tools
Storage of images	
Image storage	Standard JPEG, including digital image and measurement data, on a memory card
Storage media	Removable media SD or SDHC card. Class 10 or better recommended
Image storage mode	<ul style="list-style-type: none"> • Simultaneous storage of thermal and digital images in the same JPEG file • Option to store a digital photo as a separate JPEG file
Time lapse	15 seconds to 24 hours
File formats	<ul style="list-style-type: none"> • Standard JPEG, measurement data included • CSQ, measurement data included
File formats, visual	Standard JPEG, automatically associated with the corresponding thermal image
Image annotations	
Voice	60 seconds (via Bluetooth) stored with the image
Text	Add table, select between predefined templates
Image description	Add short note (stored in the JPEG exif tag)
Sketch	<ul style="list-style-type: none"> • Draw on the thermal/digital image or add predefined stamps • Separate PC software with extensive report generation
METERLiNK	Wireless connection (Bluetooth) to: FLIR meters with METERLiNK

Geographic Information System	
GPS	Location data automatically added to every image from the built-in GPS
Compass	Camera direction automatically added to every image
Video recording in camera	
Radiometric IR-video recording	Real-time radiometric recording (RTRR) to the memory card
Non-radiometric IR-video recording	H.264 to the memory card
Visual video recording	H.264 to the memory card
Video streaming	
Radiometric IR-video streaming	Real-time radiometric streaming (RTRS) via USB
Non-radiometric IR-video streaming	<ul style="list-style-type: none"> • H.264 video using Wi-Fi • H.264 video using USB
Visual video streaming	<ul style="list-style-type: none"> • H.264 video using Wi-Fi • H.264 video using USB
Digital camera	
Built-in digital camera	5 Mpixel with LED light
Digital camera	Field of view adapts to the infrared lens
Video lamp	Built-in LED light
Laser pointer	
Laser	Activated by a dedicated button
Laser alignment	Position is automatically displayed on the infrared image
Laser classification	Class 2
Laser type	Semiconductor AlGaInP diode laser, 1 mW, 635 nm (red)
Data communication interfaces	
Interfaces	USB Micro-B, Bluetooth, Wi-Fi, HDMI
METERLiNK/Bluetooth	Communication with headset and external sensors
Wi-Fi	Infrastructure (network) or AP
SD Card	One card slot for removable SD memory cards
Audio	Microphone headset via Bluetooth for the voice annotation of images
USB	
USB	USB Micro-B: data transfer to and from a PC, uncompressed colorized video
USB, standard	<ul style="list-style-type: none"> • USB 2.0 High Speed • USB Micro-B connector
Video	
Video out	<ul style="list-style-type: none"> • HDMI 640 × 480 • HDMI 1280 × 720 • DVI 640 × 480 • DVI 800 × 600
Video, connector type	HDMI type C

Radio	
Wi-Fi	<ul style="list-style-type: none"> • Standard: 802.11 b/g/n • Frequency range: 2412–2462 MHz • Max. output power: 15 dBm
METERLiNK/Bluetooth	Frequency range: 2402–2480 MHz, supports 2.1 and 4.0
Antenna	Internal
Power system	
Battery type	Rechargeable Li ion battery
Battery operating time	>2.5 hours at 25°C (+68°F) and typical use
Charging system	In camera (AC adapter or 12 V from a vehicle) or two-bay charger
Charging time	2.5 hours to 90% capacity, charging status indicated by LEDs
Charging temperature	0°C to +45°C (+32°F to +113°F), except for the Korean market: +10°C to +45°C (+50°F to +113°F)
External power operation	AC adapter 90–260 V AC, 50/60 Hz or 12 V from a vehicle (cable with a standard plug, optional)
Power management	Automatic power-off functionality, user configurable between 5 minutes, 20 minutes, and no automatic shutdown
Environmental data	
Operating temperature range	–15°C to +50°C (+5°F to +122°F)
Storage temperature range	–40 to +70°C (–40 to +158°F)
Humidity (operating and storage)	IEC 60068-2-30 / 24 hours, 95% relative humidity, 25–40°C (77–104°F) / 2 cycles
EMC	<ul style="list-style-type: none"> • ETSI EN 301 489-1 (radio) • ETSI EN 301 489-17 • EN 61000-6-2 (Immunity) • EN 61000-6-3 (Emission) • FCC 47 CFR Part 15 Class B (Emission) • ICES-003
Radio spectrum	<ul style="list-style-type: none"> • ETSI EN 300 328 • FCC Part 15.247 • RSS-247 Issue 2
Encapsulation	IP 54 (IEC 60529)
Shock	25 g (IEC 60068-2-29)
Vibration	2 g (IEC 60068-2-6)
Safety	EN/UL/CSA/PSE 60950-1
Ergonomics	The viewfinder plus the 120° rotating optical block allow you to point the camera in multiple directions while maintaining a comfortable position
Physical data	
Weight	1.9 kg (4.3 lb.)
Camera size, excl. lens (L × W × H)	167.2 mm × 204.5 mm × 188.3 mm (6.6 in. × 8.0 in. × 7.4 in.)
Tripod mounting	UNC ¼"-20
Housing material	Magnesium

Warranty information	
Warranty	<ul style="list-style-type: none"> • 2 years parts and labor coverage on the camera • 5 years coverage on the battery • 10 years coverage on the detector – the most vital part of the whole camera
Shipping information	
Packaging, type	Cardboard box
List of contents	<ul style="list-style-type: none"> • Infrared camera with lens • Battery (2 ea.) • Battery charger • Bluetooth headset • Calibration certificate • FLIR Tools+ license card • Hard transport case • HDMI-HDMI cable • IR lens, 12° • Lens cap • Memory card • Neck strap • Power supply, including multi-plugs • Printed documentation • USB cable, Std A to Micro-B
Packaging, weight	7.2 kg (15.8 lb.)
Packaging, size	494 × 355 × 188 mm (19.4 × 14.0 × 7.4 in.)
EAN-13	7332558011287
UPC-12	845188012168
Country of origin	Sweden

Supplies & accessories:

- T199064; IR lens f=36mm (28°) with case
- T199065; Close-up lens 3x (51 micron) with case
- T199066; IR lens f=21.2mm (45°) with case
- T199077; IR lens f=83.4mm (12°) with case
- T910814; Power supply, incl. multi plugs
- T198126; Battery charger, incl. power supply with multi plugs T6xx
- T199364ACC; Battery Li-ion 3.65 V, 8.5 Ah, 32 Wh
- T911650ACC; Memory card SD Card 8 GB
- T198509; Cigarette lighter adapter kit, 12 VDC, 1.2 m/3.9 ft.
- T910930ACC; HDMI type C to DVI cable 1.5 m
- T910891ACC; HDMI type C to HDMI type A cable 1.5 m
- T198497; Large eyecup
- T197771ACC; Bluetooth Headset
- T911093; Tool belt
- T198533; USB cable Std A <-> Micro B
- T198586; FLIR Reporter Professional (license only)
- T198584; FLIR Tools
- T198583; FLIR Tools+ (download card incl. license key)
- DSW-10000; FLIR IR Camera Player
- APP-10002; FLIR Tools Mobile (Android Application)
- APP-10003; FLIR Tools Mobile (iPad/iPhone Application)
- APP-10004; FLIR Tools (MacOS Application)
- T199233; FLIR Atlas SDK for .NET
- T199234; FLIR Atlas SDK for MATLAB

30.11 FLIR T1020 28° and 45°

P/N: 72501-0105

Rev.: 46137

General description	
The FLIR T1020 is designed for the expert requiring the highest performance and the latest technology available. The camera combines excellent ergonomics and feature-rich flexibility with superior image quality at an infrared resolution of 1024 × 768 pixels.	
Benefits:	
<ul style="list-style-type: none"> • Flexible and feature rich: A wide variety of measuring and analysis functions make the FLIR T1020 flexible for your every need. Two programmable buttons provide easy access to favorite functions. • Highest performance with the latest technology: The FLIR T1020 is equipped with the innovative Multi Spectral Dynamic Imaging (MSX) feature, which produces an image richer in detail than ever before. With its continuous autofocus, the FLIR T1020 is a fully automatic infrared camera. • Support for UltraMax: When enabling UltraMax in the camera, the resolution of images can be substantially enhanced when importing the images into FLIR Tools. 	
Imaging and optical data	
IR resolution	1024 × 768 pixels
MSX resolution	1024 × 768 pixels
UltraMax	Yes
Thermal sensitivity/NETD	<20 mK @ +30°C (+86°F)
Field of view (FOV)	28° × 21°
Minimum IR focus distance	0.4 m (1.32 ft.)
Minimum IR–visual alignment distance	0.4 m (1.32 ft.)
Focal length	36 mm (1.42 in.)
Spatial resolution (IFOV)	0.47 mrad
Lens identification	Automatic
F-number	1.15
Image frequency	30 Hz
Focus	One shot or manual
Digital zoom	1–8× continuous
Digital image enhancement	Adaptive digital noise reduction
Detector data	
Detector type	Focal plane array (FPA), uncooled microbolometer
Spectral range	7.5–14 μm
Detector pitch	17 μm
Image presentation	
Display	Built-in touch screen, 4.3 in. wide screen LCD, 800 × 480 pixels
Display type	Capacitive touch screen
Auto orientation	Automatic landscape or portrait
Viewfinder	Built-in 800 × 480 pixels
Automatic image adjustment	Continuous, histogram based
Automatic image adjustment, type	Standard or histogram based on the image content
Manual image adjustment	Linear based, possible to adjust level/span/max./min.

Image presentation modes	
Image modes	Thermal, thermal MSX, picture in picture, digital camera
Infrared image	Full color infrared image
Visual image	Full color visual image
Multi Spectral Dynamic Imaging (MSX)	Thermal image with enhanced detail presentation
Picture in Picture	Resizable and movable infrared area on the visual image
Gallery	<ul style="list-style-type: none"> Review thumbnail/full image on the camera Edit measurements/palettes/image modes on the camera

Measurement		
Object temperature range		Accuracy
-40 to +150°C (-40 to +302°F)	-40 to +5°C (-40 to +41°F)	±2°C (±3.6°F)
	+5 to +100°C (+41 to +212°F)	±1°C (±1.8°F)
	+100 to +150°C (+212 to +302°F)	±1%
0 to +650°C (+32 to +1202°F)	0 to +100°C (+32 to +212°F)	±2°C (±3.6°F)
	+100 to +650°C (+212 to +1202°F)	±2%
+300 to +2000°C (+572 to +3632°F)	+300 to +2000°C (+572 to +3632°F)	±2%

**NOTE**

For HSI use, above 30 Hz frame rate, the typical accuracy will be ±2.5°C (±4.5°F), or 2.5% of reading @ 25°C (77°F).

Measurement analysis	
Spotmeter	10
Area	5 + 5 areas (boxes and circles) with max./min./average
Profile	1 line profile with max./min. temperature
Automatic hot/cold detection	Auto hot or cold spotmeter markers within the area and profile
Measurement presets	No measurements, Center spot, Hot spot, Cold spot, User preset 1, User preset 2
User presets	The user can select and combine measurements from any number of spots/boxes/circles/profiles/delta
Difference temperature	Delta temperature between the measurement functions and the reference temperature
Reference temperature	Manually set using the difference temperature
Atmospheric transmission correction	Automatic, based on the inputs for distance, atmospheric temperature, and relative humidity
Optics transmission correction	Automatic, based on signals from internal sensors
Emissivity correction	Variable from 0.01 to 1.0 or selected from the materials list
Reflected apparent temperature correction	Automatic, based on the input of the reflected temperature
External optics/windows correction	Automatic, based on the inputs of the window transmission and temperature

Measurement analysis	
Measurement corrections	Emissivity, reflected temperature, relative humidity, atmospheric temperature, object distance, external infrared window compensation
Colors (palettes)	Iron, Rainbow, Rainbow HC, White hot, Black hot, Arctic, Lava
Alarm	
Color alarm (isotherm)	<ul style="list-style-type: none"> • Above • Below • Interval • Condensation (moisture/humidity/dewpoint) • Insulation
Measurement function alarm	Audible/visual alarms (above/below) on any selected measurement function
Set-up	
Set-up commands	Define user presets, Save options, Programmable button, Reset options, Set up camera, Wi-Fi, GPS & compass, Bluetooth, Language, Time & units, Camera information
Languages	Arabic, Czech, Danish, Dutch, English, Finnish, French, German, Greek, Hungarian, Italian, Japanese, Korean, Norwegian, Polish, Portuguese, Russian, simplified Chinese, Swedish, traditional Chinese, Turkish
Service functions	
Camera software update	Use PC software FLIR Tools
Storage of images	
Image storage	Standard JPEG, including digital image and measurement data, on a memory card
Storage media	Removable media SD or SDHC card. Class 10 or better recommended
Image storage mode	<ul style="list-style-type: none"> • Simultaneous storage of thermal and digital images in the same JPEG file • Option to store a digital photo as a separate JPEG file
Time lapse	15 seconds to 24 hours
File formats	<ul style="list-style-type: none"> • Standard JPEG, measurement data included • CSQ, measurement data included
File formats, visual	Standard JPEG, automatically associated with the corresponding thermal image
Image annotations	
Voice	60 seconds (via Bluetooth) stored with the image
Text	Add table, select between predefined templates
Image description	Add short note (stored in the JPEG exif tag)
Sketch	<ul style="list-style-type: none"> • Draw on the thermal/digital image or add predefined stamps • Separate PC software with extensive report generation
METERLiNK	Wireless connection (Bluetooth) to: FLIR meters with METERLiNK

Geographic Information System	
GPS	Location data automatically added to every image from the built-in GPS
Compass	Camera direction automatically added to every image
Video recording in camera	
Radiometric IR-video recording	Real-time radiometric recording (RTRR) to the memory card
Non-radiometric IR-video recording	H.264 to the memory card
Visual video recording	H.264 to the memory card
Video streaming	
Radiometric IR-video streaming	Real-time radiometric streaming (RTRS) via USB
Non-radiometric IR-video streaming	<ul style="list-style-type: none"> • H.264 video using Wi-Fi • H.264 video using USB
Visual video streaming	<ul style="list-style-type: none"> • H.264 video using Wi-Fi • H.264 video using USB
Digital camera	
Built-in digital camera	5 Mpixel with LED light
Digital camera	Field of view adapts to the infrared lens
Video lamp	Built-in LED light
Laser pointer	
Laser	Activated by a dedicated button
Laser alignment	Position is automatically displayed on the infrared image
Laser classification	Class 2
Laser type	Semiconductor AlGaInP diode laser, 1 mW, 635 nm (red)
Data communication interfaces	
Interfaces	USB Micro-B, Bluetooth, Wi-Fi, HDMI
METERLiNK/Bluetooth	Communication with headset and external sensors
Wi-Fi	Infrastructure (network) or AP
SD Card	One card slot for removable SD memory cards
Audio	Microphone headset via Bluetooth for the voice annotation of images
USB	
USB	USB Micro-B: data transfer to and from a PC, uncompressed colorized video
USB, standard	<ul style="list-style-type: none"> • USB 2.0 High Speed • USB Micro-B connector
Video	
Video out	<ul style="list-style-type: none"> • HDMI 640 × 480 • HDMI 1280 × 720 • DVI 640 × 480 • DVI 800 × 600
Video, connector type	HDMI type C

Radio	
Wi-Fi	<ul style="list-style-type: none"> • Standard: 802.11 b/g/n • Frequency range: 2412–2462 MHz • Max. output power: 15 dBm
METERLiNK/Bluetooth	Frequency range: 2402–2480 MHz, supports 2.1 and 4.0
Antenna	Internal
Power system	
Battery type	Rechargeable Li ion battery
Battery operating time	>2.5 hours at 25°C (+68°F) and typical use
Charging system	In camera (AC adapter or 12 V from a vehicle) or two-bay charger
Charging time	2.5 hours to 90% capacity, charging status indicated by LEDs
Charging temperature	0°C to +45°C (+32°F to +113°F), except for the Korean market: +10°C to +45°C (+50°F to +113°F)
External power operation	AC adapter 90–260 V AC, 50/60 Hz or 12 V from a vehicle (cable with a standard plug, optional)
Power management	Automatic power-off functionality, user configurable between 5 minutes, 20 minutes, and no automatic shutdown
Environmental data	
Operating temperature range	–15°C to +50°C (+5°F to +122°F)
Storage temperature range	–40 to +70°C (–40 to +158°F)
Humidity (operating and storage)	IEC 60068-2-30 / 24 hours, 95% relative humidity, 25–40°C (77–104°F) / 2 cycles
EMC	<ul style="list-style-type: none"> • ETSI EN 301 489-1 (radio) • ETSI EN 301 489-17 • EN 61000-6-2 (Immunity) • EN 61000-6-3 (Emission) • FCC 47 CFR Part 15 Class B (Emission) • ICES-003
Radio spectrum	<ul style="list-style-type: none"> • ETSI EN 300 328 • FCC Part 15.247 • RSS-247 Issue 2
Encapsulation	IP 54 (IEC 60529)
Shock	25 g (IEC 60068-2-29)
Vibration	2 g (IEC 60068-2-6)
Safety	EN/UL/CSA/PSE 60950-1
Ergonomics	The viewfinder plus the 120° rotating optical block allow you to point the camera in multiple directions while maintaining a comfortable position
Physical data	
Weight	1.9 kg (4.3 lb.)
Camera size, excl. lens (L × W × H)	167.2 mm × 204.5 mm × 188.3 mm (6.6 in. × 8.0 in. × 7.4 in.)
Tripod mounting	UNC ¼"-20
Housing material	Magnesium

Warranty information	
Warranty	<ul style="list-style-type: none"> • 2 years parts and labor coverage on the camera • 5 years coverage on the battery • 10 years coverage on the detector – the most vital part of the whole camera
Shipping information	
Packaging, size	Cardboard box
List of contents	<ul style="list-style-type: none"> • Infrared camera with lens • Battery (2 ea.) • Battery charger • Bluetooth headset • Calibration certificate • FLIR Tools+ license card • Hard transport case • HDMI-HDMI cable • IR lens, 45° • Lens cap • Memory card • Neck strap • Power supply, including multi-plugs • Printed documentation • USB cable, Std A to Micro-B
Packaging, weight	6.9 kg (15.2 lb.)
Packaging, size	494 × 355 × 188 mm (19.4 × 14.0 × 7.4 in.)
EAN-13	7332558011294
UPC-12	845188012175
Country of origin	Sweden

Supplies & accessories:

- T199064; IR lens f=36mm (28°) with case
- T199065; Close-up lens 3x (51 micron) with case
- T199066; IR lens f=21.2mm (45°) with case
- T199077; IR lens f=83.4mm (12°) with case
- T910814; Power supply, incl. multi plugs
- T198126; Battery charger, incl. power supply with multi plugs T6xx
- T199364ACC; Battery Li-ion 3.65 V, 8.5 Ah, 32 Wh
- T911650ACC; Memory card SD Card 8 GB
- T198509; Cigarette lighter adapter kit, 12 VDC, 1.2 m/3.9 ft.
- T910930ACC; HDMI type C to DVI cable 1.5 m
- T910891ACC; HDMI type C to HDMI type A cable 1.5 m
- T198497; Large eyecup
- T197771ACC; Bluetooth Headset
- T911093; Tool belt
- T198533; USB cable Std A <-> Micro B
- T198586; FLIR Reporter Professional (license only)
- T198584; FLIR Tools
- T198583; FLIR Tools+ (download card incl. license key)
- DSW-10000; FLIR IR Camera Player
- APP-10002; FLIR Tools Mobile (Android Application)
- APP-10003; FLIR Tools Mobile (iPad/iPhone Application)
- APP-10004; FLIR Tools (MacOS Application)
- T199233; FLIR Atlas SDK for .NET
- T199234; FLIR Atlas SDK for MATLAB

30.12 FLIR T1020 28°, 12°, and 45°

P/N: 72501-0106

Rev.: 46142

General description	
The FLIR T1020 is designed for the expert requiring the highest performance and the latest technology available. The camera combines excellent ergonomics and feature-rich flexibility with superior image quality at an infrared resolution of 1024 × 768 pixels.	
Benefits:	
<ul style="list-style-type: none"> • Flexible and feature rich: A wide variety of measuring and analysis functions make the FLIR T1020 flexible for your every need. Two programmable buttons provide easy access to favorite functions. • Highest performance with the latest technology: The FLIR T1020 is equipped with the innovative Multi Spectral Dynamic Imaging (MSX) feature, which produces an image richer in detail than ever before. With its continuous autofocus, the FLIR T1020 is a fully automatic infrared camera. • Support for UltraMax: When enabling UltraMax in the camera, the resolution of images can be substantially enhanced when importing the images into FLIR Tools. 	
Imaging and optical data	
IR resolution	1024 × 768 pixels
MSX resolution	1024 × 768 pixels
UltraMax	Yes
Thermal sensitivity/NETD	<20 mK @ +30°C (+86°F)
Field of view (FOV)	28° × 21°
Minimum IR focus distance	0.4 m (1.32 ft.)
Minimum IR–visual alignment distance	0.4 m (1.32 ft.)
Focal length	36 mm (1.42 in.)
Spatial resolution (IFOV)	0.47 mrad
Lens identification	Automatic
F-number	1.15
Image frequency	30 Hz
Focus	One shot or manual
Digital zoom	1–8× continuous
Digital image enhancement	Adaptive digital noise reduction
Detector data	
Detector type	Focal plane array (FPA), uncooled microbolometer
Spectral range	7.5–14 μm
Detector pitch	17 μm
Image presentation	
Display	Built-in touch screen, 4.3 in. wide screen LCD, 800 × 480 pixels
Display type	Capacitive touch screen
Auto orientation	Automatic landscape or portrait
Viewfinder	Built-in 800 × 480 pixels
Automatic image adjustment	Continuous, histogram based
Automatic image adjustment, type	Standard or histogram based on the image content
Manual image adjustment	Linear based, possible to adjust level/span/max./min.

Image presentation modes	
Image modes	Thermal, thermal MSX, picture in picture, digital camera
Infrared image	Full color infrared image
Visual image	Full color visual image
Multi Spectral Dynamic Imaging (MSX)	Thermal image with enhanced detail presentation
Picture in Picture	Resizable and movable infrared area on the visual image
Gallery	<ul style="list-style-type: none"> Review thumbnail/full image on the camera Edit measurements/palettes/image modes on the camera

Measurement		
Object temperature range		Accuracy
-40 to +150°C (-40 to +302°F)	-40 to +5°C (-40 to +41°F)	±2°C (±3.6°F)
	+5 to +100°C (+41 to +212°F)	±1°C (±1.8°F)
	+100 to +150°C (+212 to +302°F)	±1%
0 to +650°C (+32 to +1202°F)	0 to +100°C (+32 to +212°F)	±2°C (±3.6°F)
	+100 to +650°C (+212 to +1202°F)	±2%
+300 to +2000°C (+572 to +3632°F)	+300 to +2000°C (+572 to +3632°F)	±2%

**NOTE**

For HSI use, above 30 Hz frame rate, the typical accuracy will be ±2.5°C (±4.5°F), or 2.5% of reading @ 25°C (77°F).

Measurement analysis	
Spotmeter	10
Area	5 + 5 areas (boxes and circles) with max./min./average
Profile	1 line profile with max./min. temperature
Automatic hot/cold detection	Auto hot or cold spotmeter markers within the area and profile
Measurement presets	No measurements, Center spot, Hot spot, Cold spot, User preset 1, User preset 2
User presets	The user can select and combine measurements from any number of spots/boxes/circles/profiles/delta
Difference temperature	Delta temperature between the measurement functions and the reference temperature
Reference temperature	Manually set using the difference temperature
Atmospheric transmission correction	Automatic, based on the inputs for distance, atmospheric temperature, and relative humidity
Optics transmission correction	Automatic, based on signals from internal sensors
Emissivity correction	Variable from 0.01 to 1.0 or selected from the materials list
Reflected apparent temperature correction	Automatic, based on the input of the reflected temperature
External optics/windows correction	Automatic, based on the inputs of the window transmission and temperature

Measurement analysis	
Measurement corrections	Emissivity, reflected temperature, relative humidity, atmospheric temperature, object distance, external infrared window compensation
Colors (palettes)	Iron, Rainbow, Rainbow HC, White hot, Black hot, Arctic, Lava
Alarm	
Color alarm (isotherm)	<ul style="list-style-type: none"> • Above • Below • Interval • Condensation (moisture/humidity/dewpoint) • Insulation
Measurement function alarm	Audible/visual alarms (above/below) on any selected measurement function
Set-up	
Set-up commands	Define user presets, Save options, Programmable button, Reset options, Set up camera, Wi-Fi, GPS & compass, Bluetooth, Language, Time & units, Camera information
Languages	Arabic, Czech, Danish, Dutch, English, Finnish, French, German, Greek, Hungarian, Italian, Japanese, Korean, Norwegian, Polish, Portuguese, Russian, simplified Chinese, Swedish, traditional Chinese, Turkish
Service functions	
Camera software update	Use PC software FLIR Tools
Storage of images	
Image storage	Standard JPEG, including digital image and measurement data, on a memory card
Storage media	Removable media SD or SDHC card. Class 10 or better recommended
Image storage mode	<ul style="list-style-type: none"> • Simultaneous storage of thermal and digital images in the same JPEG file • Option to store a digital photo as a separate JPEG file
Time lapse	15 seconds to 24 hours
File formats	<ul style="list-style-type: none"> • Standard JPEG, measurement data included • CSQ, measurement data included
File formats, visual	Standard JPEG, automatically associated with the corresponding thermal image
Image annotations	
Voice	60 seconds (via Bluetooth) stored with the image
Text	Add table, select between predefined templates
Image description	Add short note (stored in the JPEG exif tag)
Sketch	<ul style="list-style-type: none"> • Draw on the thermal/digital image or add predefined stamps • Separate PC software with extensive report generation
METERLiNK	Wireless connection (Bluetooth) to: FLIR meters with METERLiNK

Geographic Information System	
GPS	Location data automatically added to every image from the built-in GPS
Compass	Camera direction automatically added to every image
Video recording in camera	
Radiometric IR-video recording	Real-time radiometric recording (RTRR) to the memory card
Non-radiometric IR-video recording	H.264 to the memory card
Visual video recording	H.264 to the memory card
Video streaming	
Radiometric IR-video streaming	Real-time radiometric streaming (RTRS) via USB
Non-radiometric IR-video streaming	<ul style="list-style-type: none"> • H.264 video using Wi-Fi • H.264 video using USB
Visual video streaming	<ul style="list-style-type: none"> • H.264 video using Wi-Fi • H.264 video using USB
Digital camera	
Built-in digital camera	5 Mpixel with LED light
Digital camera	Field of view adapts to the infrared lens
Video lamp	Built-in LED light
Laser pointer	
Laser	Activated by a dedicated button
Laser alignment	Position is automatically displayed on the infrared image
Laser classification	Class 2
Laser type	Semiconductor AlGaInP diode laser, 1 mW, 635 nm (red)
Data communication interfaces	
Interfaces	USB Micro-B, Bluetooth, Wi-Fi, HDMI
METERLiNK/Bluetooth	Communication with headset and external sensors
Wi-Fi	Infrastructure (network) or AP
SD Card	One card slot for removable SD memory cards
Audio	Microphone headset via Bluetooth for the voice annotation of images
USB	
USB	USB Micro-B: data transfer to and from a PC, uncompressed colorized video
USB, standard	<ul style="list-style-type: none"> • USB 2.0 High Speed • USB Micro-B connector
Video	
Video out	<ul style="list-style-type: none"> • HDMI 640 × 480 • HDMI 1280 × 720 • DVI 640 × 480 • DVI 800 × 600
Video, connector type	HDMI type C

Radio	
Wi-Fi	<ul style="list-style-type: none"> • Standard: 802.11 b/g/n • Frequency range: 2412–2462 MHz • Max. output power: 15 dBm
METERLiNK/Bluetooth	Frequency range: 2402–2480 MHz, supports 2.1 and 4.0
Antenna	Internal
Power system	
Battery type	Rechargeable Li ion battery
Battery operating time	>2.5 hours at 25°C (+68°F) and typical use
Charging system	In camera (AC adapter or 12 V from a vehicle) or two-bay charger
Charging time	2.5 hours to 90% capacity, charging status indicated by LEDs
Charging temperature	0°C to +45°C (+32°F to +113°F), except for the Korean market: +10°C to +45°C (+50°F to +113°F)
External power operation	AC adapter 90–260 V AC, 50/60 Hz or 12 V from a vehicle (cable with a standard plug, optional)
Power management	Automatic power-off functionality, user configurable between 5 minutes, 20 minutes, and no automatic shutdown
Environmental data	
Operating temperature range	–15°C to +50°C (+5°F to +122°F)
Storage temperature range	–40 to +70°C (–40 to +158°F)
Humidity (operating and storage)	IEC 60068-2-30 / 24 hours, 95% relative humidity, 25–40°C (77–104°F) / 2 cycles
EMC	<ul style="list-style-type: none"> • ETSI EN 301 489-1 (radio) • ETSI EN 301 489-17 • EN 61000-6-2 (Immunity) • EN 61000-6-3 (Emission) • FCC 47 CFR Part 15 Class B (Emission) • ICES-003
Radio spectrum	<ul style="list-style-type: none"> • ETSI EN 300 328 • FCC Part 15.247 • RSS-247 Issue 2
Encapsulation	IP 54 (IEC 60529)
Shock	25 g (IEC 60068-2-29)
Vibration	2 g (IEC 60068-2-6)
Safety	EN/UL/CSA/PSE 60950-1
Ergonomics	The viewfinder plus the 120° rotating optical block allow you to point the camera in multiple directions while maintaining a comfortable position
Physical data	
Weight	1.9 kg (4.3 lb.)
Camera size, excl. lens (L × W × H)	167.2 mm × 204.5 mm × 188.3 mm (6.6 in. × 8.0 in. × 7.4 in.)
Tripod mounting	UNC ¼"-20
Housing material	Magnesium

Warranty information	
Warranty	<ul style="list-style-type: none"> • 2 years parts and labor coverage on the camera • 5 years coverage on the battery • 10 years coverage on the detector – the most vital part of the whole camera
Shipping information	
Packaging, type	Cardboard box
List of contents	<ul style="list-style-type: none"> • Infrared camera with lens • Battery (2 ea.) • Battery charger • Bluetooth headset • Calibration certificate • FLIR Tools+ license card • Hard transport case • HDMI-HDMI cable • IR lens, 12° • IR lens, 45° • Lens cap • Memory card • Neck strap • Power supply, including multi-plugs • Printed documentation • USB cable, Std A to Micro-B
Packaging, weight	8.2 kg (18.0 lb.)
Packaging, size	494 × 355 × 188 mm (19.4 × 14.0 × 7.4 in.)
EAN-13	7332558011300
UPC-12	845188012182
Country of origin	Sweden

Supplies & accessories:

- T199064; IR lens f=36mm (28°) with case
- T199065; Close-up lens 3x (51 micron) with case
- T199066; IR lens f=21.2mm (45°) with case
- T199077; IR lens f=83.4mm (12°) with case
- T910814; Power supply, incl. multi plugs
- T198126; Battery charger, incl. power supply with multi plugs T6xx
- T199364ACC; Battery Li-ion 3.65 V, 8.5 Ah, 32 Wh
- T911650ACC; Memory card SD Card 8 GB
- T198509; Cigarette lighter adapter kit, 12 VDC, 1.2 m/3.9 ft.
- T910930ACC; HDMI type C to DVI cable 1.5 m
- T910891ACC; HDMI type C to HDMI type A cable 1.5 m
- T198497; Large eyecup
- T197771ACC; Bluetooth Headset
- T911093; Tool belt
- T198533; USB cable Std A <-> Micro B
- T198586; FLIR Reporter Professional (license only)
- T198584; FLIR Tools
- T198583; FLIR Tools+ (download card incl. license key)
- DSW-10000; FLIR IR Camera Player
- APP-10002; FLIR Tools Mobile (Android Application)
- APP-10003; FLIR Tools Mobile (iPad/iPhone Application)
- APP-10004; FLIR Tools (MacOS Application)
- T199233; FLIR Atlas SDK for .NET
- T199234; FLIR Atlas SDK for MATLAB

30.13 FLIR T1030sc 12°

P/N: 72501-0201

Rev.: 46144

General description	
<p>The FLIR T1030sc is designed for the expert requiring the highest performance and the latest technology available. The camera combines excellent ergonomics and feature-rich flexibility with superior image quality at an infrared resolution of 1024 × 768 pixels. High accuracy and sensitivity together with radiometric recording and streaming options make the FLIR T1030sc well suited for advanced research and development.</p>	
<p>Benefits:</p> <ul style="list-style-type: none"> • Tailor made for research and development: The FLIR T1030sc has high accuracy and high sensitivity, to accurately measure the smallest temperature differences. With real-time radiometric recording, it is possible to capture fast events on the camera's SD card for further analysis by the supplied analysis software. • Flexible and feature rich: A wide variety of measuring and analysis functions make the FLIR T1030sc flexible for your every need. Two programmable buttons provide easy access to favorite functions. • Highest performance with the latest technology: The FLIR T1030sc is equipped with the innovative Multi Spectral Dynamic Imaging (MSX) feature, which produces an image richer in detail than ever before. With its continuous autofocus, the FLIR T1030sc is a fully automatic infrared camera. • Support for UltraMax: When enabling UltraMax in the camera, the resolution of images can be substantially enhanced when importing the images into FLIR Tools. 	
Imaging and optical data	
IR resolution	1024 × 768 pixels
MSX resolution	1024 × 768 pixels
UltraMax	Yes
Thermal sensitivity/NETD	<20 mK @ +30°C (+86°F)
Field of view (FOV)	12° × 9°
Minimum IR focus distance	1.3 m (4.26 ft.)
Minimum IR–visual alignment distance	1.3 m (4.26 ft.)
Focal length	83.4 mm (3.28 in.)
Spatial resolution (IFOV)	0.20 mrad
Lens identification	Automatic
F-number	1.2
Image frequency	30 Hz
Focus	One shot or manual
Digital zoom	1–8× continuous
Digital image enhancement	Adaptive digital noise reduction
Detector data	
Detector type	Focal plane array (FPA), uncooled microbolometer
Spectral range	7.5–14 μm
Detector pitch	17 μm
Time constant	< 10 ms
Image presentation	
Display	Built-in touch screen, 4.3 in. wide screen LCD, 800 × 480 pixels
Display type	Capacitive touch screen
Auto orientation	Automatic landscape or portrait

Image presentation	
Viewfinder	Built-in 800 × 480 pixels
Automatic image adjustment	Continuous, histogram based
Automatic image adjustment, type	Standard or histogram based on the image content
Manual image adjustment	Linear based, possible to adjust level/span/max./min.

Image presentation modes	
Image modes	Thermal, thermal MSX, picture in picture, digital camera
Infrared image	Full color infrared image
Visual image	Full color visual image
Multi Spectral Dynamic Imaging (MSX)	Thermal image with enhanced detail presentation
Picture in Picture	Resizable and movable infrared area on the visual image
Gallery	<ul style="list-style-type: none"> Review thumbnail/full image on the camera Edit measurements/palettes/image modes on the camera

Measurement		
Object temperature range		Accuracy
-40 to +150°C (-40 to +302°F)	-40 to +5°C (-40 to +41°F)	±2°C (±3.6°F)
	+5 to +100°C (+41 to +212°F)	±1°C (±1.8°F)
	+100 to +150°C (+212 to +302°F)	±1%
0 to +650°C (+32 to +1202°F)	0 to +100°C (+32 to +212°F)	±2°C (±3.6°F)
	+100 to +650°C (+212 to +1202°F)	±2%
+300 to +2000°C (+572 to +3632°F)	+300 to +2000°C (+572 to +3632°F)	±2%

**NOTE**

For HSI use, above 30 Hz frame rate, the typical accuracy will be ±2.5°C (±4.5°F), or 2.5% of reading @ 25°C (77°F).

Measurement analysis	
Spotmeter	10
Area	5 + 5 areas (boxes and circles) with max./min./average
Profile	1 line profile with max./min. temperature
Automatic hot/cold detection	Auto hot or cold spotmeter markers within the area and profile
Measurement presets	No measurements, Center spot, Hot spot, Cold spot, User preset 1, User preset 2
User presets	The user can select and combine measurements from any number of spots/boxes/circles/profiles/delta
Difference temperature	Delta temperature between the measurement functions and the reference temperature
Reference temperature	Manually set using the difference temperature

Measurement analysis	
Atmospheric transmission correction	Automatic, based on the inputs for distance, atmospheric temperature, and relative humidity
Optics transmission correction	Automatic, based on signals from internal sensors
Emissivity correction	Variable from 0.01 to 1.0 or selected from the materials list
Reflected apparent temperature correction	Automatic, based on the input of the reflected temperature
External optics/windows correction	Automatic, based on the inputs of the window transmission and temperature
Measurement corrections	Emissivity, reflected temperature, relative humidity, atmospheric temperature, object distance, external infrared window compensation
Colors (palettes)	Iron, Rainbow, Rainbow HC, White hot, Black hot, Arctic, Lava
Alarm	
Color alarm (isotherm)	<ul style="list-style-type: none"> • Above • Below • Interval • Condensation (moisture/humidity/dewpoint) • Insulation
Measurement function alarm	Audible/visual alarms (above/below) on any selected measurement function
Set-up	
Set-up commands	Define user presets, Save options, Programmable button, Reset options, Set up camera, Wi-Fi, GPS & compass, Bluetooth, Language, Time & units, Camera information
Languages	Arabic, Czech, Danish, Dutch, English, Finnish, French, German, Greek, Hungarian, Italian, Japanese, Korean, Norwegian, Polish, Portuguese, Russian, simplified Chinese, Swedish, traditional Chinese, Turkish
Service functions	
Camera software update	Use PC software FLIR Tools
Storage of images	
Image storage	Standard JPEG, including digital image and measurement data, on a memory card
Storage media	Removable media SD or SDHC card. Class 10 or better recommended
Image storage mode	<ul style="list-style-type: none"> • Simultaneous storage of thermal and digital images in the same JPEG file • Option to store a digital photo as a separate JPEG file
Time lapse	15 seconds to 24 hours
File formats	<ul style="list-style-type: none"> • Standard JPEG, measurement data included • CSQ, measurement data included
File formats, visual	Standard JPEG, automatically associated with the corresponding thermal image
Image annotations	
Voice	60 seconds (via Bluetooth) stored with the image
Text	Add table, select between predefined templates

Image annotations	
Image description	Add short note (stored in the JPEG exif tag)
Sketch	<ul style="list-style-type: none"> • Draw on the thermal/digital image or add pre-defined stamps • Separate PC software with extensive report generation
METERLiNK	Wireless connection (Bluetooth) to: FLIR meters with METERLiNK
Geographic Information System	
GPS	Location data automatically added to every image from the built-in GPS
Compass	Camera direction automatically added to every image
Video recording in camera	
Radiometric IR-video recording	Real-time radiometric recording (RTRR) to the memory card
Non-radiometric IR-video recording	H.264 to the memory card
Visual video recording	H.264 to the memory card
Video streaming	
Radiometric IR-video streaming	<ul style="list-style-type: none"> • Full dynamic un-compressed 120 Hz 16-bit full frame (2 Gbit) to a PC using an HSI box • Real-time radiometric streaming 30 Hz (RTRS) via USB
Non-radiometric IR-video streaming	<ul style="list-style-type: none"> • H.264 video using Wi-Fi • H.264 video using USB
Visual video streaming	<ul style="list-style-type: none"> • H.264 video using Wi-Fi • H.264 video using USB
Windowing	<ul style="list-style-type: none"> • 30 Hz: 1024 × 768 (full image height) • Based on 30 Hz: 120 Hz windowing 1024 × 192 (¼ of full image height), for range -40 to +150°C (-40 to +302°F) • 120 Hz: 1024 × 768 (full image height) • Based on 120 Hz: 240 Hz windowing 1024 × 384 (½ of full image height), for range 0 to +650°C (+32 to +1202°F) and range +300 to +2000°C (+572 to +3632°F)
Digital camera	
Built-in digital camera	5 Mpixel with LED light
Digital camera	Field of view adapts to the infrared lens
Video lamp	Built-in LED light
Laser pointer	
Laser	Activated by a dedicated button
Laser alignment	Position is automatically displayed on the infrared image
Laser classification	Class 2
Laser type	Semiconductor AlGaInP diode laser, 1 mW, 635 nm (red)

Data communication interfaces	
Interfaces	USB Micro-B, Bluetooth, Wi-Fi, HDMI, USB3 Vision via HSI box
METERLiNK/Bluetooth	Communication with headset and external sensors
Wi-Fi	Infrastructure (network) or AP
SD Card	One card slot for removable SD memory cards
Audio	Microphone headset via Bluetooth for the voice annotation of images
USB	
USB	USB Micro-B: data transfer to and from a PC, uncompressed colorized video
USB, standard	<ul style="list-style-type: none"> • USB 2.0 High Speed • USB Micro-B connector • USB3 Vision via HSI box
Video	
Video out	<ul style="list-style-type: none"> • HDMI 640 × 480 • HDMI 1280 × 720 • DVI 640 × 480 • DVI 800 × 600
Video, connector type	HDMI type C
Radio	
Wi-Fi	<ul style="list-style-type: none"> • Standard: 802.11 b/g/n • Frequency range: 2412–2462 MHz • Max. output power: 15 dBm
METERLiNK/Bluetooth	Frequency range: 2402–2480 MHz, supports 2.1 and 4.0
Antenna	Internal
Power system	
Battery type	Rechargeable Li ion battery
Battery operating time	>2.5 hours at 25°C (+68°F) and typical use
Charging system	In camera (AC adapter or 12 V from a vehicle) or two-bay charger
Charging time	2.5 hours to 90% capacity, charging status indicated by LEDs
Charging temperature	0°C to +45°C (+32°F to +113°F), except for the Korean market: +10°C to +45°C (+50°F to +113°F)
External power operation	AC adapter 90–260 V AC, 50/60 Hz or 12 V from a vehicle (cable with a standard plug, optional)
Power management	Automatic power-off functionality, user configurable between 5 minutes, 20 minutes, and no automatic shutdown
Environmental data	
Operating temperature range	–15°C to +50°C (+5°F to +122°F)
Storage temperature range	–40 to +70°C (–40 to +158°F)
Humidity (operating and storage)	IEC 60068-2-30 / 24 hours, 95% relative humidity, 25–40°C (77–104°F) / 2 cycles

Environmental data	
EMC	<ul style="list-style-type: none"> • ETSI EN 301 489-1 (radio) • ETSI EN 301 489-17 • EN 61000-6-2 (Immunity) • EN 61000-6-3 (Emission) • FCC 47 CFR Part 15 Class B (Emission) • ICES-003
Radio spectrum	<ul style="list-style-type: none"> • ETSI EN 300 328 • FCC Part 15.247 • RSS-247 Issue 2
Encapsulation	IP 54 (IEC 60529)
Shock	25 g (IEC 60068-2-29)
Vibration	2 g (IEC 60068-2-6)
Safety	EN/UL/CSA/PSE 60950-1
Ergonomics	The viewfinder plus the 120° rotating optical block allow you to point the camera in multiple directions while maintaining a comfortable position
Physical data	
Weight	2.1 kg (4.6 lb.)
Camera size, excl. lens (L x W x H)	167.2 mm x 204.5 mm x 188.3 mm (6.6 in. x 8.0 in. x 7.4 in.)
Tripod mounting	UNC ¼"-20
Housing material	Magnesium
Warranty information	
Warranty	<ul style="list-style-type: none"> • 2 years parts and labor coverage on the camera • 5 years coverage on the battery • 10 years coverage on the detector – the most vital part of the whole camera
Shipping information	
List of contents	<ul style="list-style-type: none"> • Infrared camera with lens • Battery (2 ea.) • Battery charger • Bluetooth headset • Calibration certificate • FLIR Tools+ license card • FLIR T10xx SC kit (in separate hard transport case): <ul style="list-style-type: none"> ◦ High-speed interface ◦ USB cable (USB 3), 3 m (10 ft.) ◦ Digital I/O connector ◦ FLIR ResearchIR Max license card ◦ Printed documentation • Hard transport case • HDMI-HDMI cable • Lens cap • Memory card • Neck strap • Power supply, including multi-plugs • Printed documentation • USB cable, Std A to Micro-B
EAN-13	7332558010303
UPC-12	845188010942
Country of origin	Sweden

Supplies & accessories:

- T199064; IR lens f=36mm (28°) with case
- T199066; IR lens f=21.2mm (45°) with case
- T199077; IR lens f=83.4mm (12°) with case
- T910814; Power supply, incl. multi plugs
- T198126; Battery charger, incl. power supply with multi plugs T6xx
- T199364ACC; Battery Li-ion 3.65 V, 8.5 Ah, 32 Wh
- T911650ACC; Memory card SD Card 8 GB
- T198509; Cigarette lighter adapter kit, 12 VDC, 1.2 m/3.9 ft.
- T910930ACC; HDMI type C to DVI cable 1.5 m
- T910891ACC; HDMI type C to HDMI type A cable 1.5 m
- 72500-0002; FLIR T10xx SC kit
- T198497; Large eyecup
- T197771ACC; Bluetooth Headset
- T911093; Tool belt
- T198533; USB cable Std A <-> Micro B
- T198586; FLIR Reporter Professional (license only)
- T198584; FLIR Tools
- T198583; FLIR Tools+ (download card incl. license key)
- DSW-10000; FLIR IR Camera Player
- APP-10002; FLIR Tools Mobile (Android Application)
- APP-10003; FLIR Tools Mobile (iPad/iPhone Application)
- APP-10004; FLIR Tools (MacOS Application)
- T198697; FLIR ResearchIR Max + HSDR 4 (hardware sec. dev.)
- T199014; FLIR ResearchIR Max + HSDR 4 (printed license key)
- T199044; FLIR ResearchIR Max + HSDR 4 Upgrade (printed license key)
- T198696; FLIR ResearchIR Max 4 (hardware sec. dev.)
- T199013; FLIR ResearchIR Max 4 (printed license key)
- T199043; FLIR ResearchIR Max 4 Upgrade (printed license key)
- T198731; FLIR ResearchIR Standard 4 (hardware sec. dev.)
- T199012; FLIR ResearchIR Standard 4 (printed license key)
- T199042; FLIR ResearchIR Standard 4 Upgrade (printed license key)
- T199233; FLIR Atlas SDK for .NET
- T199234; FLIR Atlas SDK for MATLAB

30.14 FLIR T1030sc 28°

P/N: 72501-0202

Rev.: 46147

General description	
<p>The FLIR T1030sc is designed for the expert requiring the highest performance and the latest technology available. The camera combines excellent ergonomics and feature-rich flexibility with superior image quality at an infrared resolution of 1024 × 768 pixels. High accuracy and sensitivity together with radiometric recording and streaming options make the FLIR T1030sc well suited for advanced research and development.</p>	
<p>Benefits:</p> <ul style="list-style-type: none"> • Tailor made for research and development: The FLIR T1030sc has high accuracy and high sensitivity, to accurately measure the smallest temperature differences. With real-time radiometric recording, it is possible to capture fast events on the camera's SD card for further analysis by the supplied analysis software. • Flexible and feature rich: A wide variety of measuring and analysis functions make the FLIR T1030sc flexible for your every need. Two programmable buttons provide easy access to favorite functions. • Highest performance with the latest technology: The FLIR T1030sc is equipped with the innovative Multi Spectral Dynamic Imaging (MSX) feature, which produces an image richer in detail than ever before. With its continuous autofocus, the FLIR T1030sc is a fully automatic infrared camera. • Support for UltraMax: When enabling UltraMax in the camera, the resolution of images can be substantially enhanced when importing the images into FLIR Tools. 	
Imaging and optical data	
IR resolution	1024 × 768 pixels
MSX resolution	1024 × 768 pixels
UltraMax	Yes
Thermal sensitivity/NETD	<20 mK @ +30°C (+86°F)
Field of view (FOV)	28° × 21°
Minimum IR focus distance	0.4 m (1.32 ft.)
Minimum IR–visual alignment distance	0.4 m (1.32 ft.)
Focal length	36 mm (1.42 in.)
Spatial resolution (IFOV)	0.47 mrad
Lens identification	Automatic
F-number	1.15
Image frequency	30 Hz
Focus	One shot or manual
Digital zoom	1–8× continuous
Digital image enhancement	Adaptive digital noise reduction
Detector data	
Detector type	Focal plane array (FPA), uncooled microbolometer
Spectral range	7.5–14 μm
Detector pitch	17 μm
Time constant	< 10 ms
Image presentation	
Display	Built-in touch screen, 4.3 in. wide screen LCD, 800 × 480 pixels
Display type	Capacitive touch screen
Auto orientation	Automatic landscape or portrait

Image presentation	
Viewfinder	Built-in 800 × 480 pixels
Automatic image adjustment	Continuous, histogram based
Automatic image adjustment, type	Standard or histogram based on the image content
Manual image adjustment	Linear based, possible to adjust level/span/max./min.

Image presentation modes	
Image modes	Thermal, thermal MSX, picture in picture, digital camera
Infrared image	Full color infrared image
Visual image	Full color visual image
Multi Spectral Dynamic Imaging (MSX)	Thermal image with enhanced detail presentation
Picture in Picture	Resizable and movable infrared area on the visual image
Gallery	<ul style="list-style-type: none"> Review thumbnail/full image on the camera Edit measurements/palettes/image modes on the camera

Measurement		
Object temperature range		Accuracy
-40 to +150°C (-40 to +302°F)	-40 to +5°C (-40 to +41°F)	±2°C (±3.6°F)
	+5 to +100°C (+41 to +212°F)	±1°C (±1.8°F)
	+100 to +150°C (+212 to +302°F)	±1%
0 to +650°C (+32 to +1202°F)	0 to +100°C (+32 to +212°F)	±2°C (±3.6°F)
	+100 to +650°C (+212 to +1202°F)	±2%
+300 to +2000°C (+572 to +3632°F)	+300 to +2000°C (+572 to +3632°F)	±2%

**NOTE**

For HSI use, above 30 Hz frame rate, the typical accuracy will be ±2.5°C (±4.5°F), or 2.5% of reading @ 25°C (77°F).

Measurement analysis	
Spotmeter	10
Area	5 + 5 areas (boxes and circles) with max./min./average
Profile	1 line profile with max./min. temperature
Automatic hot/cold detection	Auto hot or cold spotmeter markers within the area and profile
Measurement presets	No measurements, Center spot, Hot spot, Cold spot, User preset 1, User preset 2
User presets	The user can select and combine measurements from any number of spots/boxes/circles/profiles/delta
Difference temperature	Delta temperature between the measurement functions and the reference temperature
Reference temperature	Manually set using the difference temperature

Measurement analysis	
Atmospheric transmission correction	Automatic, based on the inputs for distance, atmospheric temperature, and relative humidity
Optics transmission correction	Automatic, based on signals from internal sensors
Emissivity correction	Variable from 0.01 to 1.0 or selected from the materials list
Reflected apparent temperature correction	Automatic, based on the input of the reflected temperature
External optics/windows correction	Automatic, based on the inputs of the window transmission and temperature
Measurement corrections	Emissivity, reflected temperature, relative humidity, atmospheric temperature, object distance, external infrared window compensation
Colors (palettes)	Iron, Rainbow, Rainbow HC, White hot, Black hot, Arctic, Lava
Alarm	
Color alarm (isotherm)	<ul style="list-style-type: none"> • Above • Below • Interval • Condensation (moisture/humidity/dewpoint) • Insulation
Measurement function alarm	Audible/visual alarms (above/below) on any selected measurement function
Set-up	
Set-up commands	Define user presets, Save options, Programmable button, Reset options, Set up camera, Wi-Fi, GPS & compass, Bluetooth, Language, Time & units, Camera information
Languages	Arabic, Czech, Danish, Dutch, English, Finnish, French, German, Greek, Hungarian, Italian, Japanese, Korean, Norwegian, Polish, Portuguese, Russian, simplified Chinese, Swedish, traditional Chinese, Turkish
Service functions	
Camera software update	Use PC software FLIR Tools
Storage of images	
Image storage	Standard JPEG, including digital image and measurement data, on a memory card
Storage media	Removable media SD or SDHC card. Class 10 or better recommended
Image storage mode	<ul style="list-style-type: none"> • Simultaneous storage of thermal and digital images in the same JPEG file • Option to store a digital photo as a separate JPEG file
Time lapse	15 seconds to 24 hours
File formats	<ul style="list-style-type: none"> • Standard JPEG, measurement data included • CSQ, measurement data included
File formats, visual	Standard JPEG, automatically associated with the corresponding thermal image
Image annotations	
Voice	60 seconds (via Bluetooth) stored with the image
Text	Add table, select between predefined templates

Image annotations	
Image description	Add short note (stored in the JPEG exif tag)
Sketch	<ul style="list-style-type: none"> • Draw on the thermal/digital image or add pre-defined stamps • Separate PC software with extensive report generation
METERLiNK	Wireless connection (Bluetooth) to: FLIR meters with METERLiNK
Geographic Information System	
GPS	Location data automatically added to every image from the built-in GPS
Compass	Camera direction automatically added to every image
Video recording in camera	
Radiometric IR-video recording	Real-time radiometric recording (RTRR) to the memory card
Non-radiometric IR-video recording	H.264 to the memory card
Visual video recording	H.264 to the memory card
Video streaming	
Radiometric IR-video streaming	<ul style="list-style-type: none"> • Full dynamic un-compressed 120 Hz 16-bit full frame (2 Gbit) to a PC using an HSI box • Real-time radiometric streaming 30 Hz (RTRS) via USB
Non-radiometric IR-video streaming	<ul style="list-style-type: none"> • H.264 video using Wi-Fi • H.264 video using USB
Visual video streaming	<ul style="list-style-type: none"> • H.264 video using Wi-Fi • H.264 video using USB
Windowing	<ul style="list-style-type: none"> • 30 Hz: 1024 × 768 (full image height) • Based on 30 Hz: 120 Hz windowing 1024 × 192 (¼ of full image height), for range -40 to +150°C (-40 to +302°F) • 120 Hz: 1024 × 768 (full image height) • Based on 120 Hz: 240 Hz windowing 1024 × 384 (½ of full image height), for range 0 to +650°C (+32 to +1202°F) and range +300 to +2000°C (+572 to +3632°F)
Digital camera	
Built-in digital camera	5 Mpixel with LED light
Digital camera	Field of view adapts to the infrared lens
Video lamp	Built-in LED light
Laser pointer	
Laser	Activated by a dedicated button
Laser alignment	Position is automatically displayed on the infrared image
Laser classification	Class 2
Laser type	Semiconductor AlGaInP diode laser, 1 mW, 635 nm (red)

Data communication interfaces	
Interfaces	USB Micro-B, Bluetooth, Wi-Fi, HDMI, USB3 Vision via HSI box
METERLiNK/Bluetooth	Communication with headset and external sensors
Wi-Fi	Infrastructure (network) or AP
SD Card	One card slot for removable SD memory cards
Audio	Microphone headset via Bluetooth for the voice annotation of images
USB	
USB	USB Micro-B: data transfer to and from a PC, uncompressed colorized video
USB, standard	<ul style="list-style-type: none"> • USB 2.0 High Speed • USB Micro-B connector • USB3 Vision via HSI box
Video	
Video out	<ul style="list-style-type: none"> • HDMI 640 × 480 • HDMI 1280 × 720 • DVI 640 × 480 • DVI 800 × 600
Video, connector type	HDMI type C
Radio	
Wi-Fi	<ul style="list-style-type: none"> • Standard: 802.11 b/g/n • Frequency range: 2412–2462 MHz • Max. output power: 15 dBm
METERLiNK/Bluetooth	Frequency range: 2402–2480 MHz, supports 2.1 and 4.0
Antenna	Internal
Power system	
Battery type	Rechargeable Li ion battery
Battery operating time	>2.5 hours at 25°C (+68°F) and typical use
Charging system	In camera (AC adapter or 12 V from a vehicle) or two-bay charger
Charging time	2.5 hours to 90% capacity, charging status indicated by LEDs
Charging temperature	0°C to +45°C (+32°F to +113°F), except for the Korean market: +10°C to +45°C (+50°F to +113°F)
External power operation	AC adapter 90–260 V AC, 50/60 Hz or 12 V from a vehicle (cable with a standard plug, optional)
Power management	Automatic power-off functionality, user configurable between 5 minutes, 20 minutes, and no automatic shutdown
Environmental data	
Operating temperature range	–15°C to +50°C (+5°F to +122°F)
Storage temperature range	–40 to +70°C (–40 to +158°F)
Humidity (operating and storage)	IEC 60068-2-30 / 24 hours, 95% relative humidity, 25–40°C (77–104°F) / 2 cycles

Environmental data	
EMC	<ul style="list-style-type: none"> • ETSI EN 301 489-1 (radio) • ETSI EN 301 489-17 • EN 61000-6-2 (Immunity) • EN 61000-6-3 (Emission) • FCC 47 CFR Part 15 Class B (Emission) • ICES-003
Radio spectrum	<ul style="list-style-type: none"> • ETSI EN 300 328 • FCC Part 15.247 • RSS-247 Issue 2
Encapsulation	IP 54 (IEC 60529)
Shock	25 g (IEC 60068-2-29)
Vibration	2 g (IEC 60068-2-6)
Safety	EN/UL/CSA/PSE 60950-1
Ergonomics	The viewfinder plus the 120° rotating optical block allow you to point the camera in multiple directions while maintaining a comfortable position
Physical data	
Weight	1.9 kg (4.3 lb.)
Camera size, excl. lens (L x W x H)	167.2 mm x 204.5 mm x 188.3 mm (6.6 in. x 8.0 in. x 7.4 in.)
Tripod mounting	UNC ¼"-20
Housing material	Magnesium
Warranty information	
Warranty	<ul style="list-style-type: none"> • 2 years parts and labor coverage on the camera • 5 years coverage on the battery • 10 years coverage on the detector – the most vital part of the whole camera
Shipping information	
List of contents	<ul style="list-style-type: none"> • Infrared camera with lens • Battery (2 ea.) • Battery charger • Bluetooth headset • Calibration certificate • FLIR Tools+ license card • FLIR T10xx SC kit (in separate hard transport case): <ul style="list-style-type: none"> ◦ High-speed interface ◦ USB cable (USB 3), 3 m (10 ft.) ◦ Digital I/O connector ◦ FLIR ResearchIR Max license card ◦ Printed documentation • Hard transport case • HDMI-HDMI cable • Lens cap • Memory card • Neck strap • Power supply, including multi-plugs • Printed documentation • USB cable, Std A to Micro-B
EAN-13	7332558010310
UPC-12	845188010959
Country of origin	Sweden

Supplies & accessories:

- T199064; IR lens f=36mm (28°) with case
- T199065; Close-up lens 3x (51 micron) with case
- T199066; IR lens f=21.2mm (45°) with case
- T199077; IR lens f=83.4mm (12°) with case
- T910814; Power supply, incl. multi plugs
- T198126; Battery charger, incl. power supply with multi plugs T6xx
- T199364ACC; Battery Li-ion 3.65 V, 8.5 Ah, 32 Wh
- T911650ACC; Memory card SD Card 8 GB
- T198509; Cigarette lighter adapter kit, 12 VDC, 1.2 m/3.9 ft.
- T910930ACC; HDMI type C to DVI cable 1.5 m
- T910891ACC; HDMI type C to HDMI type A cable 1.5 m
- 72500-0002; FLIR T10xx SC kit
- T198497; Large eyecup
- T197771ACC; Bluetooth Headset
- T911093; Tool belt
- T198533; USB cable Std A <-> Micro B
- T198586; FLIR Reporter Professional (license only)
- T198584; FLIR Tools
- T198583; FLIR Tools+ (download card incl. license key)
- DSW-10000; FLIR IR Camera Player
- APP-10002; FLIR Tools Mobile (Android Application)
- APP-10003; FLIR Tools Mobile (iPad/iPhone Application)
- APP-10004; FLIR Tools (MacOS Application)
- T198697; FLIR ResearchIR Max + HSDR 4 (hardware sec. dev.)
- T199014; FLIR ResearchIR Max + HSDR 4 (printed license key)
- T199044; FLIR ResearchIR Max + HSDR 4 Upgrade (printed license key)
- T198696; FLIR ResearchIR Max 4 (hardware sec. dev.)
- T199013; FLIR ResearchIR Max 4 (printed license key)
- T199043; FLIR ResearchIR Max 4 Upgrade (printed license key)
- T198731; FLIR ResearchIR Standard 4 (hardware sec. dev.)
- T199012; FLIR ResearchIR Standard 4 (printed license key)
- T199042; FLIR ResearchIR Standard 4 Upgrade (printed license key)
- T199233; FLIR Atlas SDK for .NET
- T199234; FLIR Atlas SDK for MATLAB

30.15 FLIR T1030sc 45°

P/N: 72501-0203

Rev.: 46154

General description	
<p>The FLIR T1030sc is designed for the expert requiring the highest performance and the latest technology available. The camera combines excellent ergonomics and feature-rich flexibility with superior image quality at an infrared resolution of 1024 × 768 pixels. High accuracy and sensitivity together with radiometric recording and streaming options make the FLIR T1030sc well suited for advanced research and development.</p>	
<p>Benefits:</p> <ul style="list-style-type: none"> • Tailor made for research and development: The FLIR T1030sc has high accuracy and high sensitivity, to accurately measure the smallest temperature differences. With real-time radiometric recording, it is possible to capture fast events on the camera's SD card for further analysis by the supplied analysis software. • Flexible and feature rich: A wide variety of measuring and analysis functions make the FLIR T1030sc flexible for your every need. Two programmable buttons provide easy access to favorite functions. • Highest performance with the latest technology: The FLIR T1030sc is equipped with the innovative Multi Spectral Dynamic Imaging (MSX) feature, which produces an image richer in detail than ever before. With its continuous autofocus, the FLIR T1030sc is a fully automatic infrared camera. • Support for UltraMax: When enabling UltraMax in the camera, the resolution of images can be substantially enhanced when importing the images into FLIR Tools. 	
Imaging and optical data	
IR resolution	1024 × 768 pixels
MSX resolution	1024 × 768 pixels
UltraMax	Yes
Thermal sensitivity/NETD	<20 mK @ +30°C (+86°F)
Field of view (FOV)	45° × 34°
Minimum IR focus distance	0.2 m (0.66 ft.)
Minimum IR–visual alignment distance	0.5 m (1.64 ft.)
Focal length	21.2 mm (0.83 in.)
Spatial resolution (IFOV)	0.80 mrad
Lens identification	Automatic
F-number	1.1
Image frequency	30 Hz
Focus	One shot or manual
Digital zoom	1–8× continuous
Digital image enhancement	Adaptive digital noise reduction
Detector data	
Detector type	Focal plane array (FPA), uncooled microbolometer
Spectral range	7.5–14 μm
Detector pitch	17 μm
Time constant	< 10 ms
Image presentation	
Display	Built-in touch screen, 4.3 in. wide screen LCD, 800 × 480 pixels
Display type	Capacitive touch screen
Auto orientation	Automatic landscape or portrait

Image presentation	
Viewfinder	Built-in 800 × 480 pixels
Automatic image adjustment	Continuous, histogram based
Automatic image adjustment, type	Standard or histogram based on the image content
Manual image adjustment	Linear based, possible to adjust level/span/max./min.

Image presentation modes	
Image modes	Thermal, thermal MSX, picture in picture, digital camera
Infrared image	Full color infrared image
Visual image	Full color visual image
Multi Spectral Dynamic Imaging (MSX)	Thermal image with enhanced detail presentation
Picture in Picture	Resizable and movable infrared area on the visual image
Gallery	<ul style="list-style-type: none"> Review thumbnail/full image on the camera Edit measurements/palettes/image modes on the camera

Measurement		
Object temperature range		Accuracy
-40 to +150°C (-40 to +302°F)	-40 to +5°C (-40 to +41°F)	±2°C (±3.6°F)
	+5 to +100°C (+41 to +212°F)	±1°C (±1.8°F)
	+100 to +150°C (+212 to +302°F)	±1%
0 to +650°C (+32 to +1202°F)	0 to +100°C (+32 to +212°F)	±2°C (±3.6°F)
	+100 to +650°C (+212 to +1202°F)	±2%
+300 to +2000°C (+572 to +3632°F)	+300 to +2000°C (+572 to +3632°F)	±2%

**NOTE**

For HSI use, above 30 Hz frame rate, the typical accuracy will be ±2.5°C (±4.5°F), or 2.5% of reading @ 25°C (77°F).

Measurement analysis	
Spotmeter	10
Area	5 + 5 areas (boxes and circles) with max./min./average
Profile	1 line profile with max./min. temperature
Automatic hot/cold detection	Auto hot or cold spotmeter markers within the area and profile
Measurement presets	No measurements, Center spot, Hot spot, Cold spot, User preset 1, User preset 2
User presets	The user can select and combine measurements from any number of spots/boxes/circles/profiles/delta
Difference temperature	Delta temperature between the measurement functions and the reference temperature
Reference temperature	Manually set using the difference temperature

Measurement analysis	
Atmospheric transmission correction	Automatic, based on the inputs for distance, atmospheric temperature, and relative humidity
Optics transmission correction	Automatic, based on signals from internal sensors
Emissivity correction	Variable from 0.01 to 1.0 or selected from the materials list
Reflected apparent temperature correction	Automatic, based on the input of the reflected temperature
External optics/windows correction	Automatic, based on the inputs of the window transmission and temperature
Measurement corrections	Emissivity, reflected temperature, relative humidity, atmospheric temperature, object distance, external infrared window compensation
Colors (palettes)	Iron, Rainbow, Rainbow HC, White hot, Black hot, Arctic, Lava
Alarm	
Color alarm (isotherm)	<ul style="list-style-type: none"> • Above • Below • Interval • Condensation (moisture/humidity/dewpoint) • Insulation
Measurement function alarm	Audible/visual alarms (above/below) on any selected measurement function
Set-up	
Set-up commands	Define user presets, Save options, Programmable button, Reset options, Set up camera, Wi-Fi, GPS & compass, Bluetooth, Language, Time & units, Camera information
Languages	Arabic, Czech, Danish, Dutch, English, Finnish, French, German, Greek, Hungarian, Italian, Japanese, Korean, Norwegian, Polish, Portuguese, Russian, simplified Chinese, Swedish, traditional Chinese, Turkish
Service functions	
Camera software update	Use PC software FLIR Tools
Storage of images	
Image storage	Standard JPEG, including digital image and measurement data, on a memory card
Storage media	Removable media SD or SDHC card. Class 10 or better recommended
Image storage mode	<ul style="list-style-type: none"> • Simultaneous storage of thermal and digital images in the same JPEG file • Option to store a digital photo as a separate JPEG file
Time lapse	15 seconds to 24 hours
File formats	<ul style="list-style-type: none"> • Standard JPEG, measurement data included • CSQ, measurement data included
File formats, visual	Standard JPEG, automatically associated with the corresponding thermal image
Image annotations	
Voice	60 seconds (via Bluetooth) stored with the image
Text	Add table, select between predefined templates

Image annotations	
Image description	Add short note (stored in the JPEG exif tag)
Sketch	<ul style="list-style-type: none"> • Draw on the thermal/digital image or add pre-defined stamps • Separate PC software with extensive report generation
METERLiNK	Wireless connection (Bluetooth) to: FLIR meters with METERLiNK
Geographic Information System	
GPS	Location data automatically added to every image from the built-in GPS
Compass	Camera direction automatically added to every image
Video recording in camera	
Radiometric IR-video recording	Real-time radiometric recording (RTRR) to the memory card
Non-radiometric IR-video recording	H.264 to the memory card
Visual video recording	H.264 to the memory card
Video streaming	
Radiometric IR-video streaming	<ul style="list-style-type: none"> • Full dynamic un-compressed 120 Hz 16-bit full frame (2 Gbit) to a PC using an HSI box • Real-time radiometric streaming 30 Hz (RTRS) via USB
Non-radiometric IR-video streaming	<ul style="list-style-type: none"> • H.264 video using Wi-Fi • H.264 video using USB
Visual video streaming	<ul style="list-style-type: none"> • H.264 video using Wi-Fi • H.264 video using USB
Windowing	<ul style="list-style-type: none"> • 30 Hz: 1024 × 768 (full image height) • Based on 30 Hz: 120 Hz windowing 1024 × 192 (¼ of full image height), for range -40 to +150°C (-40 to +302°F) • 120 Hz: 1024 × 768 (full image height) • Based on 120 Hz: 240 Hz windowing 1024 × 384 (½ of full image height), for range 0 to +650°C (+32 to +1202°F) and range +300 to +2000°C (+572 to +3632°F)
Digital camera	
Built-in digital camera	5 Mpixel with LED light
Digital camera	Field of view adapts to the infrared lens
Video lamp	Built-in LED light
Laser pointer	
Laser	Activated by a dedicated button
Laser alignment	Position is automatically displayed on the infrared image
Laser classification	Class 2
Laser type	Semiconductor AlGaInP diode laser, 1 mW, 635 nm (red)

Data communication interfaces	
Interfaces	USB Micro-B, Bluetooth, Wi-Fi, HDMI, USB3 Vision via HSI box
METERLiNK/Bluetooth	Communication with headset and external sensors
Wi-Fi	Infrastructure (network) or AP
SD Card	One card slot for removable SD memory cards
Audio	Microphone headset via Bluetooth for the voice annotation of images
USB	
USB	USB Micro-B: data transfer to and from a PC, uncompressed colorized video
USB, standard	<ul style="list-style-type: none"> • USB 2.0 High Speed • USB Micro-B connector • USB3 Vision via HSI box
Video	
Video out	<ul style="list-style-type: none"> • HDMI 640 × 480 • HDMI 1280 × 720 • DVI 640 × 480 • DVI 800 × 600
Video, connector type	HDMI type C
Radio	
Wi-Fi	<ul style="list-style-type: none"> • Standard: 802.11 b/g/n • Frequency range: 2412–2462 MHz • Max. output power: 15 dBm
METERLiNK/Bluetooth	Frequency range: 2402–2480 MHz, supports 2.1 and 4.0
Antenna	Internal
Power system	
Battery type	Rechargeable Li ion battery
Battery operating time	>2.5 hours at 25°C (+68°F) and typical use
Charging system	In camera (AC adapter or 12 V from a vehicle) or two-bay charger
Charging time	2.5 hours to 90% capacity, charging status indicated by LEDs
Charging temperature	0°C to +45°C (+32°F to +113°F), except for the Korean market: +10°C to +45°C (+50°F to +113°F)
External power operation	AC adapter 90–260 V AC, 50/60 Hz or 12 V from a vehicle (cable with a standard plug, optional)
Power management	Automatic power-off functionality, user configurable between 5 minutes, 20 minutes, and no automatic shutdown
Environmental data	
Operating temperature range	–15°C to +50°C (+5°F to +122°F)
Storage temperature range	–40 to +70°C (–40 to +158°F)
Humidity (operating and storage)	IEC 60068-2-30 / 24 hours, 95% relative humidity, 25–40°C (77–104°F) / 2 cycles

Environmental data	
EMC	<ul style="list-style-type: none"> • ETSI EN 301 489-1 (radio) • ETSI EN 301 489-17 • EN 61000-6-2 (Immunity) • EN 61000-6-3 (Emission) • FCC 47 CFR Part 15 Class B (Emission) • ICES-003
Radio spectrum	<ul style="list-style-type: none"> • ETSI EN 300 328 • FCC Part 15.247 • RSS-247 Issue 2
Encapsulation	IP 54 (IEC 60529)
Shock	25 g (IEC 60068-2-29)
Vibration	2 g (IEC 60068-2-6)
Safety	EN/UL/CSA/PSE 60950-1
Ergonomics	The viewfinder plus the 120° rotating optical block allow you to point the camera in multiple directions while maintaining a comfortable position
Physical data	
Weight	2.0 kg (4.3 lb.)
Camera size, excl. lens (L x W x H)	167.2 mm x 204.5 mm x 188.3 mm (6.6 in. x 8.0 in. x 7.4 in.)
Tripod mounting	UNC ¼"-20
Housing material	Magnesium
Warranty information	
Warranty	<ul style="list-style-type: none"> • 2 years parts and labor coverage on the camera • 5 years coverage on the battery • 10 years coverage on the detector – the most vital part of the whole camera
Shipping information	
List of contents	<ul style="list-style-type: none"> • Infrared camera with lens • Battery (2 ea.) • Battery charger • Bluetooth headset • Calibration certificate • FLIR Tools+ license card • FLIR T10xx SC kit (in separate hard transport case): <ul style="list-style-type: none"> ◦ High-speed interface ◦ USB cable (USB 3), 3 m (10 ft.) ◦ Digital I/O connector ◦ FLIR ResearchIR Max license card ◦ Printed documentation • Hard transport case • HDMI-HDMI cable • Lens cap • Memory card • Neck strap • Power supply, including multi-plugs • Printed documentation • USB cable, Std A to Micro-B
EAN-13	7332558010327
UPC-12	845188010966
Country of origin	Sweden

Supplies & accessories:

- T199064; IR lens f=36mm (28°) with case
- T199066; IR lens f=21.2mm (45°) with case
- T199077; IR lens f=83.4mm (12°) with case
- T910814; Power supply, incl. multi plugs
- T198126; Battery charger, incl. power supply with multi plugs T6xx
- T199364ACC; Battery Li-ion 3.65 V, 8.5 Ah, 32 Wh
- T911650ACC; Memory card SD Card 8 GB
- T198509; Cigarette lighter adapter kit, 12 VDC, 1.2 m/3.9 ft.
- T910930ACC; HDMI type C to DVI cable 1.5 m
- T910891ACC; HDMI type C to HDMI type A cable 1.5 m
- 72500-0002; FLIR T10xx SC kit
- T198497; Large eyecup
- T197771ACC; Bluetooth Headset
- T911093; Tool belt
- T198533; USB cable Std A <-> Micro B
- T198586; FLIR Reporter Professional (license only)
- T198584; FLIR Tools
- T198583; FLIR Tools+ (download card incl. license key)
- DSW-10000; FLIR IR Camera Player
- APP-10002; FLIR Tools Mobile (Android Application)
- APP-10003; FLIR Tools Mobile (iPad/iPhone Application)
- APP-10004; FLIR Tools (MacOS Application)
- T198697; FLIR ResearchIR Max + HSDR 4 (hardware sec. dev.)
- T199014; FLIR ResearchIR Max + HSDR 4 (printed license key)
- T199044; FLIR ResearchIR Max + HSDR 4 Upgrade (printed license key)
- T198696; FLIR ResearchIR Max 4 (hardware sec. dev.)
- T199013; FLIR ResearchIR Max 4 (printed license key)
- T199043; FLIR ResearchIR Max 4 Upgrade (printed license key)
- T198731; FLIR ResearchIR Standard 4 (hardware sec. dev.)
- T199012; FLIR ResearchIR Standard 4 (printed license key)
- T199042; FLIR ResearchIR Standard 4 Upgrade (printed license key)
- T199233; FLIR Atlas SDK for .NET
- T199234; FLIR Atlas SDK for MATLAB

30.16 FLIR T1040 12°

P/N: 72501-0301

Rev.: 46148

General description	
The FLIR T1040 is designed for the expert requiring the highest performance and the latest technology available. The camera combines excellent ergonomics and feature-rich flexibility with superior image quality at an infrared resolution of 1024 × 768 pixels.	
Benefits:	
<ul style="list-style-type: none"> • Flexible and feature rich: A wide variety of measuring and analysis functions make the FLIR T1040 flexible for your every need. Two programmable buttons provide easy access to favorite functions. • Highest performance with the latest technology: The FLIR T1040 is equipped with the innovative Multi Spectral Dynamic Imaging (MSX) feature, which produces an image richer in detail than ever before. With its continuous autofocus, the FLIR T1040 is a fully automatic infrared camera. • Support for UltraMax: When enabling UltraMax in the camera, the resolution of images can be substantially enhanced when importing the images into FLIR Tools. 	
Imaging and optical data	
IR resolution	1024 × 768 pixels
MSX resolution	1024 × 768 pixels
UltraMax	Yes
Thermal sensitivity/NETD	<20 mK @ +30°C (+86°F)
Field of view (FOV)	12° × 9°
Minimum IR focus distance	1.3 m (4.26 ft.)
Minimum IR–visual alignment distance	1.3 m (4.26 ft.)
Focal length	83.4 mm (3.28 in.)
Spatial resolution (IFOV)	0.20 mrad
Lens identification	Automatic
F-number	1.2
Image frequency	30 Hz
Focus	One shot or manual
Digital zoom	1–8× continuous
Digital image enhancement	Adaptive digital noise reduction
Detector data	
Detector type	Focal plane array (FPA), uncooled microbolometer
Spectral range	7.5–14 μm
Detector pitch	17 μm
Image presentation	
Display	Built-in touch screen, 4.3 in. wide screen LCD, 800 × 480 pixels
Display type	Capacitive touch screen
Auto orientation	Automatic landscape or portrait
Viewfinder	Built-in 800 × 480 pixels
Automatic image adjustment	Continuous, histogram based
Automatic image adjustment, type	Standard or histogram based on the image content
Manual image adjustment	Linear based, possible to adjust level/span/max./min.

Image presentation modes	
Image modes	Thermal, thermal MSX, picture in picture, digital camera
Infrared image	Full color infrared image
Visual image	Full color visual image
Multi Spectral Dynamic Imaging (MSX)	Thermal image with enhanced detail presentation
Picture in Picture	Resizable and movable infrared area on the visual image
Gallery	<ul style="list-style-type: none"> Review thumbnail/full image on the camera Edit measurements/palettes/image modes on the camera

Measurement		
Object temperature range		Accuracy
-40 to +150°C (-40 to +302°F)	-40 to +5°C (-40 to +41°F)	±2°C (±3.6°F)
	+5 to +100°C (+41 to +212°F)	±1°C (±1.8°F)
	+100 to +150°C (+212 to +302°F)	±1%
0 to +650°C (+32 to +1202°F)	0 to +100°C (+32 to +212°F)	±2°C (±3.6°F)
	+100 to +650°C (+212 to +1202°F)	±2%
+300 to +2000°C (+572 to +3632°F)	+300 to +2000°C (+572 to +3632°F)	±2%

**NOTE**

For HSI use, above 30 Hz frame rate, the typical accuracy will be ±2.5°C (±4.5°F), or 2.5% of reading @ 25°C (77°F).

Measurement analysis	
Spotmeter	10
Area	5 + 5 areas (boxes and circles) with max./min./average
Profile	1 line profile with max./min. temperature
Automatic hot/cold detection	Auto hot or cold spotmeter markers within the area and profile
Measurement presets	No measurements, Center spot, Hot spot, Cold spot, User preset 1, User preset 2
User presets	The user can select and combine measurements from any number of spots/boxes/circles/profiles/delta
Difference temperature	Delta temperature between the measurement functions and the reference temperature
Reference temperature	Manually set using the difference temperature
Atmospheric transmission correction	Automatic, based on the inputs for distance, atmospheric temperature, and relative humidity
Optics transmission correction	Automatic, based on signals from internal sensors
Emissivity correction	Variable from 0.01 to 1.0 or selected from the materials list
Reflected apparent temperature correction	Automatic, based on the input of the reflected temperature
External optics/windows correction	Automatic, based on the inputs of the window transmission and temperature

Measurement analysis	
Measurement corrections	Emissivity, reflected temperature, relative humidity, atmospheric temperature, object distance, external infrared window compensation
Colors (palettes)	Iron, Rainbow, Rainbow HC, White hot, Black hot, Arctic, Lava
Alarm	
Color alarm (isotherm)	<ul style="list-style-type: none"> • Above • Below • Interval • Condensation (moisture/humidity/dewpoint) • Insulation
Measurement function alarm	Audible/visual alarms (above/below) on any selected measurement function
Set-up	
Set-up commands	Define user presets, Save options, Programmable button, Reset options, Set up camera, Wi-Fi, GPS & compass, Bluetooth, Language, Time & units, Camera information
Languages	Arabic, Czech, Danish, Dutch, English, Finnish, French, German, Greek, Hungarian, Italian, Japanese, Korean, Norwegian, Polish, Portuguese, Russian, simplified Chinese, Swedish, traditional Chinese, Turkish
Service functions	
Camera software update	Use PC software FLIR Tools
Storage of images	
Image storage	Standard JPEG, including digital image and measurement data, on a memory card
Storage media	Removable media SD or SDHC card. Class 10 or better recommended
Image storage mode	<ul style="list-style-type: none"> • Simultaneous storage of thermal and digital images in the same JPEG file • Option to store a digital photo as a separate JPEG file
Time lapse	15 seconds to 24 hours
File formats	<ul style="list-style-type: none"> • Standard JPEG, measurement data included • CSQ, measurement data included
File formats, visual	Standard JPEG, automatically associated with the corresponding thermal image
Image annotations	
Voice	60 seconds (via Bluetooth) stored with the image
Text	Add table, select between predefined templates
Image description	Add short note (stored in the JPEG exif tag)
Sketch	<ul style="list-style-type: none"> • Draw on the thermal/digital image or add predefined stamps • Separate PC software with extensive report generation
METERLiNK	Wireless connection (Bluetooth) to: FLIR meters with METERLiNK

Geographic Information System	
GPS	Location data automatically added to every image from the built-in GPS
Compass	Camera direction automatically added to every image
Video recording in camera	
Radiometric IR-video recording	Real-time radiometric recording (RTRR) to the memory card
Non-radiometric IR-video recording	H.264 to the memory card
Visual video recording	H.264 to the memory card
Video streaming	
Radiometric IR-video streaming	Real-time radiometric streaming (RTRS) via USB
Non-radiometric IR-video streaming	<ul style="list-style-type: none"> • H.264 video using Wi-Fi • H.264 video using USB
Visual video streaming	<ul style="list-style-type: none"> • H.264 video using Wi-Fi • H.264 video using USB
Digital camera	
Built-in digital camera	5 Mpixel with LED light
Digital camera	Field of view adapts to the infrared lens
Video lamp	Built-in LED light
Laser pointer	
Laser	Activated by a dedicated button
Laser alignment	Position is automatically displayed on the infrared image
Laser classification	Class 2
Laser type	Semiconductor AlGaInP diode laser, 1 mW, 635 nm (red)
Data communication interfaces	
Interfaces	USB Micro-B, Bluetooth, Wi-Fi, HDMI
METERLiNK/Bluetooth	Communication with headset and external sensors
Wi-Fi	Infrastructure (network) or AP
SD Card	One card slot for removable SD memory cards
Audio	Microphone headset via Bluetooth for the voice annotation of images
USB	
USB	USB Micro-B: data transfer to and from a PC, uncompressed colorized video
USB, standard	<ul style="list-style-type: none"> • USB 2.0 High Speed • USB Micro-B connector
Video	
Video out	<ul style="list-style-type: none"> • HDMI 640 × 480 • HDMI 1280 × 720 • DVI 640 × 480 • DVI 800 × 600
Video, connector type	HDMI type C

Radio	
Wi-Fi	<ul style="list-style-type: none"> • Standard: 802.11 b/g/n • Frequency range: 2412–2462 MHz • Max. output power: 15 dBm
METERLiNK/Bluetooth	Frequency range: 2402–2480 MHz, supports 2.1 and 4.0
Antenna	Internal
Power system	
Battery type	Rechargeable Li ion battery
Battery operating time	>2.5 hours at 25°C (+68°F) and typical use
Charging system	In camera (AC adapter or 12 V from a vehicle) or two-bay charger
Charging time	2.5 hours to 90% capacity, charging status indicated by LEDs
Charging temperature	0°C to +45°C (+32°F to +113°F), except for the Korean market: +10°C to +45°C (+50°F to +113°F)
External power operation	AC adapter 90–260 V AC, 50/60 Hz or 12 V from a vehicle (cable with a standard plug, optional)
Power management	Automatic power-off functionality, user configurable between 5 minutes, 20 minutes, and no automatic shutdown
Environmental data	
Operating temperature range	–15°C to +50°C (+5°F to +122°F)
Storage temperature range	–40 to +70°C (–40 to +158°F)
Humidity (operating and storage)	IEC 60068-2-30 / 24 hours, 95% relative humidity, 25–40°C (77–104°F) / 2 cycles
EMC	<ul style="list-style-type: none"> • ETSI EN 301 489-1 (radio) • ETSI EN 301 489-17 • EN 61000-6-2 (Immunity) • EN 61000-6-3 (Emission) • FCC 47 CFR Part 15 Class B (Emission) • ICES-003
Radio spectrum	<ul style="list-style-type: none"> • ETSI EN 300 328 • FCC Part 15.247 • RSS-247 Issue 2
Encapsulation	IP 54 (IEC 60529)
Shock	25 g (IEC 60068-2-29)
Vibration	2 g (IEC 60068-2-6)
Safety	EN/UL/CSA/PSE 60950-1
Ergonomics	The viewfinder plus the 120° rotating optical block allow you to point the camera in multiple directions while maintaining a comfortable position
Physical data	
Weight	2.1 kg (4.6 lb.)
Camera size, excl. lens (L × W × H)	167.2 mm × 204.5 mm × 188.3 mm (6.6 in. × 8.0 in. × 7.4 in.)
Tripod mounting	UNC ¼"-20
Housing material	Magnesium

Warranty information	
Warranty	<ul style="list-style-type: none"> • 2 years parts and labor coverage on the camera • 5 years coverage on the battery • 10 years coverage on the detector – the most vital part of the whole camera
Shipping information	
List of contents	<ul style="list-style-type: none"> • Infrared camera with lens • Battery (2 ea.) • Battery charger • Bluetooth headset • Calibration certificate • FLIR Tools+ license card • Hard transport case • HDMI-HDMI cable • Lens cap • Memory card • Neck strap • Power supply, including multi-plugs • Printed documentation • USB cable, Std A to Micro-B
EAN-13	7332558010389
UPC-12	845188011031
Country of origin	Sweden

Supplies & accessories:

- T199064; IR lens f=36mm (28°) with case
- T199066; IR lens f=21.2mm (45°) with case
- T199077; IR lens f=83.4mm (12°) with case
- T910814; Power supply, incl. multi plugs
- T198126; Battery charger, incl. power supply with multi plugs T6xx
- T199364ACC; Battery Li-ion 3.65 V, 8.5 Ah, 32 Wh
- T911650ACC; Memory card SD Card 8 GB
- T198509; Cigarette lighter adapter kit, 12 VDC, 1.2 m/3.9 ft.
- T910930ACC; HDMI type C to DVI cable 1.5 m
- T910891ACC; HDMI type C to HDMI type A cable 1.5 m
- T198497; Large eyecup
- T197771ACC; Bluetooth Headset
- T911093; Tool belt
- T198533; USB cable Std A <-> Micro B
- T198586; FLIR Reporter Professional (license only)
- T198584; FLIR Tools
- T198583; FLIR Tools+ (download card incl. license key)
- DSW-10000; FLIR IR Camera Player
- APP-10002; FLIR Tools Mobile (Android Application)
- APP-10003; FLIR Tools Mobile (iPad/iPhone Application)
- APP-10004; FLIR Tools (MacOS Application)
- T199233; FLIR Atlas SDK for .NET
- T199234; FLIR Atlas SDK for MATLAB

30.17 FLIR T1040 28°

P/N: 72501-0302

Rev.: 46149

General description	
The FLIR T1040 is designed for the expert requiring the highest performance and the latest technology available. The camera combines excellent ergonomics and feature-rich flexibility with superior image quality at an infrared resolution of 1024 × 768 pixels.	
Benefits:	
<ul style="list-style-type: none"> • Flexible and feature rich: A wide variety of measuring and analysis functions make the FLIR T1040 flexible for your every need. Two programmable buttons provide easy access to favorite functions. • Highest performance with the latest technology: The FLIR T1040 is equipped with the innovative Multi Spectral Dynamic Imaging (MSX) feature, which produces an image richer in detail than ever before. With its continuous autofocus, the FLIR T1040 is a fully automatic infrared camera. • Support for UltraMax: When enabling UltraMax in the camera, the resolution of images can be substantially enhanced when importing the images into FLIR Tools. 	
Imaging and optical data	
IR resolution	1024 × 768 pixels
MSX resolution	1024 × 768 pixels
UltraMax	Yes
Thermal sensitivity/NETD	<20 mK @ +30°C (+86°F)
Field of view (FOV)	28° × 21°
Minimum IR focus distance	0.4 m (1.32 ft.)
Minimum IR–visual alignment distance	0.4 m (1.32 ft.)
Focal length	36 mm (1.42 in.)
Spatial resolution (IFOV)	0.47 mrad
Lens identification	Automatic
F-number	1.15
Image frequency	30 Hz
Focus	One shot or manual
Digital zoom	1–8× continuous
Digital image enhancement	Adaptive digital noise reduction
Detector data	
Detector type	Focal plane array (FPA), uncooled microbolometer
Spectral range	7.5–14 μm
Detector pitch	17 μm
Image presentation	
Display	Built-in touch screen, 4.3 in. wide screen LCD, 800 × 480 pixels
Display type	Capacitive touch screen
Auto orientation	Automatic landscape or portrait
Viewfinder	Built-in 800 × 480 pixels
Automatic image adjustment	Continuous, histogram based
Automatic image adjustment, type	Standard or histogram based on the image content
Manual image adjustment	Linear based, possible to adjust level/span/max./min.

Image presentation modes	
Image modes	Thermal, thermal MSX, picture in picture, digital camera
Infrared image	Full color infrared image
Visual image	Full color visual image
Multi Spectral Dynamic Imaging (MSX)	Thermal image with enhanced detail presentation
Picture in Picture	Resizable and movable infrared area on the visual image
Gallery	<ul style="list-style-type: none"> Review thumbnail/full image on the camera Edit measurements/palettes/image modes on the camera

Measurement		
Object temperature range		Accuracy
-40 to +150°C (-40 to +302°F)	-40 to +5°C (-40 to +41°F)	±2°C (±3.6°F)
	+5 to +100°C (+41 to +212°F)	±1°C (±1.8°F)
	+100 to +150°C (+212 to +302°F)	±1%
0 to +650°C (+32 to +1202°F)	0 to +100°C (+32 to +212°F)	±2°C (±3.6°F)
	+100 to +650°C (+212 to +1202°F)	±2%
+300 to +2000°C (+572 to +3632°F)	+300 to +2000°C (+572 to +3632°F)	±2%

**NOTE**

For HSI use, above 30 Hz frame rate, the typical accuracy will be ±2.5°C (±4.5°F), or 2.5% of reading @ 25°C (77°F).

Measurement analysis	
Spotmeter	10
Area	5 + 5 areas (boxes and circles) with max./min./average
Profile	1 line profile with max./min. temperature
Automatic hot/cold detection	Auto hot or cold spotmeter markers within the area and profile
Measurement presets	No measurements, Center spot, Hot spot, Cold spot, User preset 1, User preset 2
User presets	The user can select and combine measurements from any number of spots/boxes/circles/profiles/delta
Difference temperature	Delta temperature between the measurement functions and the reference temperature
Reference temperature	Manually set using the difference temperature
Atmospheric transmission correction	Automatic, based on the inputs for distance, atmospheric temperature, and relative humidity
Optics transmission correction	Automatic, based on signals from internal sensors
Emissivity correction	Variable from 0.01 to 1.0 or selected from the materials list
Reflected apparent temperature correction	Automatic, based on the input of the reflected temperature
External optics/windows correction	Automatic, based on the inputs of the window transmission and temperature

Measurement analysis	
Measurement corrections	Emissivity, reflected temperature, relative humidity, atmospheric temperature, object distance, external infrared window compensation
Colors (palettes)	Iron, Rainbow, Rainbow HC, White hot, Black hot, Arctic, Lava
Alarm	
Color alarm (isotherm)	<ul style="list-style-type: none"> • Above • Below • Interval • Condensation (moisture/humidity/dewpoint) • Insulation
Measurement function alarm	Audible/visual alarms (above/below) on any selected measurement function
Set-up	
Set-up commands	Define user presets, Save options, Programmable button, Reset options, Set up camera, Wi-Fi, GPS & compass, Bluetooth, Language, Time & units, Camera information
Languages	Arabic, Czech, Danish, Dutch, English, Finnish, French, German, Greek, Hungarian, Italian, Japanese, Korean, Norwegian, Polish, Portuguese, Russian, simplified Chinese, Swedish, traditional Chinese, Turkish
Service functions	
Camera software update	Use PC software FLIR Tools
Storage of images	
Image storage	Standard JPEG, including digital image and measurement data, on a memory card
Storage media	Removable media SD or SDHC card. Class 10 or better recommended
Image storage mode	<ul style="list-style-type: none"> • Simultaneous storage of thermal and digital images in the same JPEG file • Option to store a digital photo as a separate JPEG file
Time lapse	15 seconds to 24 hours
File formats	<ul style="list-style-type: none"> • Standard JPEG, measurement data included • CSQ, measurement data included
File formats, visual	Standard JPEG, automatically associated with the corresponding thermal image
Image annotations	
Voice	60 seconds (via Bluetooth) stored with the image
Text	Add table, select between predefined templates
Image description	Add short note (stored in the JPEG exif tag)
Sketch	<ul style="list-style-type: none"> • Draw on the thermal/digital image or add predefined stamps • Separate PC software with extensive report generation
METERLiNK	Wireless connection (Bluetooth) to: FLIR meters with METERLiNK

Geographic Information System	
GPS	Location data automatically added to every image from the built-in GPS
Compass	Camera direction automatically added to every image
Video recording in camera	
Radiometric IR-video recording	Real-time radiometric recording (RTRR) to the memory card
Non-radiometric IR-video recording	H.264 to the memory card
Visual video recording	H.264 to the memory card
Video streaming	
Radiometric IR-video streaming	Real-time radiometric streaming (RTRS) via USB
Non-radiometric IR-video streaming	<ul style="list-style-type: none"> • H.264 video using Wi-Fi • H.264 video using USB
Visual video streaming	<ul style="list-style-type: none"> • H.264 video using Wi-Fi • H.264 video using USB
Digital camera	
Built-in digital camera	5 Mpixel with LED light
Digital camera	Field of view adapts to the infrared lens
Video lamp	Built-in LED light
Laser pointer	
Laser	Activated by a dedicated button
Laser alignment	Position is automatically displayed on the infrared image
Laser classification	Class 2
Laser type	Semiconductor AlGaInP diode laser, 1 mW, 635 nm (red)
Data communication interfaces	
Interfaces	USB Micro-B, Bluetooth, Wi-Fi, HDMI
METERLiNK/Bluetooth	Communication with headset and external sensors
Wi-Fi	Infrastructure (network) or AP
SD Card	One card slot for removable SD memory cards
Audio	Microphone headset via Bluetooth for the voice annotation of images
USB	
USB	USB Micro-B: data transfer to and from a PC, uncompressed colorized video
USB, standard	<ul style="list-style-type: none"> • USB 2.0 High Speed • USB Micro-B connector
Video	
Video out	<ul style="list-style-type: none"> • HDMI 640 × 480 • HDMI 1280 × 720 • DVI 640 × 480 • DVI 800 × 600
Video, connector type	HDMI type C

Radio	
Wi-Fi	<ul style="list-style-type: none"> Standard: 802.11 b/g/n Frequency range: 2412–2462 MHz Max. output power: 15 dBm
METERLiNK/Bluetooth	Frequency range: 2402–2480 MHz, supports 2.1 and 4.0
Antenna	Internal
Power system	
Battery type	Rechargeable Li ion battery
Battery operating time	>2.5 hours at 25°C (+68°F) and typical use
Charging system	In camera (AC adapter or 12 V from a vehicle) or two-bay charger
Charging time	2.5 hours to 90% capacity, charging status indicated by LEDs
Charging temperature	0°C to +45°C (+32°F to +113°F), except for the Korean market: +10°C to +45°C (+50°F to +113°F)
External power operation	AC adapter 90–260 V AC, 50/60 Hz or 12 V from a vehicle (cable with a standard plug, optional)
Power management	Automatic power-off functionality, user configurable between 5 minutes, 20 minutes, and no automatic shutdown
Environmental data	
Operating temperature range	–15°C to +50°C (+5°F to +122°F)
Storage temperature range	–40 to +70°C (–40 to +158°F)
Humidity (operating and storage)	IEC 60068-2-30 / 24 hours, 95% relative humidity, 25–40°C (77–104°F) / 2 cycles
EMC	<ul style="list-style-type: none"> ETSI EN 301 489-1 (radio) ETSI EN 301 489-17 EN 61000-6-2 (Immunity) EN 61000-6-3 (Emission) FCC 47 CFR Part 15 Class B (Emission) ICES-003
Radio spectrum	<ul style="list-style-type: none"> ETSI EN 300 328 FCC Part 15.247 RSS-247 Issue 2
Encapsulation	IP 54 (IEC 60529)
Shock	25 g (IEC 60068-2-29)
Vibration	2 g (IEC 60068-2-6)
Safety	EN/UL/CSA/PSE 60950-1
Ergonomics	The viewfinder plus the 120° rotating optical block allow you to point the camera in multiple directions while maintaining a comfortable position
Physical data	
Weight	1.9 kg (4.3 lb.)
Camera size, excl. lens (L × W × H)	167.2 mm × 204.5 mm × 188.3 mm (6.6 in. × 8.0 in. × 7.4 in.)
Tripod mounting	UNC ¼"-20
Housing material	Magnesium

Warranty information	
Warranty	<ul style="list-style-type: none"> • 2 years parts and labor coverage on the camera • 5 years coverage on the battery • 10 years coverage on the detector – the most vital part of the whole camera
Shipping information	
List of contents	<ul style="list-style-type: none"> • Infrared camera with lens • Battery (2 ea.) • Battery charger • Bluetooth headset • Calibration certificate • FLIR Tools+ license card • Hard transport case • HDMI-HDMI cable • Lens cap • Memory card • Neck strap • Power supply, including multi-plugs • Printed documentation • USB cable, Std A to Micro-B
EAN-13	7332558010396
UPC-12	845188011048
Country of origin	Sweden

Supplies & accessories:

- T199064; IR lens f=36mm (28°) with case
- T199065; Close-up lens 3x (51 micron) with case
- T199066; IR lens f=21.2mm (45°) with case
- T199077; IR lens f=83.4mm (12°) with case
- T910814; Power supply, incl. multi plugs
- T198126; Battery charger, incl. power supply with multi plugs T6xx
- T199364ACC; Battery Li-ion 3.65 V, 8.5 Ah, 32 Wh
- T911650ACC; Memory card SD Card 8 GB
- T198509; Cigarette lighter adapter kit, 12 VDC, 1.2 m/3.9 ft.
- T910930ACC; HDMI type C to DVI cable 1.5 m
- T910891ACC; HDMI type C to HDMI type A cable 1.5 m
- T198497; Large eyecup
- T197771ACC; Bluetooth Headset
- T911093; Tool belt
- T198533; USB cable Std A <-> Micro B
- T198586; FLIR Reporter Professional (license only)
- T198584; FLIR Tools
- T198583; FLIR Tools+ (download card incl. license key)
- DSW-10000; FLIR IR Camera Player
- APP-10002; FLIR Tools Mobile (Android Application)
- APP-10003; FLIR Tools Mobile (iPad/iPhone Application)
- APP-10004; FLIR Tools (MacOS Application)
- T199233; FLIR Atlas SDK for .NET
- T199234; FLIR Atlas SDK for MATLAB

30.18 FLIR T1040 45°

P/N: 72501-0303

Rev.: 46150

General description	
The FLIR T1040 is designed for the expert requiring the highest performance and the latest technology available. The camera combines excellent ergonomics and feature-rich flexibility with superior image quality at an infrared resolution of 1024 × 768 pixels.	
Benefits:	
<ul style="list-style-type: none"> • Flexible and feature rich: A wide variety of measuring and analysis functions make the FLIR T1040 flexible for your every need. Two programmable buttons provide easy access to favorite functions. • Highest performance with the latest technology: The FLIR T1040 is equipped with the innovative Multi Spectral Dynamic Imaging (MSX) feature, which produces an image richer in detail than ever before. With its continuous autofocus, the FLIR T1040 is a fully automatic infrared camera. • Support for UltraMax: When enabling UltraMax in the camera, the resolution of images can be substantially enhanced when importing the images into FLIR Tools. 	
Imaging and optical data	
IR resolution	1024 × 768 pixels
MSX resolution	1024 × 768 pixels
UltraMax	Yes
Thermal sensitivity/NETD	<20 mK @ +30°C (+86°F)
Field of view (FOV)	45° × 34°
Minimum IR focus distance	0.2 m (0.66 ft.)
Minimum IR–visual alignment distance	0.5 m (1.64 ft.)
Focal length	21.2 mm (0.83 in.)
Spatial resolution (IFOV)	0.80 mrad
Lens identification	Automatic
F-number	1.1
Image frequency	30 Hz
Focus	One shot or manual
Digital zoom	1–8× continuous
Digital image enhancement	Adaptive digital noise reduction
Detector data	
Detector type	Focal plane array (FPA), uncooled microbolometer
Spectral range	7.5–14 μm
Detector pitch	17 μm
Image presentation	
Display	Built-in touch screen, 4.3 in. wide screen LCD, 800 × 480 pixels
Display type	Capacitive touch screen
Auto orientation	Automatic landscape or portrait
Viewfinder	Built-in 800 × 480 pixels
Automatic image adjustment	Continuous, histogram based
Automatic image adjustment, type	Standard or histogram based on the image content
Manual image adjustment	Linear based, possible to adjust level/span/max./min.

Image presentation modes	
Image modes	Thermal, thermal MSX, picture in picture, digital camera
Infrared image	Full color infrared image
Visual image	Full color visual image
Multi Spectral Dynamic Imaging (MSX)	Thermal image with enhanced detail presentation
Picture in Picture	Resizable and movable infrared area on the visual image
Gallery	<ul style="list-style-type: none"> Review thumbnail/full image on the camera Edit measurements/palettes/image modes on the camera

Measurement		
Object temperature range		Accuracy
-40 to +150°C (-40 to +302°F)	-40 to +5°C (-40 to +41°F)	±2°C (±3.6°F)
	+5 to +100°C (+41 to +212°F)	±1°C (±1.8°F)
	+100 to +150°C (+212 to +302°F)	±1%
0 to +650°C (+32 to +1202°F)	0 to +100°C (+32 to +212°F)	±2°C (±3.6°F)
	+100 to +650°C (+212 to +1202°F)	±2%
+300 to +2000°C (+572 to +3632°F)	+300 to +2000°C (+572 to +3632°F)	±2%

**NOTE**

For HSI use, above 30 Hz frame rate, the typical accuracy will be ±2.5°C (±4.5°F), or 2.5% of reading @ 25°C (77°F).

Measurement analysis	
Spotmeter	10
Area	5 + 5 areas (boxes and circles) with max./min./average
Profile	1 line profile with max./min. temperature
Automatic hot/cold detection	Auto hot or cold spotmeter markers within the area and profile
Measurement presets	No measurements, Center spot, Hot spot, Cold spot, User preset 1, User preset 2
User presets	The user can select and combine measurements from any number of spots/boxes/circles/profiles/delta
Difference temperature	Delta temperature between the measurement functions and the reference temperature
Reference temperature	Manually set using the difference temperature
Atmospheric transmission correction	Automatic, based on the inputs for distance, atmospheric temperature, and relative humidity
Optics transmission correction	Automatic, based on signals from internal sensors
Emissivity correction	Variable from 0.01 to 1.0 or selected from the materials list
Reflected apparent temperature correction	Automatic, based on the input of the reflected temperature
External optics/windows correction	Automatic, based on the inputs of the window transmission and temperature

Measurement analysis	
Measurement corrections	Emissivity, reflected temperature, relative humidity, atmospheric temperature, object distance, external infrared window compensation
Colors (palettes)	Iron, Rainbow, Rainbow HC, White hot, Black hot, Arctic, Lava
Alarm	
Color alarm (isotherm)	<ul style="list-style-type: none"> • Above • Below • Interval • Condensation (moisture/humidity/dewpoint) • Insulation
Measurement function alarm	Audible/visual alarms (above/below) on any selected measurement function
Set-up	
Set-up commands	Define user presets, Save options, Programmable button, Reset options, Set up camera, Wi-Fi, GPS & compass, Bluetooth, Language, Time & units, Camera information
Languages	Arabic, Czech, Danish, Dutch, English, Finnish, French, German, Greek, Hungarian, Italian, Japanese, Korean, Norwegian, Polish, Portuguese, Russian, simplified Chinese, Swedish, traditional Chinese, Turkish
Service functions	
Camera software update	Use PC software FLIR Tools
Storage of images	
Image storage	Standard JPEG, including digital image and measurement data, on a memory card
Storage media	Removable media SD or SDHC card. Class 10 or better recommended
Image storage mode	<ul style="list-style-type: none"> • Simultaneous storage of thermal and digital images in the same JPEG file • Option to store a digital photo as a separate JPEG file
Time lapse	15 seconds to 24 hours
File formats	<ul style="list-style-type: none"> • Standard JPEG, measurement data included • CSQ, measurement data included
File formats, visual	Standard JPEG, automatically associated with the corresponding thermal image
Image annotations	
Voice	60 seconds (via Bluetooth) stored with the image
Text	Add table, select between predefined templates
Image description	Add short note (stored in the JPEG exif tag)
Sketch	<ul style="list-style-type: none"> • Draw on the thermal/digital image or add predefined stamps • Separate PC software with extensive report generation
METERLiNK	Wireless connection (Bluetooth) to: FLIR meters with METERLiNK

Geographic Information System	
GPS	Location data automatically added to every image from the built-in GPS
Compass	Camera direction automatically added to every image
Video recording in camera	
Radiometric IR-video recording	Real-time radiometric recording (RTRR) to the memory card
Non-radiometric IR-video recording	H.264 to the memory card
Visual video recording	H.264 to the memory card
Video streaming	
Radiometric IR-video streaming	Real-time radiometric streaming (RTRS) via USB
Non-radiometric IR-video streaming	<ul style="list-style-type: none"> • H.264 video using Wi-Fi • H.264 video using USB
Visual video streaming	<ul style="list-style-type: none"> • H.264 video using Wi-Fi • H.264 video using USB
Digital camera	
Built-in digital camera	5 Mpixel with LED light
Digital camera	Field of view adapts to the infrared lens
Video lamp	Built-in LED light
Laser pointer	
Laser	Activated by a dedicated button
Laser alignment	Position is automatically displayed on the infrared image
Laser classification	Class 2
Laser type	Semiconductor AlGaInP diode laser, 1 mW, 635 nm (red)
Data communication interfaces	
Interfaces	USB Micro-B, Bluetooth, Wi-Fi, HDMI
METERLiNK/Bluetooth	Communication with headset and external sensors
Wi-Fi	Infrastructure (network) or AP
SD Card	One card slot for removable SD memory cards
Audio	Microphone headset via Bluetooth for the voice annotation of images
USB	
USB	USB Micro-B: data transfer to and from a PC, uncompressed colorized video
USB, standard	<ul style="list-style-type: none"> • USB 2.0 High Speed • USB Micro-B connector
Video	
Video out	<ul style="list-style-type: none"> • HDMI 640 × 480 • HDMI 1280 × 720 • DVI 640 × 480 • DVI 800 × 600
Video, connector type	HDMI type C

Radio	
Wi-Fi	<ul style="list-style-type: none"> • Standard: 802.11 b/g/n • Frequency range: 2412–2462 MHz • Max. output power: 15 dBm
METERLiNK/Bluetooth	Frequency range: 2402–2480 MHz, supports 2.1 and 4.0
Antenna	Internal
Power system	
Battery type	Rechargeable Li ion battery
Battery operating time	>2.5 hours at 25°C (+68°F) and typical use
Charging system	In camera (AC adapter or 12 V from a vehicle) or two-bay charger
Charging time	2.5 hours to 90% capacity, charging status indicated by LEDs
Charging temperature	0°C to +45°C (+32°F to +113°F), except for the Korean market: +10°C to +45°C (+50°F to +113°F)
External power operation	AC adapter 90–260 V AC, 50/60 Hz or 12 V from a vehicle (cable with a standard plug, optional)
Power management	Automatic power-off functionality, user configurable between 5 minutes, 20 minutes, and no automatic shutdown
Environmental data	
Operating temperature range	–15°C to +50°C (+5°F to +122°F)
Storage temperature range	–40 to +70°C (–40 to +158°F)
Humidity (operating and storage)	IEC 60068-2-30 / 24 hours, 95% relative humidity, 25–40°C (77–104°F) / 2 cycles
EMC	<ul style="list-style-type: none"> • ETSI EN 301 489-1 (radio) • ETSI EN 301 489-17 • EN 61000-6-2 (Immunity) • EN 61000-6-3 (Emission) • FCC 47 CFR Part 15 Class B (Emission) • ICES-003
Radio spectrum	<ul style="list-style-type: none"> • ETSI EN 300 328 • FCC Part 15.247 • RSS-247 Issue 2
Encapsulation	IP 54 (IEC 60529)
Shock	25 g (IEC 60068-2-29)
Vibration	2 g (IEC 60068-2-6)
Safety	EN/UL/CSA/PSE 60950-1
Ergonomics	The viewfinder plus the 120° rotating optical block allow you to point the camera in multiple directions while maintaining a comfortable position
Physical data	
Weight	2.0 kg (4.3 lb.)
Camera size, excl. lens (L × W × H)	167.2 mm × 204.5 mm × 188.3 mm (6.6 in. × 8.0 in. × 7.4 in.)
Tripod mounting	UNC ¼"-20
Housing material	Magnesium

Warranty information	
Warranty	<ul style="list-style-type: none"> • 2 years parts and labor coverage on the camera • 5 years coverage on the battery • 10 years coverage on the detector – the most vital part of the whole camera
Shipping information	
List of contents	<ul style="list-style-type: none"> • Infrared camera with lens • Battery (2 ea.) • Battery charger • Bluetooth headset • Calibration certificate • FLIR Tools+ license card • Hard transport case • HDMI-HDMI cable • Lens cap • Memory card • Neck strap • Power supply, including multi-plugs • Printed documentation • USB cable, Std A to Micro-B
EAN-13	7332558010402
UPC-12	845188011055
Country of origin	Sweden

Supplies & accessories:

- T199064; IR lens f=36mm (28°) with case
- T199066; IR lens f=21.2mm (45°) with case
- T199077; IR lens f=83.4mm (12°) with case
- T910814; Power supply, incl. multi plugs
- T198126; Battery charger, incl. power supply with multi plugs T6xx
- T199364ACC; Battery Li-ion 3.65 V, 8.5 Ah, 32 Wh
- T911650ACC; Memory card SD Card 8 GB
- T198509; Cigarette lighter adapter kit, 12 VDC, 1.2 m/3.9 ft.
- T910930ACC; HDMI type C to DVI cable 1.5 m
- T910891ACC; HDMI type C to HDMI type A cable 1.5 m
- T198497; Large eyecup
- T197771ACC; Bluetooth Headset
- T911093; Tool belt
- T198533; USB cable Std A <-> Micro B
- T198586; FLIR Reporter Professional (license only)
- T198584; FLIR Tools
- T198583; FLIR Tools+ (download card incl. license key)
- DSW-10000; FLIR IR Camera Player
- APP-10002; FLIR Tools Mobile (Android Application)
- APP-10003; FLIR Tools Mobile (iPad/iPhone Application)
- APP-10004; FLIR Tools (MacOS Application)
- T199233; FLIR Atlas SDK for .NET
- T199234; FLIR Atlas SDK for MATLAB

30.19 FLIR T1050sc 12°

P/N: 72501-0401

Rev.: 46151

General description	
<p>The FLIR T1050sc is designed for the expert requiring the highest performance and the latest technology available. The camera combines excellent ergonomics and feature-rich flexibility with superior image quality at an infrared resolution of 1024 × 768 pixels. High accuracy and sensitivity together with radiometric recording and streaming options make the FLIR T1050sc well suited for advanced research and development.</p>	
<p>Benefits:</p> <ul style="list-style-type: none"> • Tailor made for research and development: The FLIR T1050sc has high accuracy and high sensitivity, to accurately measure the smallest temperature differences. With real-time radiometric recording, it is possible to capture fast events on the camera's SD card for further analysis by the supplied analysis software. • Flexible and feature rich: A wide variety of measuring and analysis functions make the FLIR T1050sc flexible for your every need. Two programmable buttons provide easy access to favorite functions. • Highest performance with the latest technology: The FLIR T1050sc is equipped with the innovative Multi Spectral Dynamic Imaging (MSX) feature, which produces an image richer in detail than ever before. With its continuous autofocus, the FLIR T1050sc is a fully automatic infrared camera. • Support for UltraMax: When enabling UltraMax in the camera, the resolution of images can be substantially enhanced when importing the images into FLIR Tools. 	
Imaging and optical data	
IR resolution	1024 × 768 pixels
MSX resolution	1024 × 768 pixels
UltraMax	Yes
Thermal sensitivity/NETD	<20 mK @ +30°C (+86°F)
Field of view (FOV)	12° × 9°
Minimum IR focus distance	1.3 m (4.26 ft.)
Minimum IR–visual alignment distance	1.3 m (4.26 ft.)
Focal length	83.4 mm (3.28 in.)
Spatial resolution (IFOV)	0.20 mrad
Lens identification	Automatic
F-number	1.2
Image frequency	30 Hz
Focus	One shot or manual
Digital zoom	1–8× continuous
Digital image enhancement	Adaptive digital noise reduction
Detector data	
Detector type	Focal plane array (FPA), uncooled microbolometer
Spectral range	7.5–14 μm
Detector pitch	17 μm
Time constant	< 10 ms
Image presentation	
Display	Built-in touch screen, 4.3 in. wide screen LCD, 800 × 480 pixels
Display type	Capacitive touch screen
Auto orientation	Automatic landscape or portrait

Image presentation	
Viewfinder	Built-in 800 × 480 pixels
Automatic image adjustment	Continuous, histogram based
Automatic image adjustment, type	Standard or histogram based on the image content
Manual image adjustment	Linear based, possible to adjust level/span/max./min.

Image presentation modes	
Image modes	Thermal, thermal MSX, picture in picture, digital camera
Infrared image	Full color infrared image
Visual image	Full color visual image
Multi Spectral Dynamic Imaging (MSX)	Thermal image with enhanced detail presentation
Picture in Picture	Resizable and movable infrared area on the visual image
Gallery	<ul style="list-style-type: none"> Review thumbnail/full image on the camera Edit measurements/palettes/image modes on the camera

Measurement		
Object temperature range		Accuracy
-40 to +150°C (-40 to +302°F)	-40 to +5°C (-40 to +41°F)	±2°C (±3.6°F)
	+5 to +100°C (+41 to +212°F)	±1°C (±1.8°F)
	+100 to +150°C (+212 to +302°F)	±1%
0 to +650°C (+32 to +1202°F)	0 to +100°C (+32 to +212°F)	±2°C (±3.6°F)
	+100 to +650°C (+212 to +1202°F)	±2%
+300 to +2000°C (+572 to +3632°F)	+300 to +2000°C (+572 to +3632°F)	±2%

**NOTE**

For HSI use, above 30 Hz frame rate, the typical accuracy will be ±2.5°C (±4.5°F), or 2.5% of reading @ 25°C (77°F).

Measurement analysis	
Spotmeter	10
Area	5 + 5 areas (boxes and circles) with max./min./average
Profile	1 line profile with max./min. temperature
Automatic hot/cold detection	Auto hot or cold spotmeter markers within the area and profile
Measurement presets	No measurements, Center spot, Hot spot, Cold spot, User preset 1, User preset 2
User presets	The user can select and combine measurements from any number of spots/boxes/circles/profiles/delta
Difference temperature	Delta temperature between the measurement functions and the reference temperature
Reference temperature	Manually set using the difference temperature

Measurement analysis	
Atmospheric transmission correction	Automatic, based on the inputs for distance, atmospheric temperature, and relative humidity
Optics transmission correction	Automatic, based on signals from internal sensors
Emissivity correction	Variable from 0.01 to 1.0 or selected from the materials list
Reflected apparent temperature correction	Automatic, based on the input of the reflected temperature
External optics/windows correction	Automatic, based on the inputs of the window transmission and temperature
Measurement corrections	Emissivity, reflected temperature, relative humidity, atmospheric temperature, object distance, external infrared window compensation
Colors (palettes)	Iron, Rainbow, Rainbow HC, White hot, Black hot, Arctic, Lava
Alarm	
Color alarm (isotherm)	<ul style="list-style-type: none"> • Above • Below • Interval • Condensation (moisture/humidity/dewpoint) • Insulation
Measurement function alarm	Audible/visual alarms (above/below) on any selected measurement function
Set-up	
Set-up commands	Define user presets, Save options, Programmable button, Reset options, Set up camera, Wi-Fi, GPS & compass, Bluetooth, Language, Time & units, Camera information
Languages	Arabic, Czech, Danish, Dutch, English, Finnish, French, German, Greek, Hungarian, Italian, Japanese, Korean, Norwegian, Polish, Portuguese, Russian, simplified Chinese, Swedish, traditional Chinese, Turkish
Service functions	
Camera software update	Use PC software FLIR Tools
Storage of images	
Image storage	Standard JPEG, including digital image and measurement data, on a memory card
Storage media	Removable media SD or SDHC card. Class 10 or better recommended
Image storage mode	<ul style="list-style-type: none"> • Simultaneous storage of thermal and digital images in the same JPEG file • Option to store a digital photo as a separate JPEG file
Time lapse	15 seconds to 24 hours
File formats	<ul style="list-style-type: none"> • Standard JPEG, measurement data included • CSQ, measurement data included
File formats, visual	Standard JPEG, automatically associated with the corresponding thermal image
Image annotations	
Voice	60 seconds (via Bluetooth) stored with the image
Text	Add table, select between predefined templates

Image annotations	
Image description	Add short note (stored in the JPEG exif tag)
Sketch	<ul style="list-style-type: none"> • Draw on the thermal/digital image or add pre-defined stamps • Separate PC software with extensive report generation
METERLiNK	Wireless connection (Bluetooth) to: FLIR meters with METERLiNK
Geographic Information System	
GPS	Location data automatically added to every image from the built-in GPS
Compass	Camera direction automatically added to every image
Video recording in camera	
Radiometric IR-video recording	Real-time radiometric recording (RTRR) to the memory card
Non-radiometric IR-video recording	H.264 to the memory card
Visual video recording	H.264 to the memory card
Video streaming	
Radiometric IR-video streaming	<ul style="list-style-type: none"> • Full dynamic un-compressed 120 Hz 16-bit full frame (2 Gbit) to a PC using an HSI box • Real-time radiometric streaming 30 Hz (RTRS) via USB
Non-radiometric IR-video streaming	<ul style="list-style-type: none"> • H.264 video using Wi-Fi • H.264 video using USB
Visual video streaming	<ul style="list-style-type: none"> • H.264 video using Wi-Fi • H.264 video using USB
Windowing	<ul style="list-style-type: none"> • 30 Hz: 1024 × 768 (full image height) • Based on 30 Hz: 120 Hz windowing 1024 × 192 (¼ of full image height), for range -40 to +150°C (-40 to +302°F) • 120 Hz: 1024 × 768 (full image height) • Based on 120 Hz: 240 Hz windowing 1024 × 384 (½ of full image height), for range 0 to +650°C (+32 to +1202°F) and range +300 to +2000°C (+572 to +3632°F)
Digital camera	
Built-in digital camera	5 Mpixel with LED light
Digital camera	Field of view adapts to the infrared lens
Video lamp	Built-in LED light
Laser pointer	
Laser	Activated by a dedicated button
Laser alignment	Position is automatically displayed on the infrared image
Laser classification	Class 2
Laser type	Semiconductor AlGaInP diode laser, 1 mW, 635 nm (red)

Data communication interfaces	
Interfaces	USB Micro-B, Bluetooth, Wi-Fi, HDMI, USB3 Vision via HSI box
METERLiNK/Bluetooth	Communication with headset and external sensors
Wi-Fi	Infrastructure (network) or AP
SD Card	One card slot for removable SD memory cards
Audio	Microphone headset via Bluetooth for the voice annotation of images
USB	
USB	USB Micro-B: data transfer to and from a PC, uncompressed colorized video
USB, standard	<ul style="list-style-type: none"> • USB 2.0 High Speed • USB Micro-B connector • USB3 Vision via HSI box
Video	
Video out	<ul style="list-style-type: none"> • HDMI 640 × 480 • HDMI 1280 × 720 • DVI 640 × 480 • DVI 800 × 600
Video, connector type	HDMI type C
Radio	
Wi-Fi	<ul style="list-style-type: none"> • Standard: 802.11 b/g/n • Frequency range: 2412–2462 MHz • Max. output power: 15 dBm
METERLiNK/Bluetooth	Frequency range: 2402–2480 MHz, supports 2.1 and 4.0
Antenna	Internal
Power system	
Battery type	Rechargeable Li ion battery
Battery operating time	>2.5 hours at 25°C (+68°F) and typical use
Charging system	In camera (AC adapter or 12 V from a vehicle) or two-bay charger
Charging time	2.5 hours to 90% capacity, charging status indicated by LEDs
Charging temperature	0°C to +45°C (+32°F to +113°F), except for the Korean market: +10°C to +45°C (+50°F to +113°F)
External power operation	AC adapter 90–260 V AC, 50/60 Hz or 12 V from a vehicle (cable with a standard plug, optional)
Power management	Automatic power-off functionality, user configurable between 5 minutes, 20 minutes, and no automatic shutdown
Environmental data	
Operating temperature range	–15°C to +50°C (+5°F to +122°F)
Storage temperature range	–40 to +70°C (–40 to +158°F)
Humidity (operating and storage)	IEC 60068-2-30 / 24 hours, 95% relative humidity, 25–40°C (77–104°F) / 2 cycles

Environmental data	
EMC	<ul style="list-style-type: none"> • ETSI EN 301 489-1 (radio) • ETSI EN 301 489-17 • EN 61000-6-2 (Immunity) • EN 61000-6-3 (Emission) • FCC 47 CFR Part 15 Class B (Emission) • ICES-003
Radio spectrum	<ul style="list-style-type: none"> • ETSI EN 300 328 • FCC Part 15.247 • RSS-247 Issue 2
Encapsulation	IP 54 (IEC 60529)
Shock	25 g (IEC 60068-2-29)
Vibration	2 g (IEC 60068-2-6)
Safety	EN/UL/CSA/PSE 60950-1
Ergonomics	The viewfinder plus the 120° rotating optical block allow you to point the camera in multiple directions while maintaining a comfortable position
Physical data	
Weight	2.1 kg (4.6 lb.)
Camera size, excl. lens (L x W x H)	167.2 mm x 204.5 mm x 188.3 mm (6.6 in. x 8.0 in. x 7.4 in.)
Tripod mounting	UNC ¼"-20
Housing material	Magnesium
Warranty information	
Warranty	<ul style="list-style-type: none"> • 2 years parts and labor coverage on the camera • 5 years coverage on the battery • 10 years coverage on the detector – the most vital part of the whole camera
Shipping information	
List of contents	<ul style="list-style-type: none"> • Infrared camera with lens • Battery (2 ea.) • Battery charger • Bluetooth headset • Calibration certificate • FLIR Tools+ license card • FLIR T10xx SC kit (in separate hard transport case): <ul style="list-style-type: none"> ◦ High-speed interface ◦ USB cable (USB 3), 3 m (10 ft.) ◦ Digital I/O connector ◦ FLIR ResearchIR Max license card ◦ Printed documentation • Hard transport case • HDMI-HDMI cable • Lens cap • Memory card • Neck strap • Power supply, including multi-plugs • Printed documentation • USB cable, Std A to Micro-B
EAN-13	7332558010419
UPC-12	845188011062
Country of origin	Sweden

Supplies & accessories:

- T199064; IR lens f=36mm (28°) with case
- T199066; IR lens f=21.2mm (45°) with case
- T199077; IR lens f=83.4mm (12°) with case
- T910814; Power supply, incl. multi plugs
- T198126; Battery charger, incl. power supply with multi plugs T6xx
- T199364ACC; Battery Li-ion 3.65 V, 8.5 Ah, 32 Wh
- T911650ACC; Memory card SD Card 8 GB
- T198509; Cigarette lighter adapter kit, 12 VDC, 1.2 m/3.9 ft.
- T910930ACC; HDMI type C to DVI cable 1.5 m
- T910891ACC; HDMI type C to HDMI type A cable 1.5 m
- 72500-0002; FLIR T10xx SC kit
- T198497; Large eyecup
- T197771ACC; Bluetooth Headset
- T911093; Tool belt
- T198533; USB cable Std A <-> Micro B
- T198586; FLIR Reporter Professional (license only)
- T198584; FLIR Tools
- T198583; FLIR Tools+ (download card incl. license key)
- DSW-10000; FLIR IR Camera Player
- APP-10002; FLIR Tools Mobile (Android Application)
- APP-10003; FLIR Tools Mobile (iPad/iPhone Application)
- APP-10004; FLIR Tools (MacOS Application)
- T198697; FLIR ResearchIR Max + HSDR 4 (hardware sec. dev.)
- T199014; FLIR ResearchIR Max + HSDR 4 (printed license key)
- T199044; FLIR ResearchIR Max + HSDR 4 Upgrade (printed license key)
- T198696; FLIR ResearchIR Max 4 (hardware sec. dev.)
- T199013; FLIR ResearchIR Max 4 (printed license key)
- T199043; FLIR ResearchIR Max 4 Upgrade (printed license key)
- T198731; FLIR ResearchIR Standard 4 (hardware sec. dev.)
- T199012; FLIR ResearchIR Standard 4 (printed license key)
- T199042; FLIR ResearchIR Standard 4 Upgrade (printed license key)
- T199233; FLIR Atlas SDK for .NET
- T199234; FLIR Atlas SDK for MATLAB

30.20 FLIR T1050sc 28°

P/N: 72501-0402

Rev.: 46152

General description	
<p>The FLIR T1050sc is designed for the expert requiring the highest performance and the latest technology available. The camera combines excellent ergonomics and feature-rich flexibility with superior image quality at an infrared resolution of 1024 × 768 pixels. High accuracy and sensitivity together with radiometric recording and streaming options make the FLIR T1050sc well suited for advanced research and development.</p>	
<p>Benefits:</p> <ul style="list-style-type: none"> • Tailor made for research and development: The FLIR T1050sc has high accuracy and high sensitivity, to accurately measure the smallest temperature differences. With real-time radiometric recording, it is possible to capture fast events on the camera's SD card for further analysis by the supplied analysis software. • Flexible and feature rich: A wide variety of measuring and analysis functions make the FLIR T1050sc flexible for your every need. Two programmable buttons provide easy access to favorite functions. • Highest performance with the latest technology: The FLIR T1050sc is equipped with the innovative Multi Spectral Dynamic Imaging (MSX) feature, which produces an image richer in detail than ever before. With its continuous autofocus, the FLIR T1050sc is a fully automatic infrared camera. • Support for UltraMax: When enabling UltraMax in the camera, the resolution of images can be substantially enhanced when importing the images into FLIR Tools. 	
Imaging and optical data	
IR resolution	1024 × 768 pixels
MSX resolution	1024 × 768 pixels
UltraMax	Yes
Thermal sensitivity/NETD	<20 mK @ +30°C (+86°F)
Field of view (FOV)	28° × 21°
Minimum IR focus distance	0.4 m (1.32 ft.)
Minimum IR–visual alignment distance	0.4 m (1.32 ft.)
Focal length	36 mm (1.42 in.)
Spatial resolution (IFOV)	0.47 mrad
Lens identification	Automatic
F-number	1.15
Image frequency	30 Hz
Focus	One shot or manual
Digital zoom	1–8× continuous
Digital image enhancement	Adaptive digital noise reduction
Detector data	
Detector type	Focal plane array (FPA), uncooled microbolometer
Spectral range	7.5–14 μm
Detector pitch	17 μm
Time constant	< 10 ms
Image presentation	
Display	Built-in touch screen, 4.3 in. wide screen LCD, 800 × 480 pixels
Display type	Capacitive touch screen
Auto orientation	Automatic landscape or portrait

Image presentation	
Viewfinder	Built-in 800 × 480 pixels
Automatic image adjustment	Continuous, histogram based
Automatic image adjustment, type	Standard or histogram based on the image content
Manual image adjustment	Linear based, possible to adjust level/span/max./min.

Image presentation modes	
Image modes	Thermal, thermal MSX, picture in picture, digital camera
Infrared image	Full color infrared image
Visual image	Full color visual image
Multi Spectral Dynamic Imaging (MSX)	Thermal image with enhanced detail presentation
Picture in Picture	Resizable and movable infrared area on the visual image
Gallery	<ul style="list-style-type: none"> Review thumbnail/full image on the camera Edit measurements/palettes/image modes on the camera

Measurement		
Object temperature range		Accuracy
-40 to +150°C (-40 to +302°F)	-40 to +5°C (-40 to +41°F)	±2°C (±3.6°F)
	+5 to +100°C (+41 to +212°F)	±1°C (±1.8°F)
	+100 to +150°C (+212 to +302°F)	±1%
0 to +650°C (+32 to +1202°F)	0 to +100°C (+32 to +212°F)	±2°C (±3.6°F)
	+100 to +650°C (+212 to +1202°F)	±2%
+300 to +2000°C (+572 to +3632°F)	+300 to +2000°C (+572 to +3632°F)	±2%

**NOTE**

For HSI use, above 30 Hz frame rate, the typical accuracy will be ±2.5°C (±4.5°F), or 2.5% of reading @ 25°C (77°F).

Measurement analysis	
Spotmeter	10
Area	5 + 5 areas (boxes and circles) with max./min./average
Profile	1 line profile with max./min. temperature
Automatic hot/cold detection	Auto hot or cold spotmeter markers within the area and profile
Measurement presets	No measurements, Center spot, Hot spot, Cold spot, User preset 1, User preset 2
User presets	The user can select and combine measurements from any number of spots/boxes/circles/profiles/delta
Difference temperature	Delta temperature between the measurement functions and the reference temperature
Reference temperature	Manually set using the difference temperature

Measurement analysis	
Atmospheric transmission correction	Automatic, based on the inputs for distance, atmospheric temperature, and relative humidity
Optics transmission correction	Automatic, based on signals from internal sensors
Emissivity correction	Variable from 0.01 to 1.0 or selected from the materials list
Reflected apparent temperature correction	Automatic, based on the input of the reflected temperature
External optics/windows correction	Automatic, based on the inputs of the window transmission and temperature
Measurement corrections	Emissivity, reflected temperature, relative humidity, atmospheric temperature, object distance, external infrared window compensation
Colors (palettes)	Iron, Rainbow, Rainbow HC, White hot, Black hot, Arctic, Lava
Alarm	
Color alarm (isotherm)	<ul style="list-style-type: none"> • Above • Below • Interval • Condensation (moisture/humidity/dewpoint) • Insulation
Measurement function alarm	Audible/visual alarms (above/below) on any selected measurement function
Set-up	
Set-up commands	Define user presets, Save options, Programmable button, Reset options, Set up camera, Wi-Fi, GPS & compass, Bluetooth, Language, Time & units, Camera information
Languages	Arabic, Czech, Danish, Dutch, English, Finnish, French, German, Greek, Hungarian, Italian, Japanese, Korean, Norwegian, Polish, Portuguese, Russian, simplified Chinese, Swedish, traditional Chinese, Turkish
Service functions	
Camera software update	Use PC software FLIR Tools
Storage of images	
Image storage	Standard JPEG, including digital image and measurement data, on a memory card
Storage media	Removable media SD or SDHC card. Class 10 or better recommended
Image storage mode	<ul style="list-style-type: none"> • Simultaneous storage of thermal and digital images in the same JPEG file • Option to store a digital photo as a separate JPEG file
Time lapse	15 seconds to 24 hours
File formats	<ul style="list-style-type: none"> • Standard JPEG, measurement data included • CSQ, measurement data included
File formats, visual	Standard JPEG, automatically associated with the corresponding thermal image
Image annotations	
Voice	60 seconds (via Bluetooth) stored with the image
Text	Add table, select between predefined templates

Image annotations	
Image description	Add short note (stored in the JPEG exif tag)
Sketch	<ul style="list-style-type: none"> • Draw on the thermal/digital image or add pre-defined stamps • Separate PC software with extensive report generation
METERLiNK	Wireless connection (Bluetooth) to: FLIR meters with METERLiNK
Geographic Information System	
GPS	Location data automatically added to every image from the built-in GPS
Compass	Camera direction automatically added to every image
Video recording in camera	
Radiometric IR-video recording	Real-time radiometric recording (RTRR) to the memory card
Non-radiometric IR-video recording	H.264 to the memory card
Visual video recording	H.264 to the memory card
Video streaming	
Radiometric IR-video streaming	<ul style="list-style-type: none"> • Full dynamic un-compressed 120 Hz 16-bit full frame (2 Gbit) to a PC using an HSI box • Real-time radiometric streaming 30 Hz (RTRS) via USB
Non-radiometric IR-video streaming	<ul style="list-style-type: none"> • H.264 video using Wi-Fi • H.264 video using USB
Visual video streaming	<ul style="list-style-type: none"> • H.264 video using Wi-Fi • H.264 video using USB
Windowing	<ul style="list-style-type: none"> • 30 Hz: 1024 × 768 (full image height) • Based on 30 Hz: 120 Hz windowing 1024 × 192 (¼ of full image height), for range -40 to +150°C (-40 to +302°F) • 120 Hz: 1024 × 768 (full image height) • Based on 120 Hz: 240 Hz windowing 1024 × 384 (½ of full image height), for range 0 to +650°C (+32 to +1202°F) and range +300 to +2000°C (+572 to +3632°F)
Digital camera	
Built-in digital camera	5 Mpixel with LED light
Digital camera	Field of view adapts to the infrared lens
Video lamp	Built-in LED light
Laser pointer	
Laser	Activated by a dedicated button
Laser alignment	Position is automatically displayed on the infrared image
Laser classification	Class 2
Laser type	Semiconductor AlGaInP diode laser, 1 mW, 635 nm (red)

Data communication interfaces	
Interfaces	USB Micro-B, Bluetooth, Wi-Fi, HDMI, USB3 Vision via HSI box
METERLiNK/Bluetooth	Communication with headset and external sensors
Wi-Fi	Infrastructure (network) or AP
SD Card	One card slot for removable SD memory cards
Audio	Microphone headset via Bluetooth for the voice annotation of images
USB	
USB	USB Micro-B: data transfer to and from a PC, uncompressed colorized video
USB, standard	<ul style="list-style-type: none"> • USB 2.0 High Speed • USB Micro-B connector • USB3 Vision via HSI box
Video	
Video out	<ul style="list-style-type: none"> • HDMI 640 × 480 • HDMI 1280 × 720 • DVI 640 × 480 • DVI 800 × 600
Video, connector type	HDMI type C
Radio	
Wi-Fi	<ul style="list-style-type: none"> • Standard: 802.11 b/g/n • Frequency range: 2412–2462 MHz • Max. output power: 15 dBm
METERLiNK/Bluetooth	Frequency range: 2402–2480 MHz, supports 2.1 and 4.0
Antenna	Internal
Power system	
Battery type	Rechargeable Li ion battery
Battery operating time	>2.5 hours at 25°C (+68°F) and typical use
Charging system	In camera (AC adapter or 12 V from a vehicle) or two-bay charger
Charging time	2.5 hours to 90% capacity, charging status indicated by LEDs
Charging temperature	0°C to +45°C (+32°F to +113°F), except for the Korean market: +10°C to +45°C (+50°F to +113°F)
External power operation	AC adapter 90–260 V AC, 50/60 Hz or 12 V from a vehicle (cable with a standard plug, optional)
Power management	Automatic power-off functionality, user configurable between 5 minutes, 20 minutes, and no automatic shutdown
Environmental data	
Operating temperature range	–15°C to +50°C (+5°F to +122°F)
Storage temperature range	–40 to +70°C (–40 to +158°F)
Humidity (operating and storage)	IEC 60068-2-30 / 24 hours, 95% relative humidity, 25–40°C (77–104°F) / 2 cycles

Environmental data	
EMC	<ul style="list-style-type: none"> • ETSI EN 301 489-1 (radio) • ETSI EN 301 489-17 • EN 61000-6-2 (Immunity) • EN 61000-6-3 (Emission) • FCC 47 CFR Part 15 Class B (Emission) • ICES-003
Radio spectrum	<ul style="list-style-type: none"> • ETSI EN 300 328 • FCC Part 15.247 • RSS-247 Issue 2
Encapsulation	IP 54 (IEC 60529)
Shock	25 g (IEC 60068-2-29)
Vibration	2 g (IEC 60068-2-6)
Safety	EN/UL/CSA/PSE 60950-1
Ergonomics	The viewfinder plus the 120° rotating optical block allow you to point the camera in multiple directions while maintaining a comfortable position
Physical data	
Weight	1.9 kg (4.3 lb.)
Camera size, excl. lens (L x W x H)	167.2 mm x 204.5 mm x 188.3 mm (6.6 in. x 8.0 in. x 7.4 in.)
Tripod mounting	UNC ¼"-20
Housing material	Magnesium
Warranty information	
Warranty	<ul style="list-style-type: none"> • 2 years parts and labor coverage on the camera • 5 years coverage on the battery • 10 years coverage on the detector – the most vital part of the whole camera
Shipping information	
List of contents	<ul style="list-style-type: none"> • Infrared camera with lens • Battery (2 ea.) • Battery charger • Bluetooth headset • Calibration certificate • FLIR Tools+ license card • FLIR T10xx SC kit (in separate hard transport case): <ul style="list-style-type: none"> ◦ High-speed interface ◦ USB cable (USB 3), 3 m (10 ft.) ◦ Digital I/O connector ◦ FLIR ResearchIR Max license card ◦ Printed documentation • Hard transport case • HDMI-HDMI cable • Lens cap • Memory card • Neck strap • Power supply, including multi-plugs • Printed documentation • USB cable, Std A to Micro-B
EAN-13	7332558010426
UPC-12	845188011079
Country of origin	Sweden

Supplies & accessories:

- T199064; IR lens f=36mm (28°) with case
- T199065; Close-up lens 3x (51 micron) with case
- T199066; IR lens f=21.2mm (45°) with case
- T199077; IR lens f=83.4mm (12°) with case
- T910814; Power supply, incl. multi plugs
- T198126; Battery charger, incl. power supply with multi plugs T6xx
- T199364ACC; Battery Li-ion 3.65 V, 8.5 Ah, 32 Wh
- T911650ACC; Memory card SD Card 8 GB
- T198509; Cigarette lighter adapter kit, 12 VDC, 1.2 m/3.9 ft.
- T910930ACC; HDMI type C to DVI cable 1.5 m
- T910891ACC; HDMI type C to HDMI type A cable 1.5 m
- 72500-0002; FLIR T10xx SC kit
- T198497; Large eyecup
- T197771ACC; Bluetooth Headset
- T911093; Tool belt
- T198533; USB cable Std A <-> Micro B
- T198586; FLIR Reporter Professional (license only)
- T198584; FLIR Tools
- T198583; FLIR Tools+ (download card incl. license key)
- DSW-10000; FLIR IR Camera Player
- APP-10002; FLIR Tools Mobile (Android Application)
- APP-10003; FLIR Tools Mobile (iPad/iPhone Application)
- APP-10004; FLIR Tools (MacOS Application)
- T198697; FLIR ResearchIR Max + HSDR 4 (hardware sec. dev.)
- T199014; FLIR ResearchIR Max + HSDR 4 (printed license key)
- T199044; FLIR ResearchIR Max + HSDR 4 Upgrade (printed license key)
- T198696; FLIR ResearchIR Max 4 (hardware sec. dev.)
- T199013; FLIR ResearchIR Max 4 (printed license key)
- T199043; FLIR ResearchIR Max 4 Upgrade (printed license key)
- T198731; FLIR ResearchIR Standard 4 (hardware sec. dev.)
- T199012; FLIR ResearchIR Standard 4 (printed license key)
- T199042; FLIR ResearchIR Standard 4 Upgrade (printed license key)
- T199233; FLIR Atlas SDK for .NET
- T199234; FLIR Atlas SDK for MATLAB

30.21 FLIR T1050sc 45°

P/N: 72501-0403

Rev.: 46153

General description	
<p>The FLIR T1050sc is designed for the expert requiring the highest performance and the latest technology available. The camera combines excellent ergonomics and feature-rich flexibility with superior image quality at an infrared resolution of 1024 × 768 pixels. High accuracy and sensitivity together with radiometric recording and streaming options make the FLIR T1050sc well suited for advanced research and development.</p>	
<p>Benefits:</p> <ul style="list-style-type: none"> • Tailor made for research and development: The FLIR T1050sc has high accuracy and high sensitivity, to accurately measure the smallest temperature differences. With real-time radiometric recording, it is possible to capture fast events on the camera's SD card for further analysis by the supplied analysis software. • Flexible and feature rich: A wide variety of measuring and analysis functions make the FLIR T1050sc flexible for your every need. Two programmable buttons provide easy access to favorite functions. • Highest performance with the latest technology: The FLIR T1050sc is equipped with the innovative Multi Spectral Dynamic Imaging (MSX) feature, which produces an image richer in detail than ever before. With its continuous autofocus, the FLIR T1050sc is a fully automatic infrared camera. • Support for UltraMax: When enabling UltraMax in the camera, the resolution of images can be substantially enhanced when importing the images into FLIR Tools. 	
Imaging and optical data	
IR resolution	1024 × 768 pixels
MSX resolution	1024 × 768 pixels
UltraMax	Yes
Thermal sensitivity/NETD	<20 mK @ +30°C (+86°F)
Field of view (FOV)	45° × 34°
Minimum IR focus distance	0.2 m (0.66 ft.)
Minimum IR–visual alignment distance	0.5 m (1.64 ft.)
Focal length	21.2 mm (0.83 in.)
Spatial resolution (IFOV)	0.80 mrad
Lens identification	Automatic
F-number	1.1
Image frequency	30 Hz
Focus	One shot or manual
Digital zoom	1–8× continuous
Digital image enhancement	Adaptive digital noise reduction
Detector data	
Detector type	Focal plane array (FPA), uncooled microbolometer
Spectral range	7.5–14 μm
Detector pitch	17 μm
Time constant	< 10 ms
Image presentation	
Display	Built-in touch screen, 4.3 in. wide screen LCD, 800 × 480 pixels
Display type	Capacitive touch screen
Auto orientation	Automatic landscape or portrait

Image presentation	
Viewfinder	Built-in 800 × 480 pixels
Automatic image adjustment	Continuous, histogram based
Automatic image adjustment, type	Standard or histogram based on the image content
Manual image adjustment	Linear based, possible to adjust level/span/max./min.

Image presentation modes	
Image modes	Thermal, thermal MSX, picture in picture, digital camera
Infrared image	Full color infrared image
Visual image	Full color visual image
Multi Spectral Dynamic Imaging (MSX)	Thermal image with enhanced detail presentation
Picture in Picture	Resizable and movable infrared area on the visual image
Gallery	<ul style="list-style-type: none"> Review thumbnail/full image on the camera Edit measurements/palettes/image modes on the camera

Measurement		
Object temperature range		Accuracy
-40 to +150°C (-40 to +302°F)	-40 to +5°C (-40 to +41°F)	±2°C (±3.6°F)
	+5 to +100°C (+41 to +212°F)	±1°C (±1.8°F)
	+100 to +150°C (+212 to +302°F)	±1%
0 to +650°C (+32 to +1202°F)	0 to +100°C (+32 to +212°F)	±2°C (±3.6°F)
	+100 to +650°C (+212 to +1202°F)	±2%
+300 to +2000°C (+572 to +3632°F)	+300 to +2000°C (+572 to +3632°F)	±2%

**NOTE**

For HSI use, above 30 Hz frame rate, the typical accuracy will be ±2.5°C (±4.5°F), or 2.5% of reading @ 25°C (77°F).

Measurement analysis	
Spotmeter	10
Area	5 + 5 areas (boxes and circles) with max./min./average
Profile	1 line profile with max./min. temperature
Automatic hot/cold detection	Auto hot or cold spotmeter markers within the area and profile
Measurement presets	No measurements, Center spot, Hot spot, Cold spot, User preset 1, User preset 2
User presets	The user can select and combine measurements from any number of spots/boxes/circles/profiles/delta
Difference temperature	Delta temperature between the measurement functions and the reference temperature
Reference temperature	Manually set using the difference temperature

Measurement analysis	
Atmospheric transmission correction	Automatic, based on the inputs for distance, atmospheric temperature, and relative humidity
Optics transmission correction	Automatic, based on signals from internal sensors
Emissivity correction	Variable from 0.01 to 1.0 or selected from the materials list
Reflected apparent temperature correction	Automatic, based on the input of the reflected temperature
External optics/windows correction	Automatic, based on the inputs of the window transmission and temperature
Measurement corrections	Emissivity, reflected temperature, relative humidity, atmospheric temperature, object distance, external infrared window compensation
Colors (palettes)	Iron, Rainbow, Rainbow HC, White hot, Black hot, Arctic, Lava
Alarm	
Color alarm (isotherm)	<ul style="list-style-type: none"> • Above • Below • Interval • Condensation (moisture/humidity/dewpoint) • Insulation
Measurement function alarm	Audible/visual alarms (above/below) on any selected measurement function
Set-up	
Set-up commands	Define user presets, Save options, Programmable button, Reset options, Set up camera, Wi-Fi, GPS & compass, Bluetooth, Language, Time & units, Camera information
Languages	Arabic, Czech, Danish, Dutch, English, Finnish, French, German, Greek, Hungarian, Italian, Japanese, Korean, Norwegian, Polish, Portuguese, Russian, simplified Chinese, Swedish, traditional Chinese, Turkish
Service functions	
Camera software update	Use PC software FLIR Tools
Storage of images	
Image storage	Standard JPEG, including digital image and measurement data, on a memory card
Storage media	Removable media SD or SDHC card. Class 10 or better recommended
Image storage mode	<ul style="list-style-type: none"> • Simultaneous storage of thermal and digital images in the same JPEG file • Option to store a digital photo as a separate JPEG file
Time lapse	15 seconds to 24 hours
File formats	<ul style="list-style-type: none"> • Standard JPEG, measurement data included • CSQ, measurement data included
File formats, visual	Standard JPEG, automatically associated with the corresponding thermal image
Image annotations	
Voice	60 seconds (via Bluetooth) stored with the image
Text	Add table, select between predefined templates

Image annotations	
Image description	Add short note (stored in the JPEG exif tag)
Sketch	<ul style="list-style-type: none"> • Draw on the thermal/digital image or add pre-defined stamps • Separate PC software with extensive report generation
METERLiNK	Wireless connection (Bluetooth) to: FLIR meters with METERLiNK
Geographic Information System	
GPS	Location data automatically added to every image from the built-in GPS
Compass	Camera direction automatically added to every image
Video recording in camera	
Radiometric IR-video recording	Real-time radiometric recording (RTRR) to the memory card
Non-radiometric IR-video recording	H.264 to the memory card
Visual video recording	H.264 to the memory card
Video streaming	
Radiometric IR-video streaming	<ul style="list-style-type: none"> • Full dynamic un-compressed 120 Hz 16-bit full frame (2 Gbit) to a PC using an HSI box • Real-time radiometric streaming 30 Hz (RTRS) via USB
Non-radiometric IR-video streaming	<ul style="list-style-type: none"> • H.264 video using Wi-Fi • H.264 video using USB
Visual video streaming	<ul style="list-style-type: none"> • H.264 video using Wi-Fi • H.264 video using USB
Windowing	<ul style="list-style-type: none"> • 30 Hz: 1024 × 768 (full image height) • Based on 30 Hz: 120 Hz windowing 1024 × 192 (¼ of full image height), for range -40 to +150°C (-40 to +302°F) • 120 Hz: 1024 × 768 (full image height) • Based on 120 Hz: 240 Hz windowing 1024 × 384 (½ of full image height), for range 0 to +650°C (+32 to +1202°F) and range +300 to +2000°C (+572 to +3632°F)
Digital camera	
Built-in digital camera	5 Mpixel with LED light
Digital camera	Field of view adapts to the infrared lens
Video lamp	Built-in LED light
Laser pointer	
Laser	Activated by a dedicated button
Laser alignment	Position is automatically displayed on the infrared image
Laser classification	Class 2
Laser type	Semiconductor AlGaInP diode laser, 1 mW, 635 nm (red)

Data communication interfaces	
Interfaces	USB Micro-B, Bluetooth, Wi-Fi, HDMI, USB3 Vision via HSI box
METERLiNK/Bluetooth	Communication with headset and external sensors
Wi-Fi	Infrastructure (network) or AP
SD Card	One card slot for removable SD memory cards
Audio	Microphone headset via Bluetooth for the voice annotation of images
USB	
USB	USB Micro-B: data transfer to and from a PC, uncompressed colorized video
USB, standard	<ul style="list-style-type: none"> • USB 2.0 High Speed • USB Micro-B connector • USB3 Vision via HSI box
Video	
Video out	<ul style="list-style-type: none"> • HDMI 640 × 480 • HDMI 1280 × 720 • DVI 640 × 480 • DVI 800 × 600
Video, connector type	HDMI type C
Radio	
Wi-Fi	<ul style="list-style-type: none"> • Standard: 802.11 b/g/n • Frequency range: 2412–2462 MHz • Max. output power: 15 dBm
METERLiNK/Bluetooth	Frequency range: 2402–2480 MHz, supports 2.1 and 4.0
Antenna	Internal
Power system	
Battery type	Rechargeable Li ion battery
Battery operating time	>2.5 hours at 25°C (+68°F) and typical use
Charging system	In camera (AC adapter or 12 V from a vehicle) or two-bay charger
Charging time	2.5 hours to 90% capacity, charging status indicated by LEDs
Charging temperature	0°C to +45°C (+32°F to +113°F), except for the Korean market: +10°C to +45°C (+50°F to +113°F)
External power operation	AC adapter 90–260 V AC, 50/60 Hz or 12 V from a vehicle (cable with a standard plug, optional)
Power management	Automatic power-off functionality, user configurable between 5 minutes, 20 minutes, and no automatic shutdown
Environmental data	
Operating temperature range	–15°C to +50°C (+5°F to +122°F)
Storage temperature range	–40 to +70°C (–40 to +158°F)
Humidity (operating and storage)	IEC 60068-2-30 / 24 hours, 95% relative humidity, 25–40°C (77–104°F) / 2 cycles

Environmental data	
EMC	<ul style="list-style-type: none"> • ETSI EN 301 489-1 (radio) • ETSI EN 301 489-17 • EN 61000-6-2 (Immunity) • EN 61000-6-3 (Emission) • FCC 47 CFR Part 15 Class B (Emission) • ICES-003
Radio spectrum	<ul style="list-style-type: none"> • ETSI EN 300 328 • FCC Part 15.247 • RSS-247 Issue 2
Encapsulation	IP 54 (IEC 60529)
Shock	25 g (IEC 60068-2-29)
Vibration	2 g (IEC 60068-2-6)
Safety	EN/UL/CSA/PSE 60950-1
Ergonomics	The viewfinder plus the 120° rotating optical block allow you to point the camera in multiple directions while maintaining a comfortable position
Physical data	
Weight	2.0 kg (4.3 lb.)
Camera size, excl. lens (L x W x H)	167.2 mm x 204.5 mm x 188.3 mm (6.6 in. x 8.0 in. x 7.4 in.)
Tripod mounting	UNC ¼"-20
Housing material	Magnesium
Warranty information	
Warranty	<ul style="list-style-type: none"> • 2 years parts and labor coverage on the camera • 5 years coverage on the battery • 10 years coverage on the detector – the most vital part of the whole camera
Shipping information	
List of contents	<ul style="list-style-type: none"> • Infrared camera with lens • Battery (2 ea.) • Battery charger • Bluetooth headset • Calibration certificate • FLIR Tools+ license card • FLIR T10xx SC kit (in separate hard transport case): <ul style="list-style-type: none"> ◦ High-speed interface ◦ USB cable (USB 3), 3 m (10 ft.) ◦ Digital I/O connector ◦ FLIR ResearchIR Max license card ◦ Printed documentation • Hard transport case • HDMI-HDMI cable • Lens cap • Memory card • Neck strap • Power supply, including multi-plugs • Printed documentation • USB cable, Std A to Micro-B
EAN-13	7332558010433
UPC-12	845188011086
Country of origin	Sweden

Supplies & accessories:

- T199064; IR lens f=36mm (28°) with case
- T199066; IR lens f=21.2mm (45°) with case
- T199077; IR lens f=83.4mm (12°) with case
- T910814; Power supply, incl. multi plugs
- T198126; Battery charger, incl. power supply with multi plugs T6xx
- T199364ACC; Battery Li-ion 3.65 V, 8.5 Ah, 32 Wh
- T911650ACC; Memory card SD Card 8 GB
- T198509; Cigarette lighter adapter kit, 12 VDC, 1.2 m/3.9 ft.
- T910930ACC; HDMI type C to DVI cable 1.5 m
- T910891ACC; HDMI type C to HDMI type A cable 1.5 m
- 72500-0002; FLIR T10xx SC kit
- T198497; Large eyecup
- T197771ACC; Bluetooth Headset
- T911093; Tool belt
- T198533; USB cable Std A <-> Micro B
- T198586; FLIR Reporter Professional (license only)
- T198584; FLIR Tools
- T198583; FLIR Tools+ (download card incl. license key)
- DSW-10000; FLIR IR Camera Player
- APP-10002; FLIR Tools Mobile (Android Application)
- APP-10003; FLIR Tools Mobile (iPad/iPhone Application)
- APP-10004; FLIR Tools (MacOS Application)
- T198697; FLIR ResearchIR Max + HSDR 4 (hardware sec. dev.)
- T199014; FLIR ResearchIR Max + HSDR 4 (printed license key)
- T199044; FLIR ResearchIR Max + HSDR 4 Upgrade (printed license key)
- T198696; FLIR ResearchIR Max 4 (hardware sec. dev.)
- T199013; FLIR ResearchIR Max 4 (printed license key)
- T199043; FLIR ResearchIR Max 4 Upgrade (printed license key)
- T198731; FLIR ResearchIR Standard 4 (hardware sec. dev.)
- T199012; FLIR ResearchIR Standard 4 (printed license key)
- T199042; FLIR ResearchIR Standard 4 Upgrade (printed license key)
- T199233; FLIR Atlas SDK for .NET
- T199234; FLIR Atlas SDK for MATLAB

30.22 IR lens, f=36 mm (28°) with case

P/N: T199064

Rev.: 30226

General description	
The standard 28° lens is suitable for the majority of applications.	
Imaging and optical data	
Field of view (FOV)	28° × 21° (34.5° diagonal)
Minimum focus distance	0.4 m (1.32 ft.)
Focal length	36 mm (1.42 in.)
Spatial resolution (IFOV)	0.47 mrad
Lens identification	Automatic
F-number	1.15
Number of lenses	4 (4 asph)
Distortion	2.8%
Physical data	
Weight	0.730 kg (1.61 lb.)
Size (L × D)	93.4 × 91 mm (3.68 × 3.58 in.)
Front lens diameter	64 mm (2.5 in.)
Shipping information	
Packaging, type	Cardboard box
List of contents	<ul style="list-style-type: none"> • Lens • Lens case • Front lens cap • Rear lens cap • Mounting instruction
Packaging, weight	1.1 kg (2.4 lb.)
Packaging, size	173 × 135 × 135 mm (6.81 × 5.31 × 5.31 in.)
EAN-13	7332558010983
UPC-12	845188011833
Country of origin	Sweden

Compatible with the following products

- 72502-0501; FLIR T1010 12°
- 72502-0502; FLIR T1010 28°
- 72502-0503; FLIR T1010 45°
- 72501-0101; FLIR T1020 12°
- 72501-0102; FLIR T1020 28°
- 72501-0104; FLIR T1020 28° and 12°
- 72501-0105; FLIR T1020 28° and 45°
- 72501-0106; FLIR T1020 28°, 12°, and 45°
- 72501-0103; FLIR T1020 45°
- 72501-0201; FLIR T1030sc 12°
- 72501-0202; FLIR T1030sc 28°
- 72501-0203; FLIR T1030sc 45°
- 72501-0301; FLIR T1040 12°
- 72501-0302; FLIR T1040 28°
- 72501-0303; FLIR T1040 45°
- 72501-0401; FLIR T1050sc 12°

- 72501-0402; FLIR T1050sc 28°
- 72501-0403; FLIR T1050sc 45°

30.23 Close-up lens 3× (51 μm) with case

P/N: T199065

Rev.: 30226

General description	
The close-up lens is attached to the standard 28° IR lens and provides three times magnification. The close-up lens is intended for R&D usage or development purposes. As an example, for studies of PCBs and small electronic components.	
Imaging and optical data	
Field of view (FOV)	52° × 40° (66° diagonal)
Magnifying factor	3×
Working distance	97 mm (3.8 in.)
Depth of field	0.5 mm (0.02 in.)
Focal length	50 mm (2.0 in.)
Spatial resolution (IFOV)	51 μm
Lens identification	No
F-number	1.15
Number of lenses	2 (2 asph)
Distortion	0.4%
Physical data	
Weight	0.620 kg (1.37 lb.)
Size (L × D)	127.5 × 91 mm (5.02 × 3.58 in.)
Front lens diameter	76 mm (3.0 in.)
Shipping information	
Packaging, type	Cardboard box
List of contents	<ul style="list-style-type: none"> • Lens • Lens case • Front lens cap • Rear lens cap • Mounting instruction
Packaging, weight	0.96 kg (2.1 lb.)
Packaging, size	173 × 135 × 135 mm (6.81 × 5.31 × 5.31 in.)
EAN-13	7332558011003
UPC-12	845188011857
Country of origin	Sweden

Compatible with the following products:

- 72501-0102; FLIR T1020 28°
- 72501-0104; FLIR T1020 28° and 12°
- 72501-0105; FLIR T1020 28° and 45°
- 72501-0106; FLIR T1020 28°, 12°, and 45°
- 72501-0202; FLIR T1030sc 28°
- 72501-0302; FLIR T1040 28°
- 72501-0402; FLIR T1050sc 28°

30.24 IR lens f=21.2 mm (45°) with case

P/N: T199066

Rev.: 30226

General description	
The 45° has a field of view approximately two times that of the standard 28° lens. This wide angle lens is suitable for cramped situations where the operator cannot step farther back from the object.	
Imaging and optical data	
Field of view (FOV)	45° × 34° (55.2° diagonal)
Minimum focus distance	0.2 m (0.66 ft.)
Focal length	21.2 mm (0.83 in.)
Spatial resolution (IFOV)	0.80 mrad
Lens identification	Automatic
F-number	1.1
Number of lenses	4 (4 asph)
Distortion	1.71%
Physical data	
Weight	0.754 kg (1.66 lb.)
Size (L × D)	96.9 × 91 mm (3.82 × 3.58 in.)
Front lens diameter	59 mm (2.3 in.)
Shipping information	
Packaging, type	Cardboard box
List of contents	<ul style="list-style-type: none"> • Lens • Lens case • Front lens cap • Rear lens cap • Mounting instruction
Packaging, weight	1.1 kg (2.4 lb.)
Packaging, size	173 × 135 × 135 mm (6.81 × 5.31 × 5.31 in.)
EAN-13	7332558010990
UPC-12	845188011840
Country of origin	Sweden

Compatible with the following products

- 72502-0501; FLIR T1010 12°
- 72502-0502; FLIR T1010 28°
- 72502-0503; FLIR T1010 45°
- 72501-0101; FLIR T1020 12°
- 72501-0102; FLIR T1020 28°
- 72501-0104; FLIR T1020 28° and 12°
- 72501-0105; FLIR T1020 28° and 45°
- 72501-0106; FLIR T1020 28°, 12°, and 45°
- 72501-0103; FLIR T1020 45°
- 72501-0201; FLIR T1030sc 12°
- 72501-0202; FLIR T1030sc 28°
- 72501-0203; FLIR T1030sc 45°
- 72501-0301; FLIR T1040 12°
- 72501-0302; FLIR T1040 28°
- 72501-0303; FLIR T1040 45°

- 72501-0401; FLIR T1050sc 12°
- 72501-0402; FLIR T1050sc 28°
- 72501-0403; FLIR T1050sc 45°

30.25 IR lens f=83.4 mm (12°) with case

P/N: T199077

Rev.: 39047

General description	
The 12° lens provides approximately two times magnification compared to the standard 28° lens. This lens is ideal for small or distant targets, such as overhead power lines.	
Imaging and optical data	
Field of view (FOV)	12° × 9° (15.2° diagonal)
Minimum focus distance	1.3 m (4.26 ft.)
Focal length	83.4 mm (3.28 in.)
Spatial resolution (IFOV)	0.20 mrad
Lens identification	Automatic
F-number	1.2
Number of lenses	5 (5 asph)
Distortion	2.2%
Physical data	
Weight	1.06 kg (2.34 lb.)
Size (L × D)	134.1 × 100.5 mm (5.28 × 3.96 in.)
Front lens diameter	75 mm (3.0 in.)
Shipping information	
Packaging, type	Cardboard box
List of contents	<ul style="list-style-type: none"> • Lens • Lens case • Front lens cap • Rear lens cap • Mounting instruction
Packaging, weight	1.4 kg (3.1 lb.)
Packaging, size	212 × 150 × 150 mm (8.35 × 5.91 × 5.91 in.)
EAN-13	7332558011010
UPC-12	845188011864
Country of origin	Sweden

Compatible with the following products

- 72502-0501; FLIR T1010 12°
- 72502-0502; FLIR T1010 28°
- 72502-0503; FLIR T1010 45°
- 72501-0101; FLIR T1020 12°
- 72501-0102; FLIR T1020 28°
- 72501-0104; FLIR T1020 28° and 12°
- 72501-0105; FLIR T1020 28° and 45°
- 72501-0106; FLIR T1020 28°, 12°, and 45°
- 72501-0103; FLIR T1020 45°
- 72501-0201; FLIR T1030sc 12°
- 72501-0202; FLIR T1030sc 28°
- 72501-0203; FLIR T1030sc 45°
- 72501-0301; FLIR T1040 12°
- 72501-0302; FLIR T1040 28°
- 72501-0303; FLIR T1040 45°

- 72501-0401; FLIR T1050sc 12°
- 72501-0402; FLIR T1050sc 28°
- 72501-0403; FLIR T1050sc 45°

30.26 FLIR T10xx SC kit

P/N: 72500-0002

Rev.: 36742

General description	
The FLIR T10xx SC kit is intended for R&D usage and development purposes. The kit includes a high-speed interface (HSI) box, which enables streaming of fully radiometric and uncompressed video from a FLIR T10xx series camera to a PC running the FLIR ResearchIR Max software.	
Communication	
Interfaces	<ul style="list-style-type: none"> • USB 3 Vision • Digital I/O • Proprietary FLIR interface
Image streaming	<ul style="list-style-type: none"> • Up to 120 Hz full frame • Up to 240 Hz by windowing
Image formats	<ul style="list-style-type: none"> • Unfiltered, uncompressed 14 bit radiometric raw data • Lossless, maximal sensitivity
Electronics and data rate	
Video streaming	
Windowing	<ul style="list-style-type: none"> • 30 Hz: 1024 × 768 (full image height) • Based on 30 Hz: 120 Hz windowing 1024 × 192 (¼ of full image height), for range -40 to +150°C (-40 to +302°F) • 120 Hz: 1024 × 768 (full image height) • Based on 120 Hz: 240 Hz windowing 1024 × 384 (½ of full image height), for range 0 to +650°C (+32 to +1202°F) and range +300 to +2000°C (+572 to +3632°F)
Power system	
Power, HSI box	Powered from PC via USB 3
Physical data	
Weight, HSI box	0.405 kg (0.893 lb.)
Weight, USB cable	0.135 kg (0.298 lb.)
Size (L × W × H), HSI box	125 × 72.4 × 56.7 mm (4.92 × 2.85 × 2.23 in.)
Mounting, HSI box	Tripod mount, velcro straps
Shipping information	
Packaging, type	Cardboard box
List of contents	<ul style="list-style-type: none"> • High-speed interface • Hard transport case • USB cable (USB 3), 3 m (10 ft.) • Digital I/O connector • FLIR ResearchIR Max license card • Printed documentation
Packaging, weight	2.1 kg (4.6 lb.)
Packaging, size	303 × 206 × 128 mm (11.9 × 18.1 × 5.0 in.)
EAN-13	7332558011041

Shipping information	
UPC-12	845188011888
Country of origin	Sweden

- 72501-0201; FLIR T1030sc 12°
- 72501-0202; FLIR T1030sc 28°
- 72501-0203; FLIR T1030sc 45°
- 72501-0401; FLIR T1050sc 12°
- 72501-0402; FLIR T1050sc 28°
- 72501-0403; FLIR T1050sc 45°

[See next page]

Camera housing

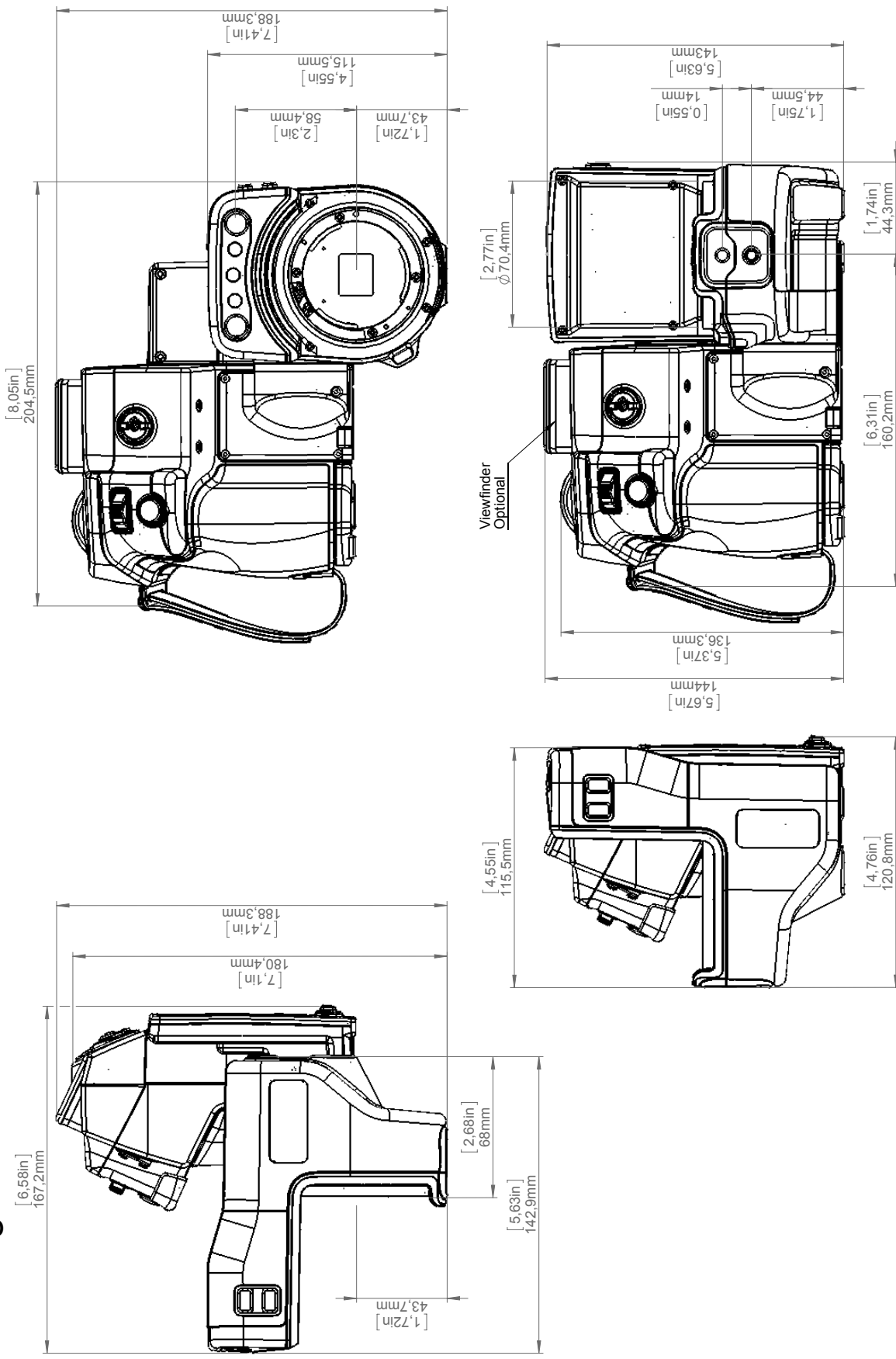

© 2012, FLIR Systems, Inc. All rights reserved worldwide. No part of this drawing may be reproduced, stored in a retrieval system, or transmitted in any form, or by any means, electronic, mechanical, photocopying, recording, or otherwise, without written permission from FLIR Systems, Inc. Specifications subject to change without further notice. Dimensional data is based on nominal values. Products may be subject to regional market considerations. License procedures may apply. Product may be subject to US Export Regulations. Please refer to exportquestions@flir.com with any questions. Diversion contrary to US law is prohibited.

Modified 2015-09-17	Check JOTA	Drawn by R&D Thermography	FLIR
Denomination Basic dimensions FLIR T10xx		Size A3	Sheet 1(7)
Scale 1:2		Drawing No. T128849	Size D

IR-LENS 12° (f=83,4mm)

[8,63in]
219,2mm

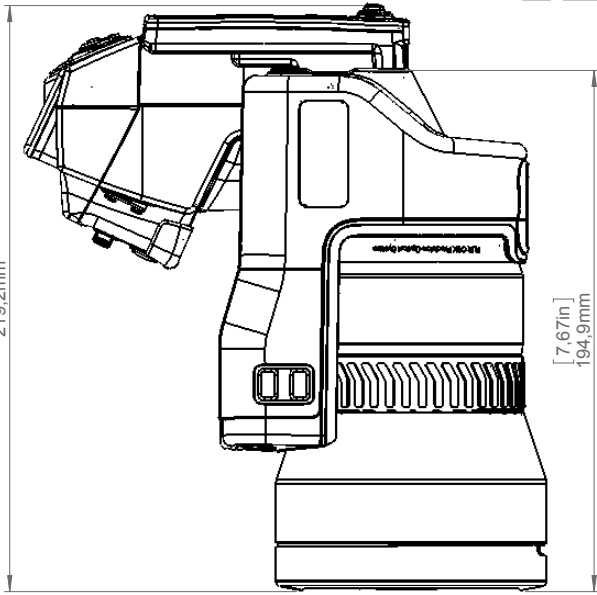

[7,67in]
194,9mm

[8,29in]
210,4mm

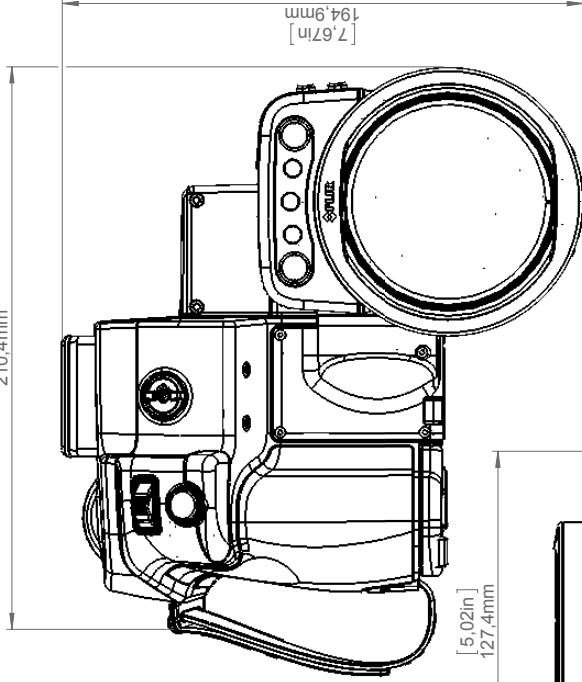

[7,67in]
194,9mm

[3,96in]
100,5mm

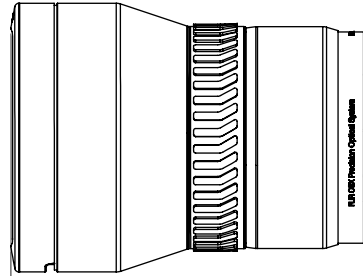

[5,28in]
134,1mm

[5,19in]
131,9mm

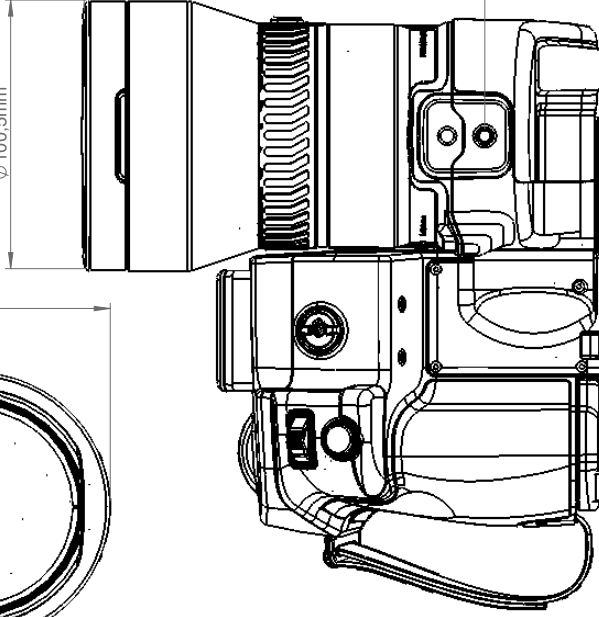

[5,02in]
127,4mm

[5,9in]
149,9mm

		Drawing No. T128849
Modified 2015-09-17 Denomination	Check JOTA	Drawn by R&D Thermography
Size A3	Scale 1:2	Sheet 2(7)
Basic dimensions FLIR T10xx		
		Drawing No. T128849
		Size D

© 2012, FLIR Systems, Inc. All rights reserved worldwide. No part of this drawing may be reproduced, stored in a retrieval system, or transmitted in any form, or by any means, electronic, mechanical, photocopying, recording, or otherwise, without written permission from FLIR Systems, Inc. Specifications subject to change without further notice. Dimensional data is based on nominal values. Products may be subject to regional market considerations. License procedures may apply. Product may be subject to US Export Regulations. Please refer to exportquestions@flir.com with any questions. Division contrary to US law is prohibited.

IR-LENS 28° (f=36mm)

[8,1in]
205,7mm

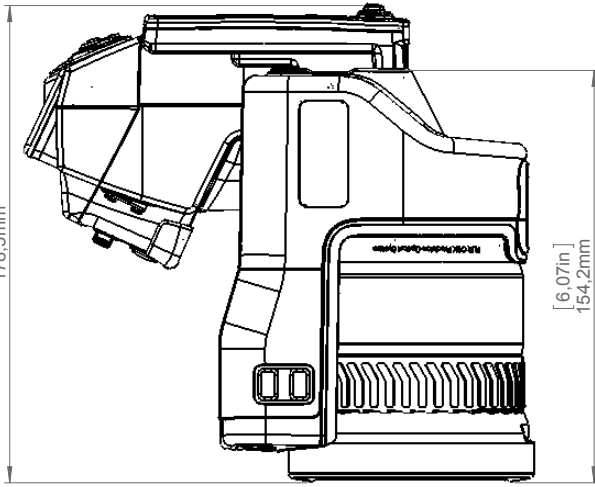
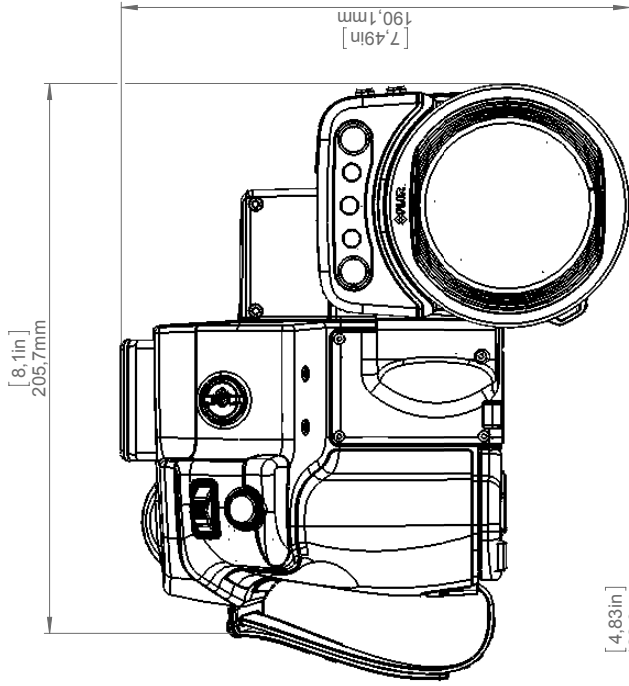

[4,83in]
122,6mm

[3,58in]
Ø91mm

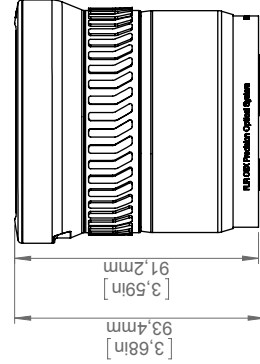
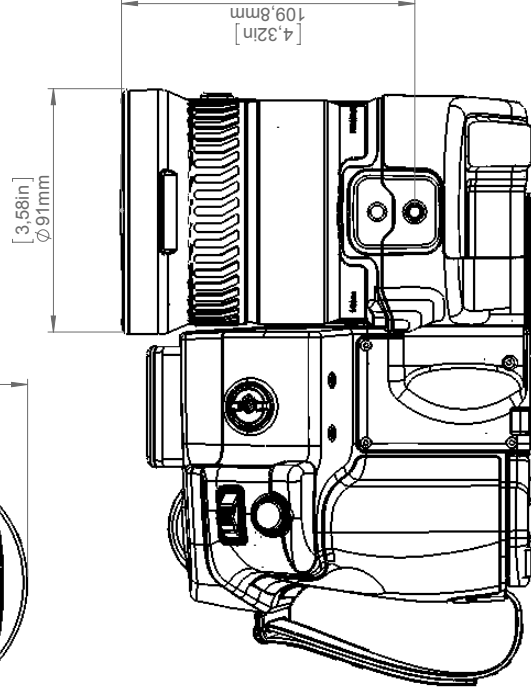
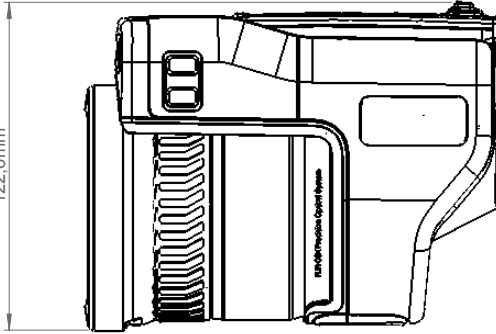

		Drawing No. T128849
Modified 2015-09-17 Denomination	Check JOTA	Drawn by R&D Thermography
Size A3		Sheet 3(7)
Scale 1:2		Size D
Basic dimensions FLIR T10xx		

© 2012, FLIR Systems, Inc. All rights reserved worldwide. No part of this drawing may be reproduced, stored in a retrieval system, or transmitted in any form, or by any means, electronic, mechanical, photocopying, recording, or otherwise, without written permission from FLIR Systems, Inc. Specifications subject to change without further notice. Dimensional data is based on nominal values. Products may be subject to regional market considerations. License procedures may apply. Product may be subject to US Export Regulations. Please refer to exportquestions@flir.com with any questions. Diversion contrary to US law is prohibited.

IR-LENS 45° (f=21,2mm)

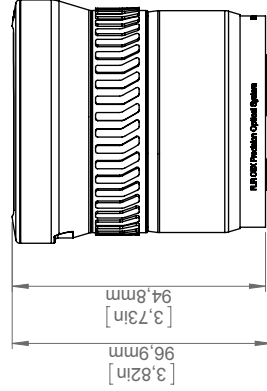
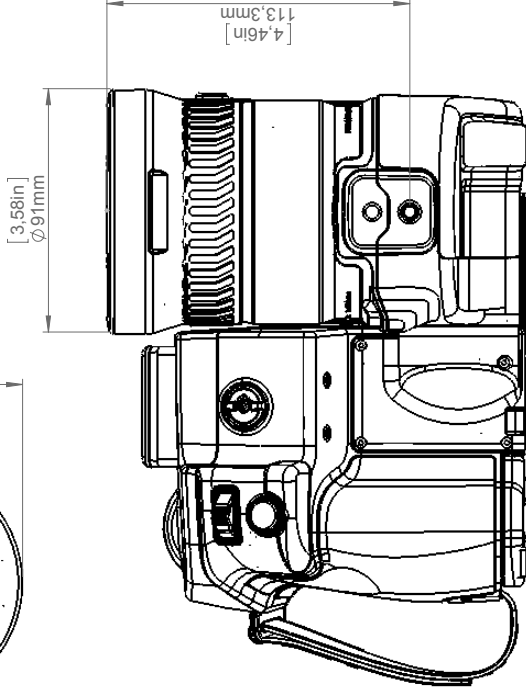
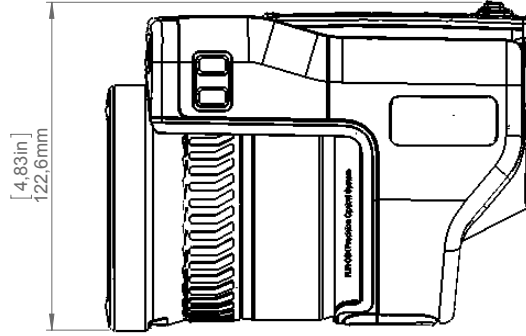
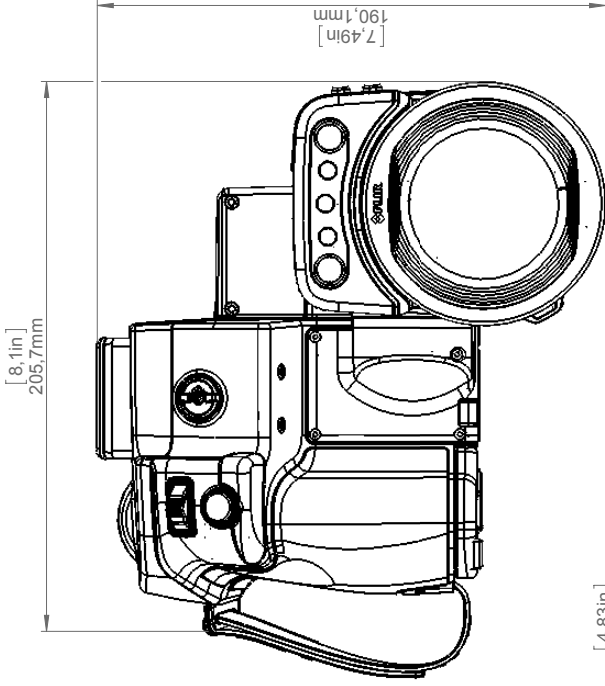
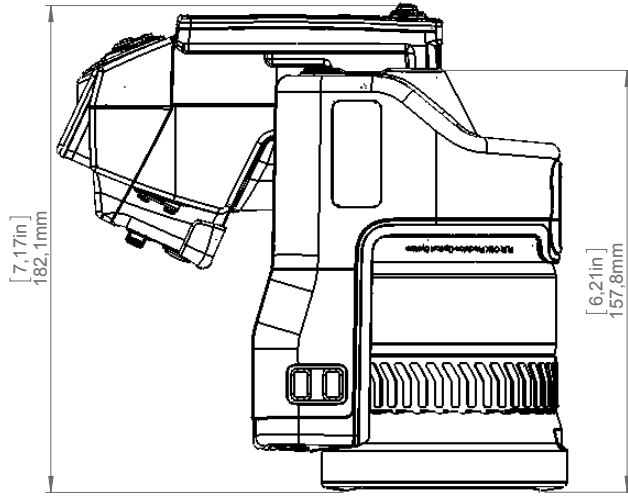

Modified 2015-09-17
Denomination

Check JOTA

Drawn by R&D Thermography

Size A3

Basic dimensions FLIR T10xx

Scale 1:2

Sheet 4(7)

Drawing No. T128849



IR-LENS CLOSE-UP (3X)

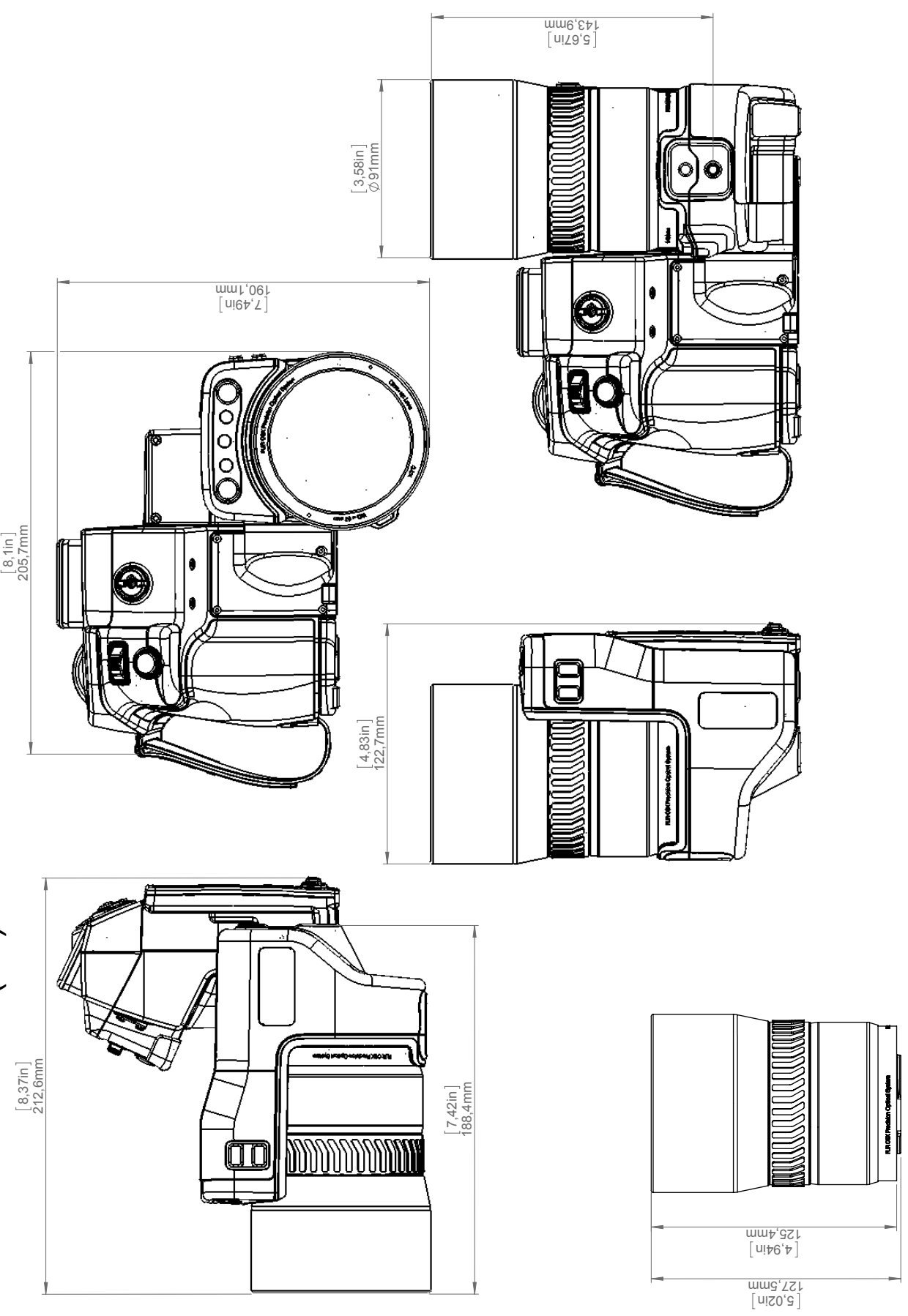

© 2012, FLIR Systems, Inc. All rights reserved worldwide. No part of this drawing may be reproduced, stored in a retrieval system, or transmitted in any form, or by any means, electronic, mechanical, photocopying, recording, or otherwise, without written permission from FLIR Systems, Inc. Specifications subject to change without further notice. Dimensional data is based on nominal values. Products may be subject to regional market considerations. License procedures may apply. Product may be subject to US Export Regulations. Please refer to exportquestions@flir.com with any questions. Division contrary to US law is prohibited.

Modified	Check	Drawn by	FLIR
2015-09-17	JOTA	R&D Thermography	
Denomination			
Basic dimensions FLIR T10xx			Sheet 5(7)
Size	Scale	Drawing No.	Size
A3	1:2	T128849	D

Battery Charger

© 2012, FLIR Systems, Inc. All rights reserved worldwide. No part of this drawing may be reproduced, stored in a retrieval system, or transmitted in any form, or by any means, electronic, mechanical, photocopying, recording, or otherwise, without written permission from FLIR Systems, Inc. Specifications subject to change without further notice. Dimensional data is based on nominal values. Products may be subject to regional market considerations. License procedures may apply. Product may be subject to US Export Regulations. Please refer to exportquestions@flir.com with any questions. Diversion contrary to US law is prohibited.

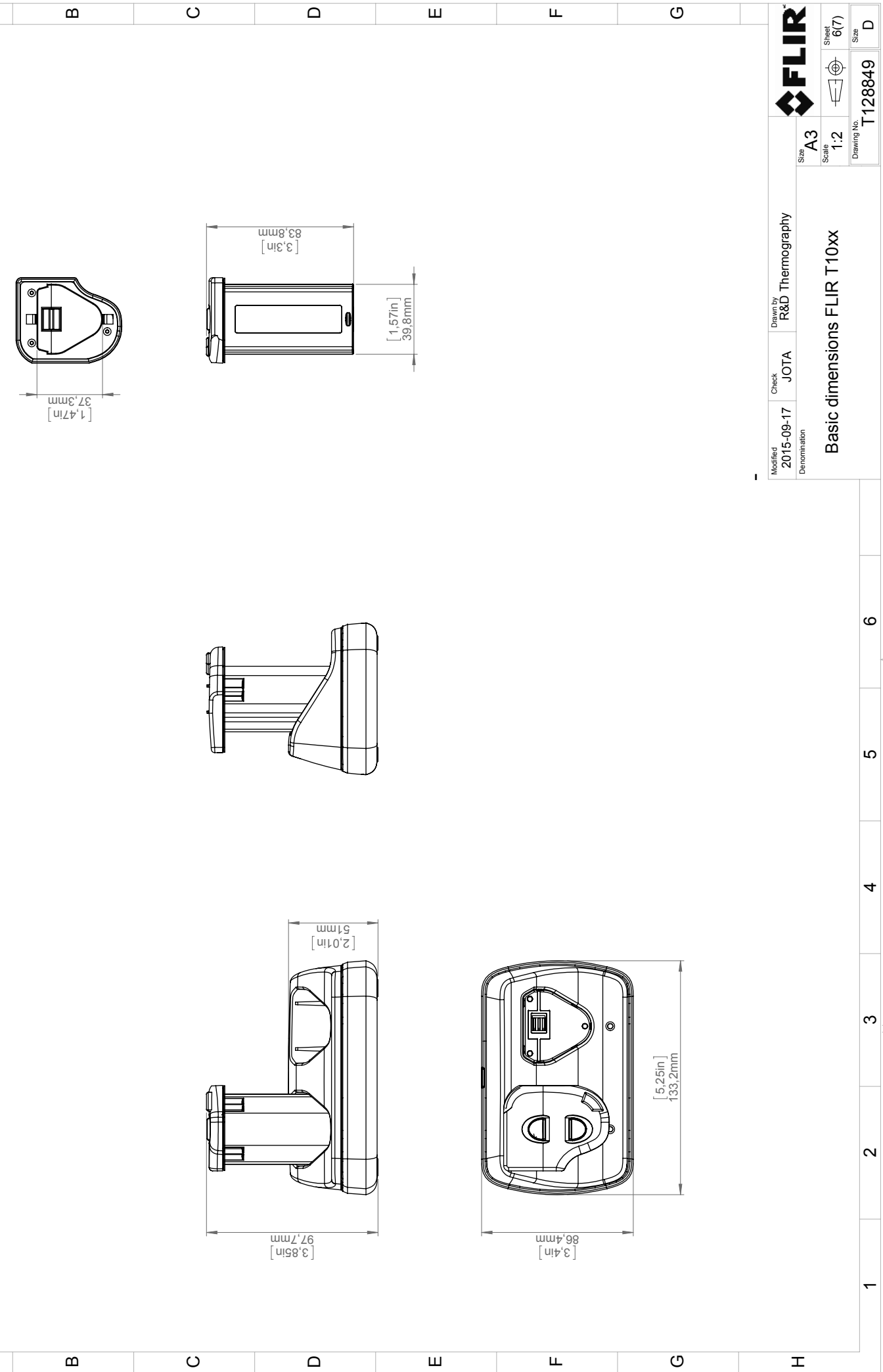

Modified 2015-09-17	Check JOTA	Drawn by R&D Thermography	FLIR
Denomination Basic dimensions FLIR T10xx			Size A3
			Scale 1:2
			Sheet 6(7)
			Drawing No. T128849
			Size D

High-Speed Interface

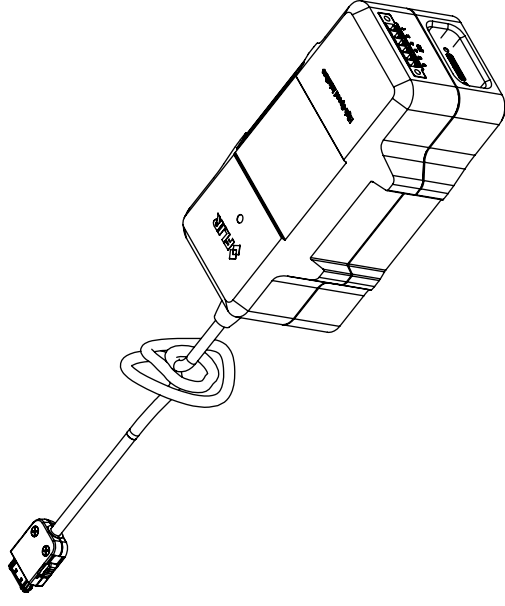
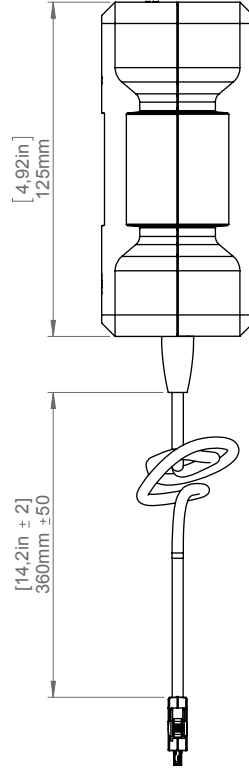
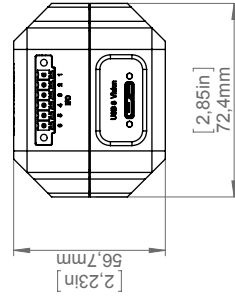
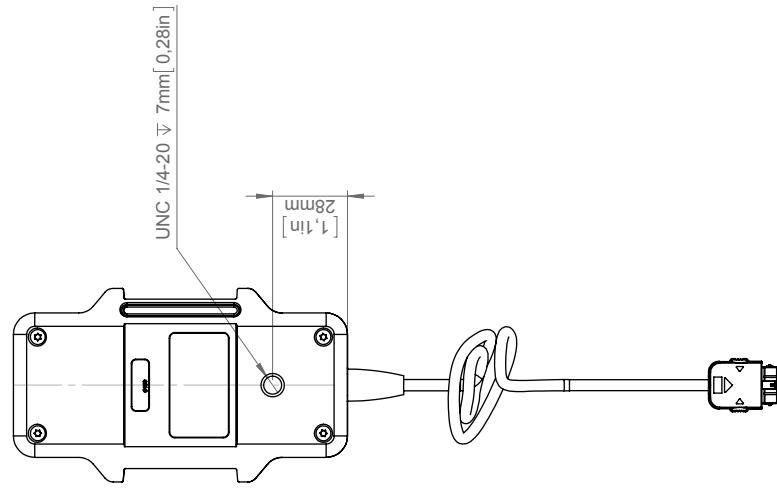

Modified 2015-09-17 Denomination	Check JOTA	Drawn by R&D Thermography	FLIR
Basic dimensions FLIR T10xx		Size A3	Sheet 7(7)
		Scale 1:2	Size T128849
		Drawing No.	

32.1 Pin configuration for the Digital I/O connector on the HSI box

Pin	Function	Data
1	IN 1	opto-isolated, 0–1.5 V = low, 3–25 V = high
2	IN 2	opto-isolated, 0–1.5 V = low, 3–25 V = high
3	OUT 1	opto-isolated, ON = supply (max. 100 mA), OFF = open
4	OUT 2	opto-isolated, ON = supply (max. 100 mA), OFF = open
5	Supply VCC	6–24 VDC, max. 200 mA
6	Supply Gnd	Gnd

Note Cables for digital I/O ports should be 100 m (328') maximum.

[See next page]

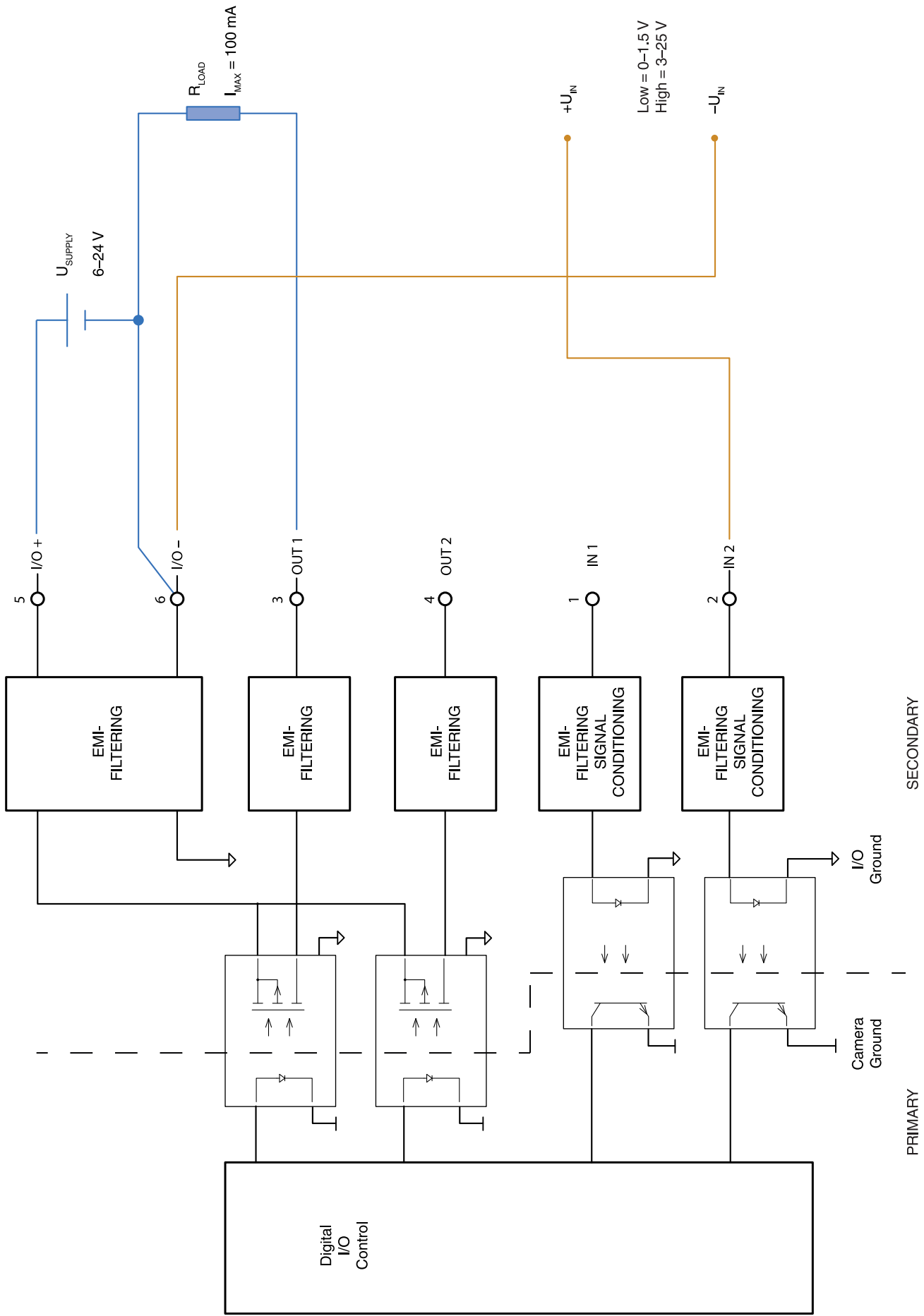

[See next page]

November 13, 2017 Täby, Sweden

AQ320228

CE Declaration of Conformity – EU Declaration of Conformity

Product: FLIR T10XX -series

Name and address of the manufacturer:

FLIR Systems AB
PO Box 7376
SE-187 15 Täby, Sweden

This declaration of conformity is issued under the sole responsibility of the manufacturer.
The object of the declaration: FLIR T10XX -series (Product Model Name FLIR-T7250).
The object of the declaration described above is in conformity with the relevant Union harmonisation legislation:

Directives:

Directive	2014/30/EU	Electromagnetic Compatibility
Directive	2014/35/EU	Low Voltage Directive
Directive	2012/19/EU	Waste electrical and electric equipment
Directive	2014/53/EU	Radio Equipment Directive (RED)
Directive	1999/519/EC	Limitation of exposure to electromagnetic fields (SAR)
Directive	2011/65/EU	RoHS

Standards:

Emission:	EN 61000-6-3:2007/A1:2011	Electromagnetic Compatibility Generic
	EN 301489-1:2011 v1.9.2	ERM – EMC for radio equipment
	EN 301489-17:2009 v2.2.1	ERM – EMC Wideband data
Immunity:	EN 61000-6-2:2005	Electromagnetic Compatibility Generic
	EN 301489-1:2011 v1.9.2	ERM – EMC for radio equipment
	EN 301489-17:2009 v2.2.1	ERM – EMC Wideband data
Laser:	EN 60825-1	Safety of laser products
Radio:	ETSI EN 300 328 v2.1.1	Harmonized EN covering essential requirements of the RED Directive
	EN 303 413 v1.1.0	Radio Spectrum Efficiency (gps)
SAR:	EN 50566:2013	Handheld and body mounted wireless
RoHS:	EN 50581:2012	Technical documentation
Safety:	IEC 60950-1:2005+A1:2009	Information technology equipment
	EN 60950-1:2006+A11:2009+A1:2010+AC:2011+A12:2011	

FLIR Systems AB
Quality AssuranceLea Dabiri
Quality Manager

35.1 Camera housing, cables, and other items

35.1.1 Liquids

Use one of these liquids:

- Warm water
- A weak detergent solution

35.1.2 Equipment

A soft cloth

35.1.3 Procedure

Follow this procedure:

1. Soak the cloth in the liquid.
2. Twist the cloth to remove excess liquid.
3. Clean the part with the cloth.

	CAUTION
Do not apply solvents or similar liquids to the camera, the cables, or other items. This can cause damage.	

35.2 Infrared lens

35.2.1 Liquids

Use one of these liquids:

- A commercial lens cleaning liquid with more than 30% isopropyl alcohol.
- 96% ethyl alcohol (C₂H₅OH).

35.2.2 Equipment

Cotton wool

	CAUTION
If you use a lens cleaning cloth it must be dry. Do not use a lens cleaning cloth with the liquids that are given in section 35.2.1 above. These liquids can cause material on the lens cleaning cloth to become loose. This material can have an unwanted effect on the surface of the lens.	

35.2.3 Procedure

Follow this procedure:

1. Soak the cotton wool in the liquid.
2. Twist the cotton wool to remove excess liquid.
3. Clean the lens one time only and discard the cotton wool.

	WARNING
Make sure that you read all applicable MSDS (Material Safety Data Sheets) and warning labels on containers before you use a liquid: the liquids can be dangerous.	

	CAUTION
<ul style="list-style-type: none"> • Be careful when you clean the infrared lens. The lens has a delicate anti-reflective coating. • Do not clean the infrared lens too vigorously. This can damage the anti-reflective coating. 	

35.3 Infrared detector

35.3.1 General

Even small amounts of dust on the infrared detector can result in major blemishes in the image. To remove any dust from the detector, follow the procedure below.

Note

- This section only applies to cameras where removing the lens exposes the infrared detector.
- In some cases the dust cannot be removed by following this procedure: the infrared detector must be cleaned mechanically. This mechanical cleaning must be carried out by an authorized service partner.



CAUTION

In Step 2 below, do not use pressurized air from pneumatic air circuits in a workshop, etc., as this air usually contains oil mist to lubricate pneumatic tools.

35.3.2 Procedure

Follow this procedure:

1. Remove the lens from the camera.
2. Use pressurized air from a compressed air canister to blow off the dust.

36.1 Moisture & water damage

36.1.1 General

It is often possible to detect moisture and water damage in a house by using an infrared camera. This is partly because the damaged area has a different heat conduction property and partly because it has a different thermal capacity to store heat than the surrounding material.

Many factors can come into play as to how moisture or water damage will appear in an infrared image.

For example, heating and cooling of these parts takes place at different rates depending on the material and the time of day. For this reason, it is important that other methods are used as well to check for moisture or water damage.

36.1.2 Figure

The image below shows extensive water damage on an external wall where the water has penetrated the outer facing because of an incorrectly installed window ledge.

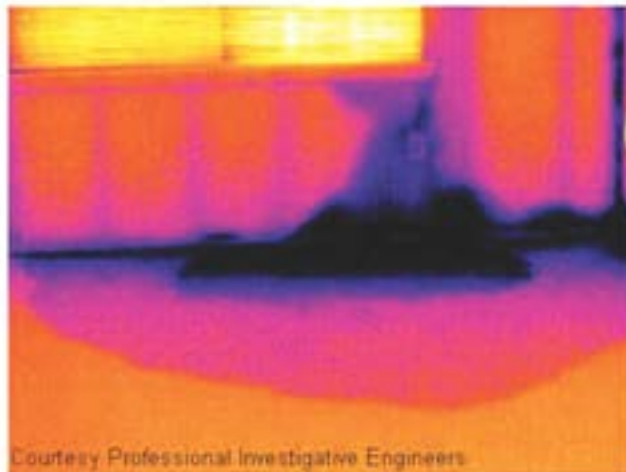

36.2 Faulty contact in socket

36.2.1 General

Depending on the type of connection a socket has, an improperly connected wire can result in local temperature increase. This temperature increase is caused by the reduced contact area between the connection point of the incoming wire and the socket, and can result in an electrical fire.

A socket's construction may differ dramatically from one manufacturer to another. For this reason, different faults in a socket can lead to the same typical appearance in an infrared image.

Local temperature increase can also result from improper contact between wire and socket, or from difference in load.

36.2.2 Figure

The image below shows a connection of a cable to a socket where improper contact in the connection has resulted in local temperature increase.

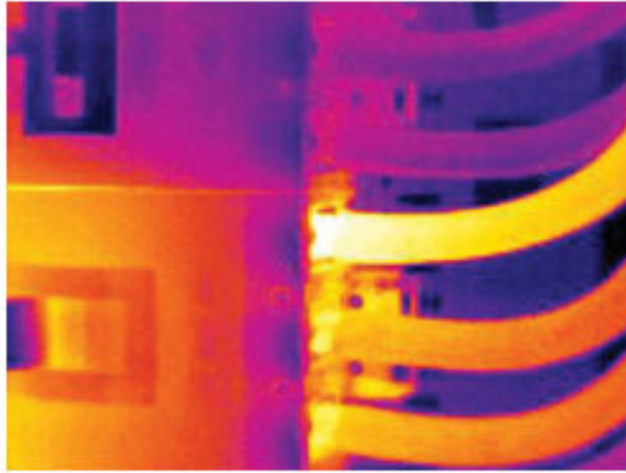

36.3 Oxidized socket

36.3.1 General

Depending on the type of socket and the environment in which the socket is installed, oxides may occur on the socket's contact surfaces. These oxides can lead to locally increased resistance when the socket is loaded, which can be seen in an infrared image as local temperature increase.

A socket's construction may differ dramatically from one manufacturer to another. For this reason, different faults in a socket can lead to the same typical appearance in an infrared image.

Local temperature increase can also result from improper contact between a wire and socket, or from difference in load.

36.3.2 Figure

The image below shows a series of fuses where one fuse has a raised temperature on the contact surfaces against the fuse holder. Because of the fuse holder's blank metal, the temperature increase is not visible there, while it is visible on the fuse's ceramic material.

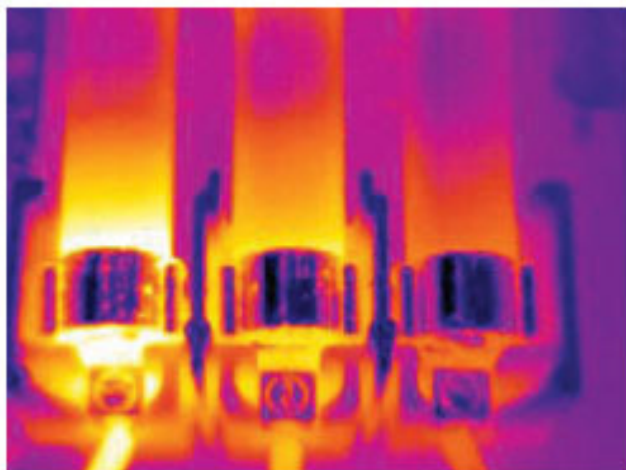

36.4 Insulation deficiencies

36.4.1 General

Insulation deficiencies may result from insulation losing volume over the course of time and thereby not entirely filling the cavity in a frame wall.

An infrared camera allows you to see these insulation deficiencies because they either have a different heat conduction property than sections with correctly installed insulation, and/or show the area where air is penetrating the frame of the building.

When you are inspecting a building, the temperature difference between the inside and outside should be at least 10°C (18°F). Studs, water pipes, concrete columns, and similar components may resemble an insulation deficiency in an infrared image. Minor differences may also occur naturally.

36.4.2 Figure

In the image below, insulation in the roof framing is lacking. Due to the absence of insulation, air has forced its way into the roof structure, which thus takes on a different characteristic appearance in the infrared image.

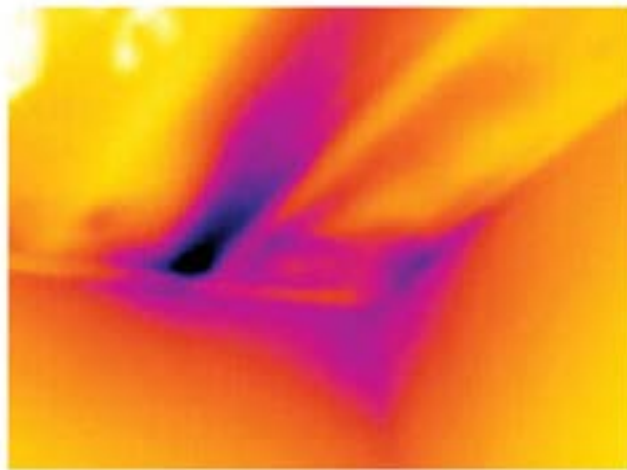

36.5 Draft

36.5.1 General

Draft can be found under baseboards, around door and window casings, and above ceiling trim. This type of draft is often possible to see with an infrared camera, as a cooler airstream cools down the surrounding surface.

When you are investigating draft in a house, there should be sub-atmospheric pressure in the house. Close all doors, windows, and ventilation ducts, and allow the kitchen fan to run for a while before you take the infrared images.

An infrared image of draft often shows a typical stream pattern. You can see this stream pattern clearly in the picture below.

Also keep in mind that drafts can be concealed by heat from floor heating circuits.

36.5.2 Figure

The image below shows a ceiling hatch where faulty installation has resulted in a strong draft.

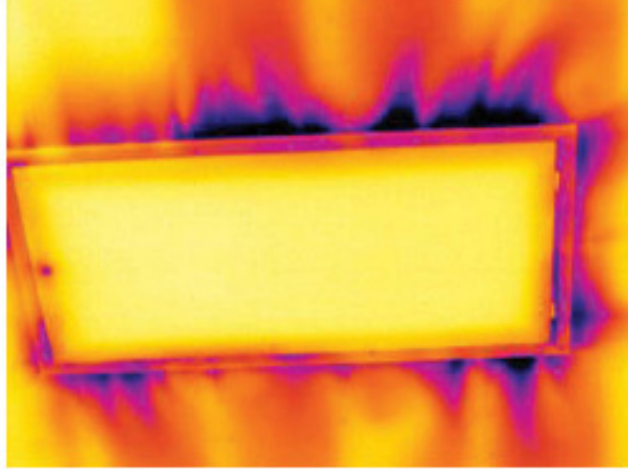

FLIR Systems was established in 1978 to pioneer the development of high-performance infrared imaging systems, and is the world leader in the design, manufacture, and marketing of thermal imaging systems for a wide variety of commercial, industrial, and government applications. Today, FLIR Systems embraces five major companies with outstanding achievements in infrared technology since 1958—the Swedish AGEMA Infrared Systems (formerly AGA Infrared Systems), the three United States companies Indigo Systems, FSI, and Inframetrics, and the French company Cedip.

Since 2007, FLIR Systems has acquired several companies with world-leading expertise in sensor technologies:

- Extech Instruments (2007)
- Ifara Tecnologías (2008)
- Salvador Imaging (2009)
- OmniTech Partners (2009)
- Directed Perception (2009)
- Raymarine (2010)
- ICx Technologies (2010)
- TackTick Marine Digital Instruments (2011)
- Aerius Photonics (2011)
- Lorex Technology (2012)
- Traficon (2012)
- MARSS (2013)
- DigitalOptics micro-optics business (2013)
- DVTEL (2015)
- Point Grey Research (2016)
- Prox Dynamics (2016)

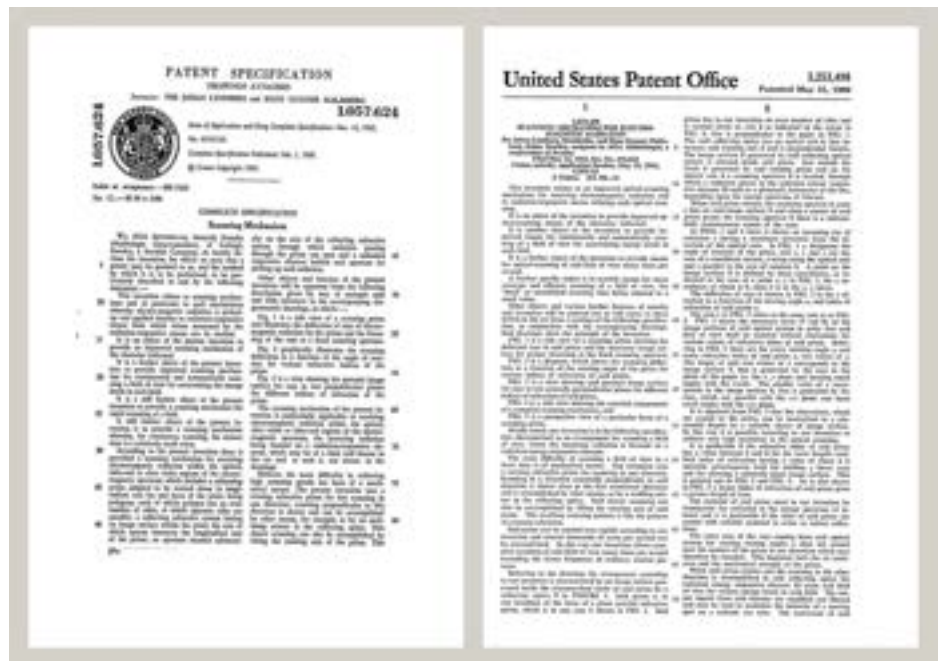

Figure 37.1 Patent documents from the early 1960s

FLIR Systems has three manufacturing plants in the United States (Portland, OR, Boston, MA, Santa Barbara, CA) and one in Sweden (Stockholm). Since 2007 there is also a manufacturing plant in Tallinn, Estonia. Direct sales offices in Belgium, Brazil, China, France, Germany, Great Britain, Hong Kong, Italy, Japan, Korea, Sweden, and the USA—together with a worldwide network of agents and distributors—support our international customer base.

FLIR Systems is at the forefront of innovation in the infrared camera industry. We anticipate market demand by constantly improving our existing cameras and developing new ones. The company has set milestones in product design and development such as the introduction of the first battery-operated portable camera for industrial inspections, and the first uncooled infrared camera, to mention just two innovations.



Figure 37.2 1969: Thermovision Model 661. The camera weighed approximately 25 kg (55 lb.), the oscilloscope 20 kg (44 lb.), and the tripod 15 kg (33 lb.). The operator also needed a 220 VAC generator set, and a 10 L (2.6 US gallon) jar with liquid nitrogen. To the left of the oscilloscope the Polaroid attachment (6 kg (13 lb.)) can be seen.



Figure 37.3 2015: FLIR One, an accessory to iPhone and Android mobile phones. Weight: 90 g (3.2 oz.).

FLIR Systems manufactures all vital mechanical and electronic components of the camera systems itself. From detector design and manufacturing, to lenses and system electronics, to final testing and calibration, all production steps are carried out and supervised by our own engineers. The in-depth expertise of these infrared specialists ensures the accuracy and reliability of all vital components that are assembled into your infrared camera.

37.1 More than just an infrared camera

At FLIR Systems we recognize that our job is to go beyond just producing the best infrared camera systems. We are committed to enabling all users of our infrared camera systems to work more productively by providing them with the most powerful camera–software combination. Especially tailored software for predictive maintenance, R & D, and process monitoring is developed in-house. Most software is available in a wide variety of languages.

We support all our infrared cameras with a wide variety of accessories to adapt your equipment to the most demanding infrared applications.

37.2 Sharing our knowledge

Although our cameras are designed to be very user-friendly, there is a lot more to thermography than just knowing how to handle a camera. Therefore, FLIR Systems has founded the Infrared Training Center (ITC), a separate business unit, that provides certified training courses. Attending one of the ITC courses will give you a truly hands-on learning experience.

The staff of the ITC are also there to provide you with any application support you may need in putting infrared theory into practice.

37.3 Supporting our customers

FLIR Systems operates a worldwide service network to keep your camera running at all times. If you discover a problem with your camera, local service centers have all the equipment and expertise to solve it within the shortest possible time. Therefore, there is no need to send your camera to the other side of the world or to talk to someone who does not speak your language.

Term	Definition
Absorption and emission ⁴	The capacity or ability of an object to absorb incident radiated energy is always the same as the capacity to emit its own energy as radiation
Apparent temperature	uncompensated reading from an infrared instrument, containing all radiation incident on the instrument, regardless of its sources ⁵
Color palette	assigns different colors to indicate specific levels of apparent temperature. Palettes can provide high or low contrast, depending on the colors used in them
Conduction	direct transfer of thermal energy from molecule to molecule, caused by collisions between the molecules
Convection	heat transfer mode where a fluid is brought into motion, either by gravity or another force, thereby transferring heat from one place to another
Diagnostics	examination of symptoms and syndromes to determine the nature of faults or failures ⁶
Direction of heat transfer ⁷	Heat will spontaneously flow from hotter to colder, thereby transferring thermal energy from one place to another ⁸
Emissivity	ratio of the power radiated by real bodies to the power that is radiated by a blackbody at the same temperature and at the same wavelength ⁹
Energy conservation ¹⁰	The sum of the total energy contents in a closed system is constant
Exitant radiation	radiation that leaves the surface of an object, regardless of its original sources
Heat	thermal energy that is transferred between two objects (systems) due to their difference in temperature
Heat transfer rate ¹¹	The heat transfer rate under steady state conditions is directly proportional to the thermal conductivity of the object, the cross-sectional area of the object through which the heat flows, and the temperature difference between the two ends of the object. It is inversely proportional to the length, or thickness, of the object ¹²
Incident radiation	radiation that strikes an object from its surroundings
IR thermography	process of acquisition and analysis of thermal information from non-contact thermal imaging devices
Isotherm	replaces certain colors in the scale with a contrasting color. It marks an interval of equal apparent temperature ¹³
Qualitative thermography	thermography that relies on the analysis of thermal patterns to reveal the existence of and to locate the position of anomalies ¹⁴
Quantitative thermography	thermography that uses temperature measurement to determine the seriousness of an anomaly, in order to establish repair priorities ¹⁴

4. Kirchhoff's law of thermal radiation.

5. Based on ISO 18434-1:2008 (en).

6. Based on ISO 13372:2004 (en).

7. 2nd law of thermodynamics.

8. This is a consequence of the 2nd law of thermodynamics, the law itself is more complicated.

9. Based on ISO 16714-3:2016 (en).

10. 1st law of thermodynamics.

11. Fourier's law.

12. This is the one-dimensional form of Fourier's law, valid for steady-state conditions.

13. Based on ISO 18434-1:2008 (en)

14. Based on ISO 10878-2013 (en).

Term	Definition
Radiative heat transfer	Heat transfer by the emission and absorption of thermal radiation
Reflected apparent temperature	apparent temperature of the environment that is reflected by the target into the IR camera ¹⁵
Spatial resolution	ability of an IR camera to resolve small objects or details
Temperature	measure of the average kinetic energy of the molecules and atoms that make up the substance
Thermal energy	total kinetic energy of the molecules that make up the object ¹⁶
Thermal gradient	gradual change in temperature over distance ¹⁵
Thermal tuning	process of putting the colors of the image on the object of analysis, in order to maximize contrast

15. Based on ISO 16714-3:2016 (en).

16. Thermal energy is part of the internal energy of an object.

39.1 Introduction

An infrared camera measures and images the emitted infrared radiation from an object. The fact that radiation is a function of object surface temperature makes it possible for the camera to calculate and display this temperature.

However, the radiation measured by the camera does not only depend on the temperature of the object but is also a function of the emissivity. Radiation also originates from the surroundings and is reflected in the object. The radiation from the object and the reflected radiation will also be influenced by the absorption of the atmosphere.

To measure temperature accurately, it is therefore necessary to compensate for the effects of a number of different radiation sources. This is done on-line automatically by the camera. The following object parameters must, however, be supplied for the camera:

- The emissivity of the object
- The reflected apparent temperature
- The distance between the object and the camera
- The relative humidity
- Temperature of the atmosphere

39.2 Emissivity

The most important object parameter to set correctly is the emissivity which, in short, is a measure of how much radiation is emitted from the object, compared to that from a perfect blackbody of the same temperature.

Normally, object materials and surface treatments exhibit emissivity ranging from approximately 0.1 to 0.95. A highly polished (mirror) surface falls below 0.1, while an oxidized or painted surface has a higher emissivity. Oil-based paint, regardless of color in the visible spectrum, has an emissivity over 0.9 in the infrared. Human skin exhibits an emissivity 0.97 to 0.98.

Non-oxidized metals represent an extreme case of perfect opacity and high reflexivity, which does not vary greatly with wavelength. Consequently, the emissivity of metals is low – only increasing with temperature. For non-metals, emissivity tends to be high, and decreases with temperature.

39.2.1 Finding the emissivity of a sample

39.2.1.1 *Step 1: Determining reflected apparent temperature*

Use one of the following two methods to determine reflected apparent temperature:

39.2.1.1.1 Method 1: Direct method

Follow this procedure:

1. Look for possible reflection sources, considering that the incident angle = reflection angle ($a = b$).

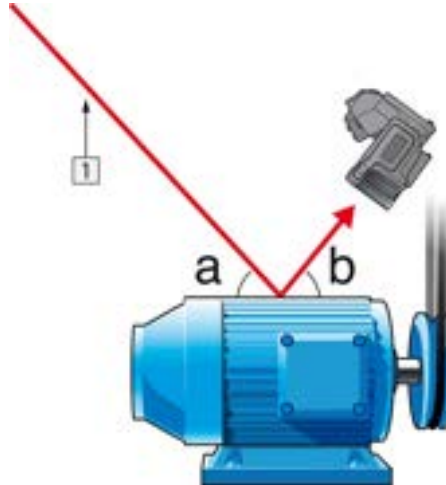

Figure 39.1 1 = Reflection source

2. If the reflection source is a spot source, modify the source by obstructing it using a piece of cardboard.

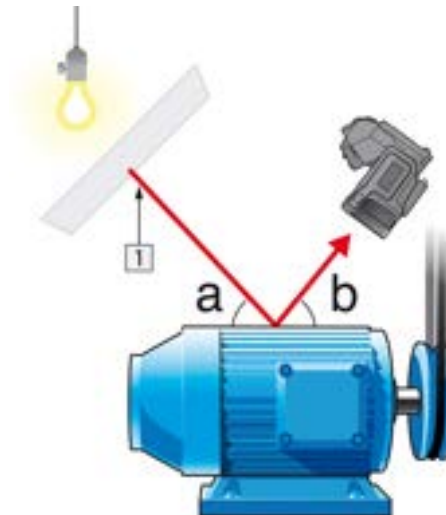

Figure 39.2 1 = Reflection source

3. Measure the radiation intensity (= apparent temperature) from the reflection source using the following settings:

- Emissivity: 1.0
- D_{obj} : 0

You can measure the radiation intensity using one of the following two methods:

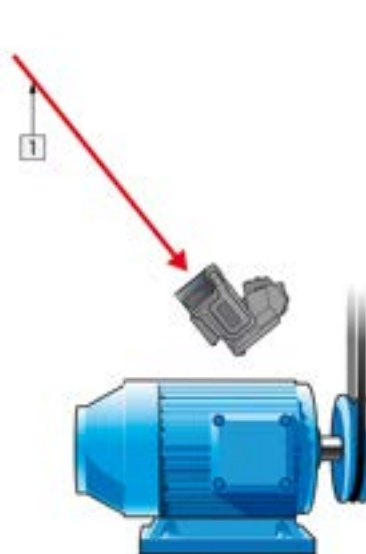

Figure 39.3 1 = Reflection source

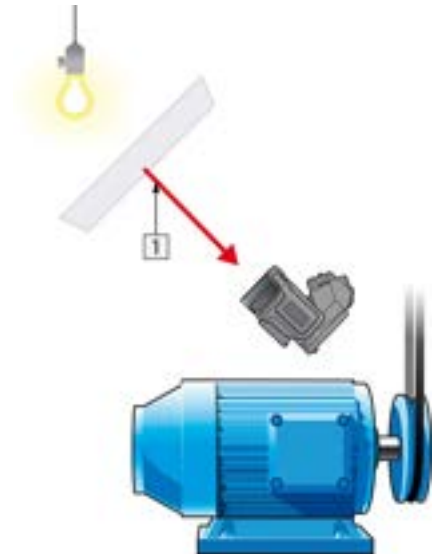

Figure 39.4 1 = Reflection source

You can not use a thermocouple to measure reflected apparent temperature, because a thermocouple measures *temperature*, but apparent temperature is *radiation intensity*.

39.2.1.1.2 Method 2: Reflector method

Follow this procedure:

1. Crumble up a large piece of aluminum foil.
2. Uncrumble the aluminum foil and attach it to a piece of cardboard of the same size.
3. Put the piece of cardboard in front of the object you want to measure. Make sure that the side with aluminum foil points to the camera.
4. Set the emissivity to 1.0.

5. Measure the apparent temperature of the aluminum foil and write it down. The foil is considered a perfect reflector, so its apparent temperature equals the reflected apparent temperature from the surroundings.

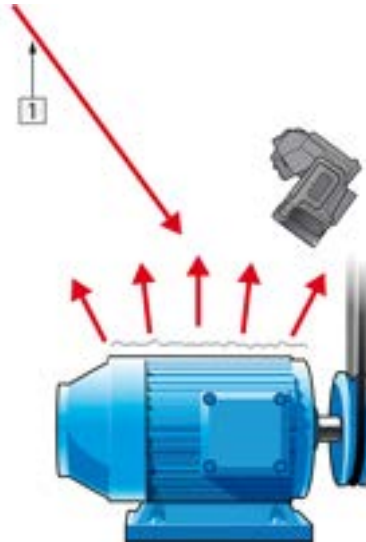

Figure 39.5 Measuring the apparent temperature of the aluminum foil.

39.2.1.2 Step 2: Determining the emissivity

Follow this procedure:

1. Select a place to put the sample.
2. Determine and set reflected apparent temperature according to the previous procedure.
3. Put a piece of electrical tape with known high emissivity on the sample.
4. Heat the sample at least 20 K above room temperature. Heating must be reasonably even.
5. Focus and auto-adjust the camera, and freeze the image.
6. Adjust *Level* and *Span* for best image brightness and contrast.
7. Set emissivity to that of the tape (usually 0.97).
8. Measure the temperature of the tape using one of the following measurement functions:
 - *Isotherm* (helps you to determine both the temperature and how evenly you have heated the sample)
 - *Spot* (simpler)
 - *Box Avg* (good for surfaces with varying emissivity).
9. Write down the temperature.
10. Move your measurement function to the sample surface.
11. Change the emissivity setting until you read the same temperature as your previous measurement.
12. Write down the emissivity.

Note

- Avoid forced convection
- Look for a thermally stable surrounding that will not generate spot reflections
- Use high quality tape that you know is not transparent, and has a high emissivity you are certain of
- This method assumes that the temperature of your tape and the sample surface are the same. If they are not, your emissivity measurement will be wrong.

39.3 Reflected apparent temperature

This parameter is used to compensate for the radiation reflected in the object. If the emissivity is low and the object temperature relatively far from that of the reflected it will be important to set and compensate for the reflected apparent temperature correctly.

39.4 Distance

The distance is the distance between the object and the front lens of the camera. This parameter is used to compensate for the following two facts:

- That radiation from the target is absorbed by the atmosphere between the object and the camera.
- That radiation from the atmosphere itself is detected by the camera.

39.5 Relative humidity

The camera can also compensate for the fact that the transmittance is also dependent on the relative humidity of the atmosphere. To do this set the relative humidity to the correct value. For short distances and normal humidity the relative humidity can normally be left at a default value of 50%.

39.6 Other parameters

In addition, some cameras and analysis programs from FLIR Systems allow you to compensate for the following parameters:

- Atmospheric temperature – *i.e.* the temperature of the atmosphere between the camera and the target
- External optics temperature – *i.e.* the temperature of any external lenses or windows used in front of the camera
- External optics transmittance – *i.e.* the transmission of any external lenses or windows used in front of the camera

40.1 Introduction

Calibration of a thermal camera is a prerequisite for temperature measurement. The calibration provides the relationship between the input signal and the physical quantity that the user wants to measure. However, despite its widespread and frequent use, the term “calibration” is often misunderstood and misused. Local and national differences as well as translation-related issues create additional confusion.

Unclear terminology can lead to difficulties in communication and erroneous translations, and subsequently to incorrect measurements due to misunderstandings and, in the worst case, even to lawsuits.

40.2 Definition—what is calibration?

The International Bureau of Weights and Measures¹⁷ defines *calibration*¹⁸ in the following way:

an operation that, under specified conditions, in a first step, establishes a relation between the quantity values with measurement uncertainties provided by measurement standards and corresponding indications with associated measurement uncertainties and, in a second step, uses this information to establish a relation for obtaining a measurement result from an indication.

The calibration itself may be expressed in different formats: this can be a statement, calibration function, calibration diagram¹⁹, calibration curve²⁰, or calibration table.

Often, the first step alone in the above definition is perceived and referred to as being “calibration.” However, this is not (always) sufficient.

Considering the calibration procedure of a thermal camera, the first step establishes the relation between emitted radiation (the quantity value) and the electrical output signal (the indication). This first step of the calibration procedure consists of obtaining a homogeneous (or uniform) response when the camera is placed in front of an extended source of radiation.

As we know the temperature of the reference source emitting the radiation, in the second step the obtained output signal (the indication) can be related to the reference source’s temperature (measurement result). The second step includes drift measurement and compensation.

To be correct, calibration of a thermal camera is, strictly, not expressed through temperature. Thermal cameras are sensitive to infrared radiation: therefore, at first you obtain a radiance correspondence, then a relationship between radiance and temperature. For bolometer cameras used by non-R&D customers, radiance is not expressed: only the temperature is provided.

40.3 Camera calibration at FLIR Systems

Without calibration, an infrared camera would not be able to measure either radiance or temperature. At FLIR Systems, the calibration of uncooled microbolometer cameras with a measurement capability is carried out during both production and service. Cooled cameras with photon detectors are often calibrated by the user with special software. With this type of software, in theory, common handheld uncooled thermal cameras could be calibrated by the user too. However, as this software is not suitable for reporting

17. <http://www.bipm.org/en/about-us/> [Retrieved 2017-01-31.]

18. <http://jcg.m.bipm.org/vim/en/2.39.html> [Retrieved 2017-01-31.]

19. <http://jcg.m.bipm.org/vim/en/4.30.html> [Retrieved 2017-01-31.]

20. <http://jcg.m.bipm.org/vim/en/4.31.html> [Retrieved 2017-01-31.]

purposes, most users do not have it. Non-measuring devices that are used for imaging only do not need temperature calibration. Sometimes this is also reflected in camera terminology when talking about infrared or thermal imaging cameras compared with thermography cameras, where the latter are the measuring devices.

The calibration information, no matter if the calibration is done by FLIR Systems or the user, is stored in calibration curves, which are expressed by mathematical functions. As radiation intensity changes with both temperature and the distance between the object and the camera, different curves are generated for different temperature ranges and exchangeable lenses.

40.4 The differences between a calibration performed by a user and that performed directly at FLIR Systems

First, the reference sources that FLIR Systems uses are themselves calibrated and traceable. This means, at each FLIR Systems site performing calibration, that the sources are controlled by an independent national authority. The camera calibration certificate is confirmation of this. It is proof that not only has the calibration been performed by FLIR Systems but that it has also been carried out using calibrated references. Some users own or have access to accredited reference sources, but they are very few in number.

Second, there is a technical difference. When performing a user calibration, the result is often (but not always) not drift compensated. This means that the values do not take into account a possible change in the camera's output when the camera's internal temperature varies. This yields a larger uncertainty. Drift compensation uses data obtained in climate-controlled chambers. All FLIR Systems cameras are drift compensated when they are first delivered to the customer and when they are recalibrated by FLIR Systems service departments.

40.5 Calibration, verification and adjustment

A common misconception is to confuse *calibration* with *verification* or *adjustment*. Indeed, calibration is a prerequisite for *verification*, which provides confirmation that specified requirements are met. Verification provides objective evidence that a given item fulfills specified requirements. To obtain the verification, defined temperatures (emitted radiation) of calibrated and traceable reference sources are measured. The measurement results, including the deviation, are noted in a table. The verification certificate states that these measurement results meet specified requirements. Sometimes, companies or organizations offer and market this verification certificate as a "calibration certificate."

Proper verification—and by extension calibration and/or recalibration—can only be achieved when a validated protocol is respected. The process is more than placing the camera in front of blackbodies and checking if the camera output (as temperature, for instance) corresponds to the original calibration table. It is often forgotten that a camera is not sensitive to temperature but to radiation. Furthermore, a camera is an *imaging* system, not just a single sensor. Consequently, if the optical configuration allowing the camera to "collect" radiance is poor or misaligned, then the "verification" (or calibration or recalibration) is worthless.

For instance, one has to ensure that the distance between the blackbody and the camera as well as the diameter of the blackbody cavity are chosen so as to reduce stray radiation and the size-of-source effect.

To summarize: a validated protocol must comply with the physical laws for *radiance*, and not only those for temperature.

Calibration is also a prerequisite for *adjustment*, which is the set of operations carried out on a measuring system such that the system provides prescribed indications corresponding to given values of quantities to be measured, typically obtained from measurement standards. Simplified, adjustment is a manipulation that results in instruments that measure correctly within their specifications. In everyday language, the term “calibration” is widely used instead of “adjustment” for measuring devices.

40.6 Non-uniformity correction

When the thermal camera displays “Calibrating...” it is adjusting for the deviation in response of each individual detector element (pixel). In thermography, this is called a “non-uniformity correction” (NUC). It is an offset update, and the gain remains unchanged.

The European standard EN 16714-3, Non-destructive Testing—Thermographic Testing—Part 3: Terms and Definitions, defines an NUC as “Image correction carried out by the camera software to compensate for different sensitivities of detector elements and other optical and geometrical disturbances.”

During the NUC (the offset update), a shutter (internal flag) is placed in the optical path, and all the detector elements are exposed to the same amount of radiation originating from the shutter. Therefore, in an ideal situation, they should all give the same output signal. However, each individual element has its own response, so the output is not uniform. This deviation from the ideal result is calculated and used to mathematically perform an image correction, which is essentially a correction of the displayed radiation signal. Some cameras do not have an internal flag. In this case, the offset update must be performed manually using special software and an external uniform source of radiation.

An NUC is performed, for example, at start-up, when changing a measurement range, or when the environment temperature changes. Some cameras also allow the user to trigger it manually. This is useful when you have to perform a critical measurement with as little image disturbance as possible.

40.7 Thermal image adjustment (thermal tuning)

Some people use the term “image calibration” when adjusting the thermal contrast and brightness in the image to enhance specific details. During this operation, the temperature interval is set in such a way that all available colors are used to show only (or mainly) the temperatures in the region of interest. The correct term for this manipulation is “thermal image adjustment” or “thermal tuning”, or, in some languages, “thermal image optimization.” You must be in manual mode to undertake this, otherwise the camera will set the lower and upper limits of the displayed temperature interval automatically to the coldest and hottest temperatures in the scene.

Before the year 1800, the existence of the infrared portion of the electromagnetic spectrum wasn't even suspected. The original significance of the infrared spectrum, or simply 'the infrared' as it is often called, as a form of heat radiation is perhaps less obvious today than it was at the time of its discovery by Herschel in 1800.



Figure 41.1 Sir William Herschel (1738–1822)

The discovery was made accidentally during the search for a new optical material. Sir William Herschel – Royal Astronomer to King George III of England, and already famous for his discovery of the planet Uranus – was searching for an optical filter material to reduce the brightness of the sun's image in telescopes during solar observations. While testing different samples of colored glass which gave similar reductions in brightness he was intrigued to find that some of the samples passed very little of the sun's heat, while others passed so much heat that he risked eye damage after only a few seconds' observation.

Herschel was soon convinced of the necessity of setting up a systematic experiment, with the objective of finding a single material that would give the desired reduction in brightness as well as the maximum reduction in heat. He began the experiment by actually repeating Newton's prism experiment, but looking for the heating effect rather than the visual distribution of intensity in the spectrum. He first blackened the bulb of a sensitive mercury-in-glass thermometer with ink, and with this as his radiation detector he proceeded to test the heating effect of the various colors of the spectrum formed on the top of a table by passing sunlight through a glass prism. Other thermometers, placed outside the sun's rays, served as controls.

As the blackened thermometer was moved slowly along the colors of the spectrum, the temperature readings showed a steady increase from the violet end to the red end. This was not entirely unexpected, since the Italian researcher, Landriani, in a similar experiment in 1777 had observed much the same effect. It was Herschel, however, who was the first to recognize that there must be a point where the heating effect reaches a maximum, and that measurements confined to the visible portion of the spectrum failed to locate this point.



Figure 41.2 Marsilio Landriani (1746–1815)

Moving the thermometer into the dark region beyond the red end of the spectrum, Herschel confirmed that the heating continued to increase. The maximum point, when he found it, lay well beyond the red end – in what is known today as the 'infrared wavelengths'.

When Herschel revealed his discovery, he referred to this new portion of the electromagnetic spectrum as the 'thermometrical spectrum'. The radiation itself he sometimes referred to as 'dark heat', or simply 'the invisible rays'. Ironically, and contrary to popular opinion, it wasn't Herschel who originated the term 'infrared'. The word only began to appear in print around 75 years later, and it is still unclear who should receive credit as the originator.

Herschel's use of glass in the prism of his original experiment led to some early controversies with his contemporaries about the actual existence of the infrared wavelengths. Different investigators, in attempting to confirm his work, used various types of glass indiscriminately, having different transparencies in the infrared. Through his later experiments, Herschel was aware of the limited transparency of glass to the newly-discovered thermal radiation, and he was forced to conclude that optics for the infrared would probably be doomed to the use of reflective elements exclusively (i.e. plane and curved mirrors). Fortunately, this proved to be true only until 1830, when the Italian investigator, Melloni, made his great discovery that naturally occurring rock salt (NaCl) – which was available in large enough natural crystals to be made into lenses and prisms – is remarkably transparent to the infrared. The result was that rock salt became the principal infrared optical material, and remained so for the next hundred years, until the art of synthetic crystal growing was mastered in the 1930's.



Figure 41.3 Macedonio Melloni (1798–1854)

Thermometers, as radiation detectors, remained unchallenged until 1829, the year Nobili invented the thermocouple. (Herschel's own thermometer could be read to $0.2\text{ }^{\circ}\text{C}$ ($0.036\text{ }^{\circ}\text{F}$), and later models were able to be read to $0.05\text{ }^{\circ}\text{C}$ ($0.09\text{ }^{\circ}\text{F}$)). Then a breakthrough occurred; Melloni connected a number of thermocouples in series to form the first thermopile. The new device was at least 40 times as sensitive as the best thermometer of the day for detecting heat radiation – capable of detecting the heat from a person standing three meters away.

The first so-called 'heat-picture' became possible in 1840, the result of work by Sir John Herschel, son of the discoverer of the infrared and a famous astronomer in his own right. Based upon the differential evaporation of a thin film of oil when exposed to a heat pattern focused upon it, the thermal image could be seen by reflected light where the interference effects of the oil film made the image visible to the eye. Sir John also managed to obtain a primitive record of the thermal image on paper, which he called a 'thermograph'.



Figure 41.4 Samuel P. Langley (1834–1906)

The improvement of infrared-detector sensitivity progressed slowly. Another major breakthrough, made by Langley in 1880, was the invention of the bolometer. This consisted of a thin blackened strip of platinum connected in one arm of a Wheatstone bridge circuit upon which the infrared radiation was focused and to which a sensitive galvanometer responded. This instrument is said to have been able to detect the heat from a cow at a distance of 400 meters.

An English scientist, Sir James Dewar, first introduced the use of liquefied gases as cooling agents (such as liquid nitrogen with a temperature of -196°C (-320.8°F)) in low temperature research. In 1892 he invented a unique vacuum insulating container in which it is possible to store liquefied gases for entire days. The common 'thermos bottle', used for storing hot and cold drinks, is based upon his invention.

Between the years 1900 and 1920, the inventors of the world 'discovered' the infrared. Many patents were issued for devices to detect personnel, artillery, aircraft, ships – and even icebergs. The first operating systems, in the modern sense, began to be developed during the 1914–18 war, when both sides had research programs devoted to the military exploitation of the infrared. These programs included experimental systems for enemy intrusion/detection, remote temperature sensing, secure communications, and 'flying torpedo' guidance. An infrared search system tested during this period was able to detect an approaching airplane at a distance of 1.5 km (0.94 miles), or a person more than 300 meters (984 ft.) away.

The most sensitive systems up to this time were all based upon variations of the bolometer idea, but the period between the two wars saw the development of two revolutionary new infrared detectors: the image converter and the photon detector. At first, the image converter received the greatest attention by the military, because it enabled an observer for the first time in history to literally 'see in the dark'. However, the sensitivity of the image converter was limited to the near infrared wavelengths, and the most interesting military targets (i.e. enemy soldiers) had to be illuminated by infrared search beams. Since this involved the risk of giving away the observer's position to a similarly-equipped enemy observer, it is understandable that military interest in the image converter eventually faded.

The tactical military disadvantages of so-called 'active' (i.e. search beam-equipped) thermal imaging systems provided impetus following the 1939–45 war for extensive secret military infrared-research programs into the possibilities of developing 'passive' (no search beam) systems around the extremely sensitive photon detector. During this period, military secrecy regulations completely prevented disclosure of the status of infrared-imaging technology. This secrecy only began to be lifted in the middle of the 1950's, and from that time adequate thermal-imaging devices finally began to be available to civilian science and industry.

42.1 Introduction

The subjects of infrared radiation and the related technique of thermography are still new to many who will use an infrared camera. In this section the theory behind thermography will be given.

42.2 The electromagnetic spectrum

The electromagnetic spectrum is divided arbitrarily into a number of wavelength regions, called *bands*, distinguished by the methods used to produce and detect the radiation. There is no fundamental difference between radiation in the different bands of the electromagnetic spectrum. They are all governed by the same laws and the only differences are those due to differences in wavelength.

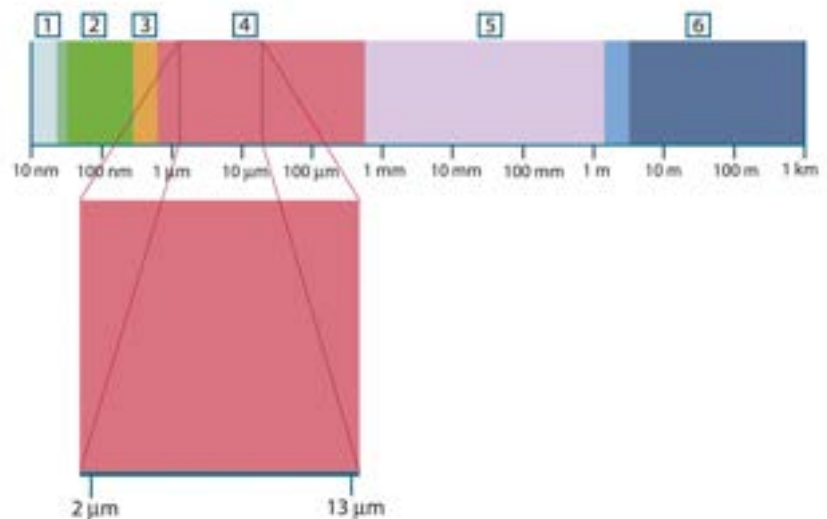

Figure 42.1 The electromagnetic spectrum. 1: X-ray; 2: UV; 3: Visible; 4: IR; 5: Microwaves; 6: Radiowaves.

Thermography makes use of the infrared spectral band. At the short-wavelength end the boundary lies at the limit of visual perception, in the deep red. At the long-wavelength end it merges with the microwave radio wavelengths, in the millimeter range.

The infrared band is often further subdivided into four smaller bands, the boundaries of which are also arbitrarily chosen. They include: the *near infrared* (0.75–3 μm), the *middle infrared* (3–6 μm), the *far infrared* (6–15 μm) and the *extreme infrared* (15–100 μm). Although the wavelengths are given in μm (micrometers), other units are often still used to measure wavelength in this spectral region, e.g. nanometer (nm) and Ångström (Å).

The relationships between the different wavelength measurements is:

$$10\,000\ \text{Å} = 1\,000\ \text{nm} = 1\ \mu = 1\ \mu\text{m}$$

42.3 Blackbody radiation

A blackbody is defined as an object which absorbs all radiation that impinges on it at any wavelength. The apparent misnomer *black* relating to an object emitting radiation is explained by Kirchhoff's Law (after *Gustav Robert Kirchhoff*, 1824–1887), which states that a body capable of absorbing all radiation at any wavelength is equally capable in the emission of radiation.



Figure 42.2 Gustav Robert Kirchhoff (1824–1887)

The construction of a blackbody source is, in principle, very simple. The radiation characteristics of an aperture in an isotherm cavity made of an opaque absorbing material represents almost exactly the properties of a blackbody. A practical application of the principle to the construction of a perfect absorber of radiation consists of a box that is light tight except for an aperture in one of the sides. Any radiation which then enters the hole is scattered and absorbed by repeated reflections so only an infinitesimal fraction can possibly escape. The blackness which is obtained at the aperture is nearly equal to a blackbody and almost perfect for all wavelengths.

By providing such an isothermal cavity with a suitable heater it becomes what is termed a *cavity radiator*. An isothermal cavity heated to a uniform temperature generates blackbody radiation, the characteristics of which are determined solely by the temperature of the cavity. Such cavity radiators are commonly used as sources of radiation in temperature reference standards in the laboratory for calibrating thermographic instruments, such as a FLIR Systems camera for example.

If the temperature of blackbody radiation increases to more than 525°C (977°F), the source begins to be visible so that it appears to the eye no longer black. This is the incipient red heat temperature of the radiator, which then becomes orange or yellow as the temperature increases further. In fact, the definition of the so-called *color temperature* of an object is the temperature to which a blackbody would have to be heated to have the same appearance.

Now consider three expressions that describe the radiation emitted from a blackbody.

42.3.1 Planck's law



Figure 42.3 Max Planck (1858–1947)

Max Planck (1858–1947) was able to describe the spectral distribution of the radiation from a blackbody by means of the following formula:

$$W_{\lambda} = \frac{2\pi hc^2}{\lambda^5 \left(e^{\frac{hc}{\lambda kT}} - 1 \right)} \times 10^{-6} [\text{Watt} / \text{m}^2, \mu\text{m}]$$

where:

$W_{\lambda b}$	Blackbody spectral radiant emittance at wavelength λ .
c	Velocity of light = 3×10^8 m/s
h	Planck's constant = 6.6×10^{-34} Joule sec.
k	Boltzmann's constant = 1.4×10^{-23} Joule/K.
T	Absolute temperature (K) of a blackbody.
λ	Wavelength (μm).

Note The factor 10^{-6} is used since spectral emittance in the curves is expressed in $\text{Watt/m}^2, \mu\text{m}$.

Planck's formula, when plotted graphically for various temperatures, produces a family of curves. Following any particular Planck curve, the spectral emittance is zero at $\lambda = 0$, then increases rapidly to a maximum at a wavelength λ_{max} and after passing it approaches zero again at very long wavelengths. The higher the temperature, the shorter the wavelength at which maximum occurs.

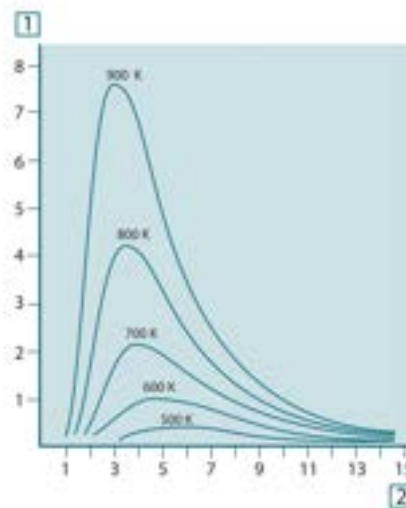

Figure 42.4 Blackbody spectral radiant emittance according to Planck's law, plotted for various absolute temperatures. 1: Spectral radiant emittance ($\text{W}/\text{cm}^2 \times 10^3(\mu\text{m})$); 2: Wavelength (μm)

42.3.2 Wien's displacement law

By differentiating Planck's formula with respect to λ , and finding the maximum, we have:

$$\lambda_{\text{max}} = \frac{2898}{T} [\mu\text{m}]$$

This is Wien's formula (after *Wilhelm Wien*, 1864–1928), which expresses mathematically the common observation that colors vary from red to orange or yellow as the temperature of a thermal radiator increases. The wavelength of the color is the same as the wavelength calculated for λ_{max} . A good approximation of the value of λ_{max} for a given blackbody temperature is obtained by applying the rule-of-thumb $3\,000/T \mu\text{m}$. Thus, a very hot star such as Sirius (11 000 K), emitting bluish-white light, radiates with the peak of spectral radiant emittance occurring within the invisible ultraviolet spectrum, at wavelength $0.27 \mu\text{m}$.



Figure 42.5 Wilhelm Wien (1864–1928)

The sun (approx. 6 000 K) emits yellow light, peaking at about 0.5 μm in the middle of the visible light spectrum.

At room temperature (300 K) the peak of radiant emittance lies at 9.7 μm , in the far infrared, while at the temperature of liquid nitrogen (77 K) the maximum of the almost insignificant amount of radiant emittance occurs at 38 μm , in the extreme infrared wavelengths.

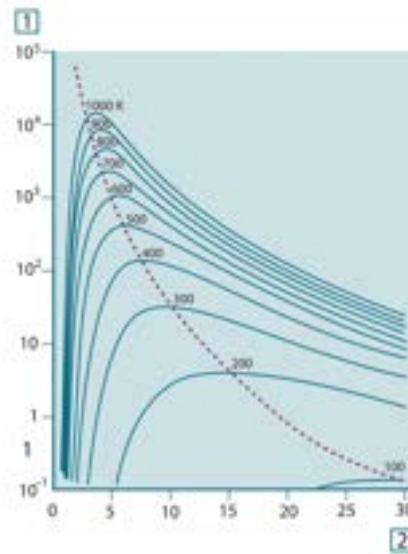

Figure 42.6 Planckian curves plotted on semi-log scales from 100 K to 1000 K. The dotted line represents the locus of maximum radiant emittance at each temperature as described by Wien's displacement law. 1: Spectral radiant emittance ($\text{W/cm}^2 (\mu\text{m})$); 2: Wavelength (μm).

42.3.3 Stefan-Boltzmann's law

By integrating Planck's formula from $\lambda = 0$ to $\lambda = \infty$, we obtain the total radiant emittance (W_b) of a blackbody:

$$W_b = \sigma T^4 \quad [\text{Watt/m}^2]$$

This is the Stefan-Boltzmann formula (after *Josef Stefan*, 1835–1893, and *Ludwig Boltzmann*, 1844–1906), which states that the total emissive power of a blackbody is proportional to the fourth power of its absolute temperature. Graphically, W_b represents the area below the Planck curve for a particular temperature. It can be shown that the radiant emittance in the interval $\lambda = 0$ to λ_{max} is only 25% of the total, which represents about the amount of the sun's radiation which lies inside the visible light spectrum.



Figure 42.7 Josef Stefan (1835–1893), and Ludwig Boltzmann (1844–1906)

Using the Stefan-Boltzmann formula to calculate the power radiated by the human body, at a temperature of 300 K and an external surface area of approx. 2 m², we obtain 1 kW. This power loss could not be sustained if it were not for the compensating absorption of radiation from surrounding surfaces, at room temperatures which do not vary too drastically from the temperature of the body – or, of course, the addition of clothing.

42.3.4 Non-blackbody emitters

So far, only blackbody radiators and blackbody radiation have been discussed. However, real objects almost never comply with these laws over an extended wavelength region – although they may approach the blackbody behavior in certain spectral intervals. For example, a certain type of white paint may appear perfectly *white* in the visible light spectrum, but becomes distinctly *gray* at about 2 μm, and beyond 3 μm it is almost *black*.

There are three processes which can occur that prevent a real object from acting like a blackbody: a fraction of the incident radiation α may be absorbed, a fraction ρ may be reflected, and a fraction τ may be transmitted. Since all of these factors are more or less wavelength dependent, the subscript λ is used to imply the spectral dependence of their definitions. Thus:

- The spectral absorptance α_λ = the ratio of the spectral radiant power absorbed by an object to that incident upon it.
- The spectral reflectance ρ_λ = the ratio of the spectral radiant power reflected by an object to that incident upon it.
- The spectral transmittance τ_λ = the ratio of the spectral radiant power transmitted through an object to that incident upon it.

The sum of these three factors must always add up to the whole at any wavelength, so we have the relation:

$$\alpha_\lambda + \rho_\lambda + \tau_\lambda = 1$$

For opaque materials $\tau_\lambda = 0$ and the relation simplifies to:

$$\alpha_\lambda + \rho_\lambda = 1$$

Another factor, called the emissivity, is required to describe the fraction ε of the radiant emittance of a blackbody produced by an object at a specific temperature. Thus, we have the definition:

The spectral emissivity ε_λ = the ratio of the spectral radiant power from an object to that from a blackbody at the same temperature and wavelength.

Expressed mathematically, this can be written as the ratio of the spectral emittance of the object to that of a blackbody as follows:

$$\varepsilon_\lambda = \frac{W_\lambda}{W_{\lambda,b}}$$

Generally speaking, there are three types of radiation source, distinguished by the ways in which the spectral emittance of each varies with wavelength.

- A blackbody, for which $\varepsilon_\lambda = \varepsilon = 1$
- A graybody, for which $\varepsilon_\lambda = \varepsilon = \text{constant less than 1}$

- A selective radiator, for which ϵ varies with wavelength

According to Kirchhoff's law, for any material the spectral emissivity and spectral absorptance of a body are equal at any specified temperature and wavelength. That is:

$$\epsilon_\lambda = \alpha_\lambda$$

From this we obtain, for an opaque material (since $\alpha_\lambda + \rho_\lambda = 1$):

$$\epsilon_\lambda + \rho_\lambda = 1$$

For highly polished materials ϵ_λ approaches zero, so that for a perfectly reflecting material (*i.e.* a perfect mirror) we have:

$$\rho_\lambda = 1$$

For a graybody radiator, the Stefan-Boltzmann formula becomes:

$$W = \epsilon \sigma T^4 \text{ [Watt/m}^2\text{]}$$

This states that the total emissive power of a graybody is the same as a blackbody at the same temperature reduced in proportion to the value of ϵ from the graybody.

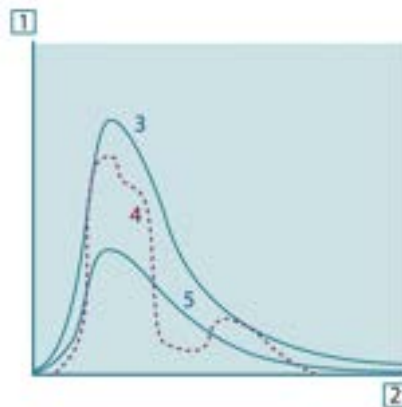

Figure 42.8 Spectral radiant emittance of three types of radiators. 1: Spectral radiant emittance; 2: Wavelength; 3: Blackbody; 4: Selective radiator; 5: Graybody.

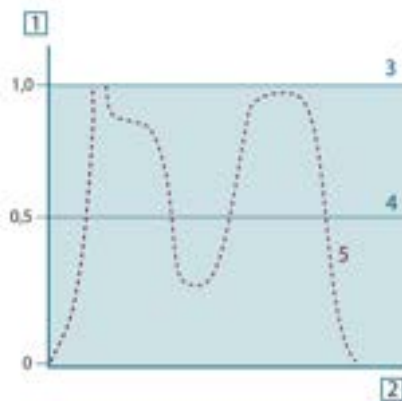

Figure 42.9 Spectral emissivity of three types of radiators. 1: Spectral emissivity; 2: Wavelength; 3: Blackbody; 4: Graybody; 5: Selective radiator.

42.4 Infrared semi-transparent materials

Consider now a non-metallic, semi-transparent body – let us say, in the form of a thick flat plate of plastic material. When the plate is heated, radiation generated within its volume must work its way toward the surfaces through the material in which it is partially absorbed. Moreover, when it arrives at the surface, some of it is reflected back into the interior. The back-reflected radiation is again partially absorbed, but some of it arrives at the other surface, through which most of it escapes; part of it is reflected back again. Although the progressive reflections become weaker and weaker they must all be added up when the total emittance of the plate is sought. When the resulting geometrical series is summed, the effective emissivity of a semi-transparent plate is obtained as:

$$\varepsilon_{\lambda} = \frac{(1 - \rho_{\lambda})(1 - \tau_{\lambda})}{1 - \rho_{\lambda}\tau_{\lambda}}$$

When the plate becomes opaque this formula is reduced to the single formula:

$$\varepsilon_{\lambda} = 1 - \rho_{\lambda}$$

This last relation is a particularly convenient one, because it is often easier to measure reflectance than to measure emissivity directly.

As already mentioned, when viewing an object, the camera receives radiation not only from the object itself. It also collects radiation from the surroundings reflected via the object surface. Both these radiation contributions become attenuated to some extent by the atmosphere in the measurement path. To this comes a third radiation contribution from the atmosphere itself.

This description of the measurement situation, as illustrated in the figure below, is so far a fairly true description of the real conditions. What has been neglected could for instance be sun light scattering in the atmosphere or stray radiation from intense radiation sources outside the field of view. Such disturbances are difficult to quantify, however, in most cases they are fortunately small enough to be neglected. In case they are not negligible, the measurement configuration is likely to be such that the risk for disturbance is obvious, at least to a trained operator. It is then his responsibility to modify the measurement situation to avoid the disturbance e.g. by changing the viewing direction, shielding off intense radiation sources etc.

Accepting the description above, we can use the figure below to derive a formula for the calculation of the object temperature from the calibrated camera output.

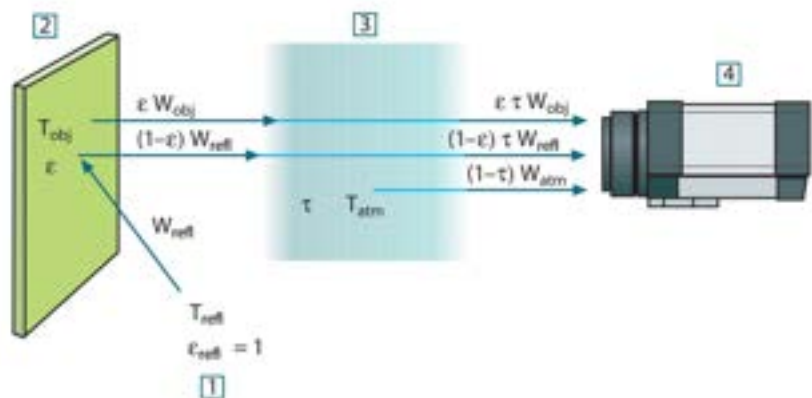

Figure 43.1 A schematic representation of the general thermographic measurement situation. 1: Surroundings; 2: Object; 3: Atmosphere; 4: Camera

Assume that the received radiation power W from a blackbody source of temperature T_{source} on short distance generates a camera output signal U_{source} that is proportional to the power input (power linear camera). We can then write (Equation 1):

$$U_{\text{source}} = CW(T_{\text{source}})$$

or, with simplified notation:

$$U_{\text{source}} = CW_{\text{source}}$$

where C is a constant.

Should the source be a graybody with emittance ϵ , the received radiation would consequently be $\epsilon W_{\text{source}}$.

We are now ready to write the three collected radiation power terms:

1. *Emission from the object* = $\epsilon\tau W_{\text{obj}}$, where ϵ is the emittance of the object and τ is the transmittance of the atmosphere. The object temperature is T_{obj} .

2. *Reflected emission from ambient sources* = $(1 - \varepsilon)\tau W_{\text{refl}}$, where $(1 - \varepsilon)$ is the reflectance of the object. The ambient sources have the temperature T_{refl} .

It has here been assumed that the temperature T_{refl} is the same for all emitting surfaces within the halfsphere seen from a point on the object surface. This is of course sometimes a simplification of the true situation. It is, however, a necessary simplification in order to derive a workable formula, and T_{refl} can – at least theoretically – be given a value that represents an efficient temperature of a complex surrounding.

Note also that we have assumed that the emittance for the surroundings = 1. This is correct in accordance with Kirchhoff's law: All radiation impinging on the surrounding surfaces will eventually be absorbed by the same surfaces. Thus the emittance = 1. (Note though that the latest discussion requires the complete sphere around the object to be considered.)

3. *Emission from the atmosphere* = $(1 - \tau)W_{\text{atm}}$, where $(1 - \tau)$ is the emittance of the atmosphere. The temperature of the atmosphere is T_{atm} .

The total received radiation power can now be written (Equation 2):

$$W_{\text{tot}} = \varepsilon\tau W_{\text{obj}} + (1 - \varepsilon)\tau W_{\text{refl}} + (1 - \tau)W_{\text{atm}}$$

We multiply each term by the constant C of Equation 1 and replace the CW products by the corresponding U according to the same equation, and get (Equation 3):

$$U_{\text{tot}} = \varepsilon\tau U_{\text{obj}} + (1 - \varepsilon)\tau U_{\text{refl}} + (1 - \tau)U_{\text{atm}}$$

Solve Equation 3 for U_{obj} (Equation 4):

$$U_{\text{obj}} = \frac{1}{\varepsilon\tau} U_{\text{tot}} - \frac{1 - \varepsilon}{\varepsilon} U_{\text{refl}} - \frac{1 - \tau}{\varepsilon\tau} U_{\text{atm}}$$

This is the general measurement formula used in all the FLIR Systems thermographic equipment. The variables of the formula are:

Table 43.1 Voltages

U_{obj}	Calculated camera output voltage for a blackbody of temperature T_{obj} i.e. a voltage that can be directly converted into true requested object temperature.
U_{tot}	Measured camera output voltage for the actual case.
U_{refl}	Theoretical camera output voltage for a blackbody of temperature T_{refl} according to the calibration.
U_{atm}	Theoretical camera output voltage for a blackbody of temperature T_{atm} according to the calibration.

The operator has to supply a number of parameter values for the calculation:

- the object emittance ε ,
- the relative humidity,
- T_{atm}
- object distance (D_{obj})
- the (effective) temperature of the object surroundings, or the reflected ambient temperature T_{refl} , and
- the temperature of the atmosphere T_{atm}

This task could sometimes be a heavy burden for the operator since there are normally no easy ways to find accurate values of emittance and atmospheric transmittance for the actual case. The two temperatures are normally less of a problem provided the surroundings do not contain large and intense radiation sources.

A natural question in this connection is: How important is it to know the right values of these parameters? It could though be of interest to get a feeling for this problem already here by looking into some different measurement cases and compare the relative

magnitudes of the three radiation terms. This will give indications about when it is important to use correct values of which parameters.

The figures below illustrates the relative magnitudes of the three radiation contributions for three different object temperatures, two emittances, and two spectral ranges: SW and LW. Remaining parameters have the following fixed values:

- $\tau = 0.88$
- $T_{\text{refl}} = +20^{\circ}\text{C}$ ($+68^{\circ}\text{F}$)
- $T_{\text{atm}} = +20^{\circ}\text{C}$ ($+68^{\circ}\text{F}$)

It is obvious that measurement of low object temperatures are more critical than measuring high temperatures since the 'disturbing' radiation sources are relatively much stronger in the first case. Should also the object emittance be low, the situation would be still more difficult.

We have finally to answer a question about the importance of being allowed to use the calibration curve above the highest calibration point, what we call extrapolation. Imagine that we in a certain case measure $U_{\text{tot}} = 4.5$ volts. The highest calibration point for the camera was in the order of 4.1 volts, a value unknown to the operator. Thus, even if the object happened to be a blackbody, i.e. $U_{\text{obj}} = U_{\text{tot}}$, we are actually performing extrapolation of the calibration curve when converting 4.5 volts into temperature.

Let us now assume that the object is not black, it has an emittance of 0.75, and the transmittance is 0.92. We also assume that the two second terms of Equation 4 amount to 0.5 volts together. Computation of U_{obj} by means of Equation 4 then results in $U_{\text{obj}} = 4.5 / 0.75 / 0.92 - 0.5 = 6.0$. This is a rather extreme extrapolation, particularly when considering that the video amplifier might limit the output to 5 volts! Note, though, that the application of the calibration curve is a theoretical procedure where no electronic or other limitations exist. We trust that if there had been no signal limitations in the camera, and if it had been calibrated far beyond 5 volts, the resulting curve would have been very much the same as our real curve extrapolated beyond 4.1 volts, provided the calibration algorithm is based on radiation physics, like the FLIR Systems algorithm. Of course there must be a limit to such extrapolations.

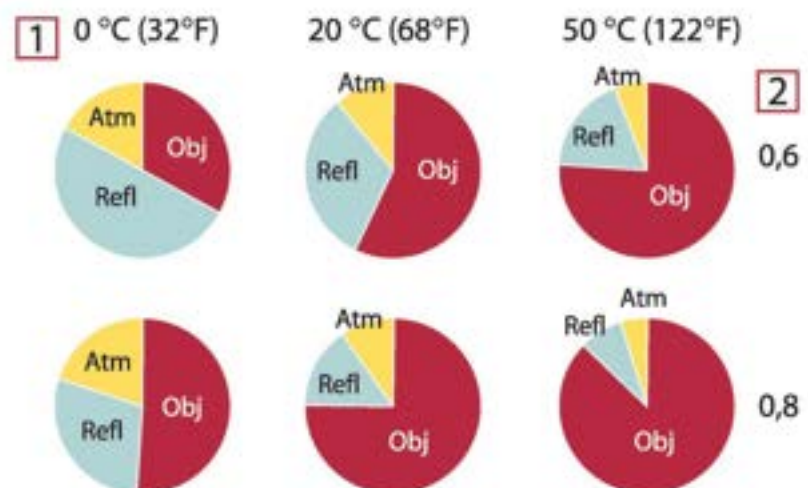

Figure 43.2 Relative magnitudes of radiation sources under varying measurement conditions (SW camera). 1: Object temperature; 2: Emittance; Obj: Object radiation; Refl: Reflected radiation; Atm: atmosphere radiation. Fixed parameters: $\tau = 0.88$; $T_{\text{refl}} = 20^{\circ}\text{C}$ ($+68^{\circ}\text{F}$); $T_{\text{atm}} = 20^{\circ}\text{C}$ ($+68^{\circ}\text{F}$).

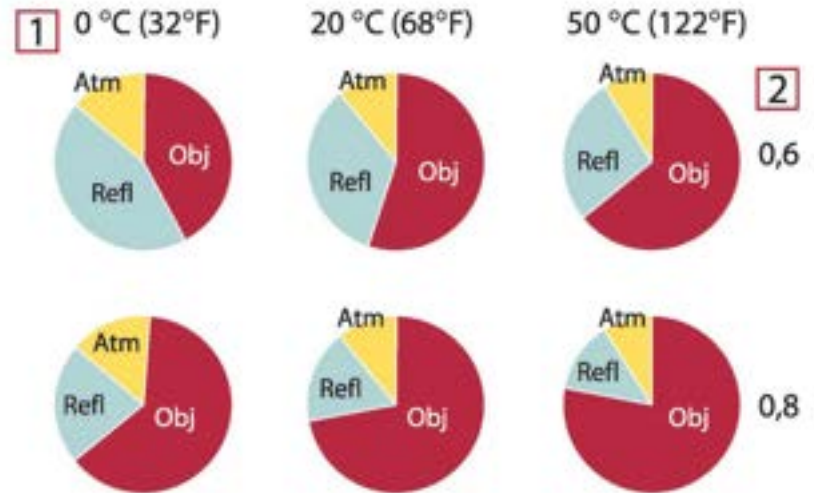

Figure 43.3 Relative magnitudes of radiation sources under varying measurement conditions (LW camera). 1: Object temperature; 2: Emittance; Obj: Object radiation; Refl: Reflected radiation; Atm: atmosphere radiation. Fixed parameters: $\tau = 0.88$; $T_{\text{refl}} = 20^{\circ}\text{C}$ (+68°F); $T_{\text{atm}} = 20^{\circ}\text{C}$ (+68°F).

This section presents a compilation of emissivity data from the infrared literature and measurements made by FLIR Systems.

44.1 References

1. Mikael A. Bramson: *Infrared Radiation, A Handbook for Applications*, Plenum press, N.Y.
2. William L. Wolfe, George J. Zissis: *The Infrared Handbook*, Office of Naval Research, Department of Navy, Washington, D.C.
3. Madding, R. P.: *Thermographic Instruments and systems*. Madison, Wisconsin: University of Wisconsin – Extension, Department of Engineering and Applied Science.
4. William L. Wolfe: *Handbook of Military Infrared Technology*, Office of Naval Research, Department of Navy, Washington, D.C.
5. Jones, Smith, Probert: *External thermography of buildings...*, Proc. of the Society of Photo-Optical Instrumentation Engineers, vol.110, Industrial and Civil Applications of Infrared Technology, June 1977 London.
6. Paljak, Pettersson: *Thermography of Buildings*, Swedish Building Research Institute, Stockholm 1972.
7. Vlcek, J: *Determination of emissivity with imaging radiometers and some emissivities at $\lambda = 5 \mu\text{m}$* . Photogrammetric Engineering and Remote Sensing.
8. Kern: *Evaluation of infrared emission of clouds and ground as measured by weather satellites*, Defence Documentation Center, AD 617 417.
9. Öhman, Claes: *Emittansmätningar med AGEMA E-Box*. Teknisk rapport, AGEMA 1999. (Emittance measurements using AGEMA E-Box. Technical report, AGEMA 1999.)
10. Mattei, S., Tang-Kwor, E: *Emissivity measurements for Nextel Velvet coating 811-21 between -36°C AND 82°C* .
11. Lohrengel & Todtenhaupt (1996)
12. ITC Technical publication 32.
13. ITC Technical publication 29.
14. Schuster, Norbert and Kolobrodov, Valentin G. *Infrarotthermographie*. Berlin: Wiley-VCH, 2000.

Note The emissivity values in the table below are recorded using a shortwave (SW) camera. The values should be regarded as recommendations only and used with caution.

44.2 Tables

Table 44.1 T: Total spectrum; SW: 2–5 μm ; LW: 8–14 μm , LLW: 6.5–20 μm ; 1: Material; 2: Specification; 3: Temperature in $^{\circ}\text{C}$; 4: Spectrum; 5: Emissivity; 6: Reference

1	2	3	4	5	6
3M type 35	Vinyl electrical tape (several colors)	< 80	LW	≈ 0.96	13
3M type 88	Black vinyl electrical tape	< 105	LW	≈ 0.96	13
3M type 88	Black vinyl electrical tape	< 105	MW	< 0.96	13
3M type Super 33+	Black vinyl electrical tape	< 80	LW	≈ 0.96	13
Aluminum	anodized sheet	100	T	0.55	2
Aluminum	anodized, black, dull	70	SW	0.67	9
Aluminum	anodized, black, dull	70	LW	0.95	9

Table 44.1 T: Total spectrum; SW: 2–5 μm ; LW: 8–14 μm , LLW: 6.5–20 μm ; 1: Material; 2: Specification; 3: Temperature in $^{\circ}\text{C}$; 4: Spectrum; 5: Emissivity; 6: Reference (continued)

1	2	3	4	5	6
Aluminum	anodized, light gray, dull	70	SW	0.61	9
Aluminum	anodized, light gray, dull	70	LW	0.97	9
Aluminum	as received, plate	100	T	0.09	4
Aluminum	as received, sheet	100	T	0.09	2
Aluminum	cast, blast cleaned	70	SW	0.47	9
Aluminum	cast, blast cleaned	70	LW	0.46	9
Aluminum	dipped in HNO_3 , plate	100	T	0.05	4
Aluminum	foil	27	10 μm	0.04	3
Aluminum	foil	27	3 μm	0.09	3
Aluminum	oxidized, strongly	50–500	T	0.2–0.3	1
Aluminum	polished	50–100	T	0.04–0.06	1
Aluminum	polished plate	100	T	0.05	4
Aluminum	polished, sheet	100	T	0.05	2
Aluminum	rough surface	20–50	T	0.06–0.07	1
Aluminum	roughened	27	10 μm	0.18	3
Aluminum	roughened	27	3 μm	0.28	3
Aluminum	sheet, 4 samples differently scratched	70	SW	0.05–0.08	9
Aluminum	sheet, 4 samples differently scratched	70	LW	0.03–0.06	9
Aluminum	vacuum deposited	20	T	0.04	2
Aluminum	weathered, heavily	17	SW	0.83–0.94	5
Aluminum bronze		20	T	0.60	1
Aluminum hydroxide	powder		T	0.28	1
Aluminum oxide	activated, powder		T	0.46	1
Aluminum oxide	pure, powder (alumina)		T	0.16	1
Asbestos	board	20	T	0.96	1
Asbestos	fabric		T	0.78	1
Asbestos	floor tile	35	SW	0.94	7
Asbestos	paper	40–400	T	0.93–0.95	1
Asbestos	powder		T	0.40–0.60	1
Asbestos	slate	20	T	0.96	1
Asphalt paving		4	LLW	0.967	8
Brass	dull, tarnished	20–350	T	0.22	1
Brass	oxidized	100	T	0.61	2
Brass	oxidized	70	SW	0.04–0.09	9

Table 44.1 T: Total spectrum; SW: 2–5 μm ; LW: 8–14 μm , LLW: 6.5–20 μm ; 1: Material; 2: Specification; 3: Temperature in $^{\circ}\text{C}$; 4: Spectrum; 5: Emissivity; 6: Reference (continued)

1	2	3	4	5	6
Brass	oxidized	70	LW	0.03–0.07	9
Brass	oxidized at 600 $^{\circ}\text{C}$	200–600	T	0.59–0.61	1
Brass	polished	200	T	0.03	1
Brass	polished, highly	100	T	0.03	2
Brass	rubbed with 80-grit emery	20	T	0.20	2
Brass	sheet, rolled	20	T	0.06	1
Brass	sheet, worked with emery	20	T	0.2	1
Brick	alumina	17	SW	0.68	5
Brick	common	17	SW	0.86–0.81	5
Brick	Dinas silica, glazed, rough	1100	T	0.85	1
Brick	Dinas silica, refractory	1000	T	0.66	1
Brick	Dinas silica, unglazed, rough	1000	T	0.80	1
Brick	firebrick	17	SW	0.68	5
Brick	fireclay	1000	T	0.75	1
Brick	fireclay	1200	T	0.59	1
Brick	fireclay	20	T	0.85	1
Brick	masonry	35	SW	0.94	7
Brick	masonry, plastered	20	T	0.94	1
Brick	red, common	20	T	0.93	2
Brick	red, rough	20	T	0.88–0.93	1
Brick	refractory, corundum	1000	T	0.46	1
Brick	refractory, magnesite	1000–1300	T	0.38	1
Brick	refractory, strongly radiating	500–1000	T	0.8–0.9	1
Brick	refractory, weakly radiating	500–1000	T	0.65–0.75	1
Brick	silica, 95% SiO_2	1230	T	0.66	1
Brick	sillimanite, 33% SiO_2 , 64% Al_2O_3	1500	T	0.29	1
Brick	waterproof	17	SW	0.87	5
Bronze	phosphor bronze	70	SW	0.08	9
Bronze	phosphor bronze	70	LW	0.06	9
Bronze	polished	50	T	0.1	1
Bronze	porous, rough	50–150	T	0.55	1
Bronze	powder		T	0.76–0.80	1
Carbon	candle soot	20	T	0.95	2
Carbon	charcoal powder		T	0.96	1
Carbon	graphite powder		T	0.97	1

Table 44.1 T: Total spectrum; SW: 2–5 μm ; LW: 8–14 μm , LLW: 6.5–20 μm ; 1: Material; 2: Specification; 3: Temperature in $^{\circ}\text{C}$; 4: Spectrum; 5: Emissivity; 6: Reference (continued)

1	2	3	4	5	6
Carbon	graphite, filed surface	20	T	0.98	2
Carbon	lampblack	20–400	T	0.95–0.97	1
Chipboard	untreated	20	SW	0.90	6
Chromium	polished	50	T	0.10	1
Chromium	polished	500–1000	T	0.28–0.38	1
Clay	fired	70	T	0.91	1
Cloth	black	20	T	0.98	1
Concrete		20	T	0.92	2
Concrete	dry	36	SW	0.95	7
Concrete	rough	17	SW	0.97	5
Concrete	walkway	5	LLW	0.974	8
Copper	commercial, burnished	20	T	0.07	1
Copper	electrolytic, carefully polished	80	T	0.018	1
Copper	electrolytic, polished	–34	T	0.006	4
Copper	molten	1100–1300	T	0.13–0.15	1
Copper	oxidized	50	T	0.6–0.7	1
Copper	oxidized to blackness		T	0.88	1
Copper	oxidized, black	27	T	0.78	4
Copper	oxidized, heavily	20	T	0.78	2
Copper	polished	50–100	T	0.02	1
Copper	polished	100	T	0.03	2
Copper	polished, commercial	27	T	0.03	4
Copper	polished, mechanical	22	T	0.015	4
Copper	pure, carefully prepared surface	22	T	0.008	4
Copper	scraped	27	T	0.07	4
Copper dioxide	powder		T	0.84	1
Copper oxide	red, powder		T	0.70	1
Ebonite			T	0.89	1
Emery	coarse	80	T	0.85	1
Enamel		20	T	0.9	1
Enamel	lacquer	20	T	0.85–0.95	1
Fiber board	hard, untreated	20	SW	0.85	6
Fiber board	masonite	70	SW	0.75	9
Fiber board	masonite	70	LW	0.88	9
Fiber board	particle board	70	SW	0.77	9
Fiber board	particle board	70	LW	0.89	9
Fiber board	porous, untreated	20	SW	0.85	6

Table 44.1 T: Total spectrum; SW: 2–5 µm; LW: 8–14 µm, LLW: 6.5–20 µm; 1: Material; 2: Specification; 3: Temperature in °C; 4: Spectrum; 5: Emissivity; 6: Reference (continued)

1	2	3	4	5	6
Glass pane (float glass)	non-coated	20	LW	0.97	14
Gold	polished	130	T	0.018	1
Gold	polished, carefully	200–600	T	0.02–0.03	1
Gold	polished, highly	100	T	0.02	2
Granite	polished	20	LLW	0.849	8
Granite	rough	21	LLW	0.879	8
Granite	rough, 4 different samples	70	SW	0.95–0.97	9
Granite	rough, 4 different samples	70	LW	0.77–0.87	9
Gypsum		20	T	0.8–0.9	1
Ice: See Water					
Iron and steel	cold rolled	70	SW	0.20	9
Iron and steel	cold rolled	70	LW	0.09	9
Iron and steel	covered with red rust	20	T	0.61–0.85	1
Iron and steel	electrolytic	100	T	0.05	4
Iron and steel	electrolytic	22	T	0.05	4
Iron and steel	electrolytic	260	T	0.07	4
Iron and steel	electrolytic, carefully polished	175–225	T	0.05–0.06	1
Iron and steel	freshly worked with emery	20	T	0.24	1
Iron and steel	ground sheet	950–1100	T	0.55–0.61	1
Iron and steel	heavily rusted sheet	20	T	0.69	2
Iron and steel	hot rolled	130	T	0.60	1
Iron and steel	hot rolled	20	T	0.77	1
Iron and steel	oxidized	100	T	0.74	4
Iron and steel	oxidized	100	T	0.74	1
Iron and steel	oxidized	1227	T	0.89	4
Iron and steel	oxidized	125–525	T	0.78–0.82	1
Iron and steel	oxidized	200	T	0.79	2
Iron and steel	oxidized	200–600	T	0.80	1
Iron and steel	oxidized strongly	50	T	0.88	1
Iron and steel	oxidized strongly	500	T	0.98	1
Iron and steel	polished	100	T	0.07	2
Iron and steel	polished	400–1000	T	0.14–0.38	1
Iron and steel	polished sheet	750–1050	T	0.52–0.56	1
Iron and steel	rolled sheet	50	T	0.56	1
Iron and steel	rolled, freshly	20	T	0.24	1
Iron and steel	rough, plane surface	50	T	0.95–0.98	1
Iron and steel	rusted red, sheet	22	T	0.69	4
Iron and steel	rusted, heavily	17	SW	0.96	5

Table 44.1 T: Total spectrum; SW: 2–5 μm ; LW: 8–14 μm , LLW: 6.5–20 μm ; 1: Material; 2: Specification; 3: Temperature in $^{\circ}\text{C}$; 4: Spectrum; 5: Emissivity; 6: Reference (continued)

1	2	3	4	5	6
Iron and steel	rusty, red	20	T	0.69	1
Iron and steel	shiny oxide layer, sheet,	20	T	0.82	1
Iron and steel	shiny, etched	150	T	0.16	1
Iron and steel	wrought, carefully polished	40–250	T	0.28	1
Iron galvanized	heavily oxidized	70	SW	0.64	9
Iron galvanized	heavily oxidized	70	LW	0.85	9
Iron galvanized	sheet	92	T	0.07	4
Iron galvanized	sheet, burnished	30	T	0.23	1
Iron galvanized	sheet, oxidized	20	T	0.28	1
Iron tinned	sheet	24	T	0.064	4
Iron, cast	casting	50	T	0.81	1
Iron, cast	ingots	1000	T	0.95	1
Iron, cast	liquid	1300	T	0.28	1
Iron, cast	machined	800–1000	T	0.60–0.70	1
Iron, cast	oxidized	100	T	0.64	2
Iron, cast	oxidized	260	T	0.66	4
Iron, cast	oxidized	38	T	0.63	4
Iron, cast	oxidized	538	T	0.76	4
Iron, cast	oxidized at 600 $^{\circ}\text{C}$	200–600	T	0.64–0.78	1
Iron, cast	polished	200	T	0.21	1
Iron, cast	polished	38	T	0.21	4
Iron, cast	polished	40	T	0.21	2
Iron, cast	unworked	900–1100	T	0.87–0.95	1
Krylon Ultra-flat black 1602	Flat black	Room temperature up to 175	LW	≈ 0.96	12
Krylon Ultra-flat black 1602	Flat black	Room temperature up to 175	MW	≈ 0.97	12
Lacquer	3 colors sprayed on Aluminum	70	SW	0.50–0.53	9
Lacquer	3 colors sprayed on Aluminum	70	LW	0.92–0.94	9
Lacquer	Aluminum on rough surface	20	T	0.4	1
Lacquer	bakelite	80	T	0.83	1
Lacquer	black, dull	40–100	T	0.96–0.98	1
Lacquer	black, matte	100	T	0.97	2
Lacquer	black, shiny, sprayed on iron	20	T	0.87	1
Lacquer	heat-resistant	100	T	0.92	1
Lacquer	white	100	T	0.92	2
Lacquer	white	40–100	T	0.8–0.95	1
Lead	oxidized at 200 $^{\circ}\text{C}$	200	T	0.63	1
Lead	oxidized, gray	20	T	0.28	1

Table 44.1 T: Total spectrum; SW: 2–5 µm; LW: 8–14 µm, LLW: 6.5–20 µm; 1: Material; 2: Specification; 3: Temperature in °C; 4: Spectrum; 5: Emissivity; 6: Reference (continued)

1	2	3	4	5	6
Lead	oxidized, gray	22	T	0.28	4
Lead	shiny	250	T	0.08	1
Lead	unoxidized, polished	100	T	0.05	4
Lead red		100	T	0.93	4
Lead red, powder		100	T	0.93	1
Leather	tanned		T	0.75–0.80	1
Lime			T	0.3–0.4	1
Magnesium		22	T	0.07	4
Magnesium		260	T	0.13	4
Magnesium		538	T	0.18	4
Magnesium	polished	20	T	0.07	2
Magnesium powder			T	0.86	1
Molybdenum		1500–2200	T	0.19–0.26	1
Molybdenum		600–1000	T	0.08–0.13	1
Molybdenum	filament	700–2500	T	0.1–0.3	1
Mortar		17	SW	0.87	5
Mortar	dry	36	SW	0.94	7
Nextel Velvet 811-21 Black	Flat black	–60–150	LW	> 0.97	10 and 11
Nichrome	rolled	700	T	0.25	1
Nichrome	sandblasted	700	T	0.70	1
Nichrome	wire, clean	50	T	0.65	1
Nichrome	wire, clean	500–1000	T	0.71–0.79	1
Nichrome	wire, oxidized	50–500	T	0.95–0.98	1
Nickel	bright matte	122	T	0.041	4
Nickel	commercially pure, polished	100	T	0.045	1
Nickel	commercially pure, polished	200–400	T	0.07–0.09	1
Nickel	electrolytic	22	T	0.04	4
Nickel	electrolytic	260	T	0.07	4
Nickel	electrolytic	38	T	0.06	4
Nickel	electrolytic	538	T	0.10	4
Nickel	electroplated on iron, polished	22	T	0.045	4
Nickel	electroplated on iron, unpolished	20	T	0.11–0.40	1
Nickel	electroplated on iron, unpolished	22	T	0.11	4
Nickel	electroplated, polished	20	T	0.05	2
Nickel	oxidized	1227	T	0.85	4
Nickel	oxidized	200	T	0.37	2
Nickel	oxidized	227	T	0.37	4

Table 44.1 T: Total spectrum; SW: 2–5 µm; LW: 8–14 µm, LLW: 6.5–20 µm; 1: Material; 2: Specification; 3: Temperature in °C; 4: Spectrum; 5: Emissivity; 6: Reference (continued)

1	2	3	4	5	6
Nickel	oxidized at 600°C	200–600	T	0.37–0.48	1
Nickel	polished	122	T	0.045	4
Nickel	wire	200–1000	T	0.1–0.2	1
Nickel oxide		1000–1250	T	0.75–0.86	1
Nickel oxide		500–650	T	0.52–0.59	1
Oil, lubricating	0.025 mm film	20	T	0.27	2
Oil, lubricating	0.050 mm film	20	T	0.46	2
Oil, lubricating	0.125 mm film	20	T	0.72	2
Oil, lubricating	film on Ni base: Ni base only	20	T	0.05	2
Oil, lubricating	thick coating	20	T	0.82	2
Paint	8 different colors and qualities	70	SW	0.88–0.96	9
Paint	8 different colors and qualities	70	LW	0.92–0.94	9
Paint	Aluminum, vari- ous ages	50–100	T	0.27–0.67	1
Paint	cadmium yellow		T	0.28–0.33	1
Paint	chrome green		T	0.65–0.70	1
Paint	cobalt blue		T	0.7–0.8	1
Paint	oil	17	SW	0.87	5
Paint	oil based, aver- age of 16 colors	100	T	0.94	2
Paint	oil, black flat	20	SW	0.94	6
Paint	oil, black gloss	20	SW	0.92	6
Paint	oil, gray flat	20	SW	0.97	6
Paint	oil, gray gloss	20	SW	0.96	6
Paint	oil, various colors	100	T	0.92–0.96	1
Paint	plastic, black	20	SW	0.95	6
Paint	plastic, white	20	SW	0.84	6
Paper	4 different colors	70	SW	0.68–0.74	9
Paper	4 different colors	70	LW	0.92–0.94	9
Paper	black		T	0.90	1
Paper	black, dull		T	0.94	1
Paper	black, dull	70	SW	0.86	9
Paper	black, dull	70	LW	0.89	9
Paper	blue, dark		T	0.84	1
Paper	coated with black lacquer		T	0.93	1
Paper	green		T	0.85	1
Paper	red		T	0.76	1
Paper	white	20	T	0.7–0.9	1
Paper	white bond	20	T	0.93	2
Paper	white, 3 different glosses	70	SW	0.76–0.78	9

Table 44.1 T: Total spectrum; SW: 2–5 µm; LW: 8–14 µm, LLW: 6.5–20 µm; 1: Material; 2: Specification; 3: Temperature in °C; 4: Spectrum; 5: Emissivity; 6: Reference (continued)

1	2	3	4	5	6
Paper	white, 3 different glosses	70	LW	0.88–0.90	9
Paper	yellow		T	0.72	1
Plaster		17	SW	0.86	5
Plaster	plasterboard, untreated	20	SW	0.90	6
Plaster	rough coat	20	T	0.91	2
Plastic	glass fibre laminate (printed circ. board)	70	SW	0.94	9
Plastic	glass fibre laminate (printed circ. board)	70	LW	0.91	9
Plastic	polyurethane isolation board	70	LW	0.55	9
Plastic	polyurethane isolation board	70	SW	0.29	9
Plastic	PVC, plastic floor, dull, structured	70	SW	0.94	9
Plastic	PVC, plastic floor, dull, structured	70	LW	0.93	9
Platinum		100	T	0.05	4
Platinum		1000–1500	T	0.14–0.18	1
Platinum		1094	T	0.18	4
Platinum		17	T	0.016	4
Platinum		22	T	0.03	4
Platinum		260	T	0.06	4
Platinum		538	T	0.10	4
Platinum	pure, polished	200–600	T	0.05–0.10	1
Platinum	ribbon	900–1100	T	0.12–0.17	1
Platinum	wire	1400	T	0.18	1
Platinum	wire	500–1000	T	0.10–0.16	1
Platinum	wire	50–200	T	0.06–0.07	1
Porcelain	glazed	20	T	0.92	1
Porcelain	white, shiny		T	0.70–0.75	1
Rubber	hard	20	T	0.95	1
Rubber	soft, gray, rough	20	T	0.95	1
Sand			T	0.60	1
Sand		20	T	0.90	2
Sandstone	polished	19	LLW	0.909	8
Sandstone	rough	19	LLW	0.935	8
Silver	polished	100	T	0.03	2
Silver	pure, polished	200–600	T	0.02–0.03	1
Skin	human	32	T	0.98	2
Slag	boiler	0–100	T	0.97–0.93	1
Slag	boiler	1400–1800	T	0.69–0.67	1
Slag	boiler	200–500	T	0.89–0.78	1

Table 44.1 T: Total spectrum; SW: 2–5 μm ; LW: 8–14 μm , LLW: 6.5–20 μm ; 1: Material; 2: Specification; 3: Temperature in $^{\circ}\text{C}$; 4: Spectrum; 5: Emissivity; 6: Reference (continued)

1	2	3	4	5	6
Slag	boiler	600–1200	T	0.76–0.70	1
Snow: See Water					
Soil	dry	20	T	0.92	2
Soil	saturated with water	20	T	0.95	2
Stainless steel	alloy, 8% Ni, 18% Cr	500	T	0.35	1
Stainless steel	rolled	700	T	0.45	1
Stainless steel	sandblasted	700	T	0.70	1
Stainless steel	sheet, polished	70	SW	0.18	9
Stainless steel	sheet, polished	70	LW	0.14	9
Stainless steel	sheet, untreated, somewhat scratched	70	SW	0.30	9
Stainless steel	sheet, untreated, somewhat scratched	70	LW	0.28	9
Stainless steel	type 18-8, buffed	20	T	0.16	2
Stainless steel	type 18-8, oxidized at 800 $^{\circ}\text{C}$	60	T	0.85	2
Stucco	rough, lime	10–90	T	0.91	1
Styrofoam	insulation	37	SW	0.60	7
Tar			T	0.79–0.84	1
Tar	paper	20	T	0.91–0.93	1
Tile	glazed	17	SW	0.94	5
Tin	burnished	20–50	T	0.04–0.06	1
Tin	tin-plated sheet iron	100	T	0.07	2
Titanium	oxidized at 540 $^{\circ}\text{C}$	1000	T	0.60	1
Titanium	oxidized at 540 $^{\circ}\text{C}$	200	T	0.40	1
Titanium	oxidized at 540 $^{\circ}\text{C}$	500	T	0.50	1
Titanium	polished	1000	T	0.36	1
Titanium	polished	200	T	0.15	1
Titanium	polished	500	T	0.20	1
Tungsten		1500–2200	T	0.24–0.31	1
Tungsten		200	T	0.05	1
Tungsten		600–1000	T	0.1–0.16	1
Tungsten	filament	3300	T	0.39	1
Varnish	flat	20	SW	0.93	6
Varnish	on oak parquet floor	70	SW	0.90	9
Varnish	on oak parquet floor	70	LW	0.90–0.93	9
Wallpaper	slight pattern, light gray	20	SW	0.85	6
Wallpaper	slight pattern, red	20	SW	0.90	6
Water	distilled	20	T	0.96	2

Table 44.1 T: Total spectrum; SW: 2–5 μm ; LW: 8–14 μm , LLW: 6.5–20 μm ; 1: Material; 2: Specification; 3: Temperature in $^{\circ}\text{C}$; 4: Spectrum; 5: Emissivity; 6: Reference (continued)

1	2	3	4	5	6
Water	frost crystals	-10	T	0.98	2
Water	ice, covered with heavy frost	0	T	0.98	1
Water	ice, smooth	0	T	0.97	1
Water	ice, smooth	-10	T	0.96	2
Water	layer >0.1 mm thick	0–100	T	0.95–0.98	1
Water	snow		T	0.8	1
Water	snow	-10	T	0.85	2
Wood		17	SW	0.98	5
Wood		19	LLW	0.962	8
Wood	ground		T	0.5–0.7	1
Wood	pine, 4 different samples	70	SW	0.67–0.75	9
Wood	pine, 4 different samples	70	LW	0.81–0.89	9
Wood	planed	20	T	0.8–0.9	1
Wood	planed oak	20	T	0.90	2
Wood	planed oak	70	SW	0.77	9
Wood	planed oak	70	LW	0.88	9
Wood	plywood, smooth, dry	36	SW	0.82	7
Wood	plywood, untreated	20	SW	0.83	6
Wood	white, damp	20	T	0.7–0.8	1
Zinc	oxidized at 400 $^{\circ}\text{C}$	400	T	0.11	1
Zinc	oxidized surface	1000–1200	T	0.50–0.60	1
Zinc	polished	200–300	T	0.04–0.05	1
Zinc	sheet	50	T	0.20	1

A note on the technical production of this publication

This publication was produced using XML — the eXtensible Markup Language. For more information about XML, please visit <http://www.w3.org/XML/>

A note on the typeface used in this publication

This publication was typeset using Linotype Helvetica™ World. Helvetica™ was designed by Max Miedinger (1910–1980)

LOEF (List Of Effective Files)

T501131.xml; en-US; AR; 46651; 2017-11-30
T505864.xml; en-US; 26038; 2015-05-27
T505469.xml; en-US; 39689; 2017-01-25
T505013.xml; en-US; 39689; 2017-01-25
T505819.xml; en-US; 45118; 2017-09-20
T505889.xml; en-US; 39867; 2017-01-31
T505820.xml; en-US; 46564; 2017-11-23
T505821.xml; en-US; 39867; 2017-01-31
T505822.xml; en-US; 45120; 2017-09-20
T505824.xml; en-US; 44996; 2017-09-14
T505825.xml; en-US; 45315; 2017-09-25
T505826.xml; en-US; 45711; 2017-10-11
T505827.xml; en-US; 45218; 2017-09-21
T506154.xml; en-US; 45609; 2017-10-04
T505853.xml; en-US; 46198; 2017-11-06
T505476.xml; en-US; 39581; 2017-01-20
T505012.xml; en-US; 41563; 2017-03-23
T505007.xml; en-US; 42810; 2017-05-23
T506125.xml; en-US; 40753; 2017-03-02
T505000.xml; en-US; 39687; 2017-01-25
T506051.xml; en-US; 40460; 2017-02-20
T505005.xml; en-US; 43349; 2017-06-14
T505001.xml; en-US; 41563; 2017-03-23
T505006.xml; en-US; 41563; 2017-03-23
T505002.xml; en-US; 39512; 2017-01-18



Website

<http://www.flir.com>

Customer support

<http://support.flir.com>

Copyright

© 2017, FLIR Systems, Inc. All rights reserved worldwide.

Disclaimer

Specifications subject to change without further notice. Models and accessories subject to regional market considerations. License procedures may apply. Products described herein may be subject to US Export Regulations. Please refer to exportquestions@flir.com with any questions.

Publ. No.: T559954
Release: AR
Commit: 46651
Head: 46651
Language: en-US
Modified: 2017-11-30
Formatted: 2017-11-30