FOTRIC

Handheld Acoutherm Imager User Manual



FOTRIC INC.

June, 2024

1 Preface

Symbols

 Warnings	 Caution
Potential death or serious injury inducing hazards	Potential danger of injury or property damage

Safety Information

The purpose of this content is to ensure that the user uses this product properly to avoid danger or property damage. Before using this product, please read this instruction manual carefully and keep it in a safe place for future reference.

Warning:

- Do not disassemble or modify the product battery. The battery is equipped with safety and protective devices which, if tampered with, may cause the battery to overheat or even result in explosion or combustion. If the battery is leaking and the leakage gets into your eyes do not rub it, wash it with water and go to a hospital immediately.
- The product uses a laser pointer. Do not stare at the laser beam directly. It can cause eye irritation.

- If the unit is not working properly, please contact your dealer or our company and do not disassemble or modify the unit in any way (unauthorized modifications or repairs cause problems at your own risk).

**Attention:**

- Avoid using the product in humid, dusty, extremely hot or cold environments, see the product's data sheet for specific temperature and humidity requirements.
- Do not touch the sensor or lens part directly to avoid stain and damage from oil and various chemicals. If cleaning is necessary, moisten a clean cloth slightly and gently wipe off the dust. Close the lens cap when the camera is not in use.
- Once the thermal camera is turned on, a warm-up process of approximately 5-10 minutes may be required before accurate readings can be taken.
- Avoid focusing on or prolonged exposure to the sun or objects with extremely high temperatures, as this may result in reduced sensor life span or temporary dark spots (minor cases can be resolved after conducting the NUC, severe cases may result in irreversible damage to the detector).
- Avoid selecting the inappropriate temperature range. It may damage the sensor.
- It is strongly recommended to use the original power adapter, the specific requirements of the power adapter are shown in the product parameter table.
- To prevent the potential danger of data loss, always copy (back up) your data to your computer.
- When storing the product, it is strongly recommended to use the original box and place it in a cool, dry, ventilated environment free from strong electromagnetic

fields.

- When shipping the camera, it is highly recommended that it be shipped and protected in factory packaging.

Table of Content

1	PREFACE	2
2	ACOUTHERM IMAGER COMPONENTS	11
2.1	FRONT VIEW	11
2.2	REAR VIEW.....	12
2.3	LEFT VIEW	13
2.4	RIGHT VIEW	14
2.5	TOP VIEW.....	15
3	OPERATION GUIDE	15
3.1	CHARGING THE BATTERY	15
3.2	TURNING THE ACOUTHERM IMAGER ON AND OFF	16
3.3	MANUALLY ADJUSTING THE INFRARED LENS.....	16
3.4	TURBOFOCUS FOCUSING SYSTEM	18
3.5	CONTINUOUS AUTOFOCUS	19
3.6	CHANGING THERMAL CAMERA LENS.....	19
3.7	TRANSFERRING DATA TO A COMPUTER WITH SD CARD.....	20
3.8	DATA TRANSFER THROUGH USB CONNECTION	21
3.9	LASER DISTANCE METER.....	21
3.10	MEASURING AREAS	23
3.11	MEASURING LENGTH.....	24
3.12	AI BUTTON (PROGRAMMABLE KEY).....	25
3.13	GALLERY.....	27

3.14	CALIBRATION (NUC)	27
4	MAIN INTERFACE.....	28
4.1	THERMAL IMAGING INTERFACE.....	28
	<i>3.1.1 Overview</i>	<i>28</i>
	1. Status bar	28
	2. Measurement results	29
	3. System menu	29
	4. Measurement parameters.....	29
	5. Color palette	30
	6. Image display	30
	<i>3.1.2 Swipe-down menu.....</i>	<i>30</i>
	3.1.2.1 Hide all overlays	32
	<i>3.1.3 Real-time digital zoom.....</i>	<i>33</i>
	<i>3.1.4 System menu</i>	<i>33</i>
	3.1.4.1 Temperature scale mode.....	34
	3.1.4.2 Measurement parameters	41
	3.1.4.2 Image mode	50
	3.1.4.4 ROI measurement tools.....	53
	3.1.4.5 Palette	64
4.2	ACOUSTIC IMAGING INTERFACE	70
	<i>3.2.1 Overview.....</i>	<i>70</i>
4.3	70
	3.2.1.1 Status bar	70
	3.2.1.2. Diagnostic result	71
	3.2.1.3 System menu	72
5	SYSTEM SETTINGS.....	79
5.1	CAPTURE MODE.....	80
	<i>4.1.1 Video recording</i>	<i>81</i>
	<i>4.1.2 Time-lapse</i>	<i>82</i>
5.2	CONNECTION	83

5.2.1	<i>IRExplorer</i>	83
5.2.2	<i>WLAN (Wi-Fi)</i>	84
5.2.3	<i>Portable hotspot</i>	86
5.2.4	<i>Bluetooth</i>	87
5.2.5	<i>FTP data transfer</i>	88
5.3	TEMPERATURE RANGE (ONLY VISIBLE IN IR MODE)	89
5.4	STORAGE & SAVING OPTIONS.....	90
5.5	DEVICE SET	92
5.5.1	<i>Language & date & region</i>	93
5.5.2	<i>USB mode</i>	97
5.5.3	<i>Display</i>	98
5.5.4	<i>Location</i>	98
5.5.5	<i>LED lamp as flash light</i>	99
5.5.6	<i>Screen off</i>	100
5.5.7	<i>Volume</i>	101
5.5.8	<i>Reset</i>	101
5.5.9	<i>About</i>	102
5.6	IR DEVICE SET	103
4.6.1	<i>Focus</i>	104
4.6.2	<i>T-TWB® and IREdge</i>	105
4.6.3	<i>Image overlay</i>	105
4.6.4	<i>T-DEF IR alpha</i>	106

4.6.5	Manual mode	107
5.7	AC DEVICE SET.....	108
4.7.1	Leak parameters	109
4.7.2	AC focus range.....	110
4.7.3	Frequency config.....	110
4.7.4	Show dB value.....	112
4.7.5	AC frequency	112
4.7.6	SPL normalization	112
4.7.7	Measurement enhancement	112
5.8	PLUG-IN SETTINGS	113
4.8.1	Plug-in manager.....	113
5.8.2	Service plug-in	113
6	IMAGE FREEZE INTERFACE	114
6.1	IR MODE.....	114
5.1.1	Favorite	115
5.1.2	Voice annotation.....	116
5.1.3	Text annotation.....	116
5.1.4	Keypad input.....	118
5.1.5	Tag and auto-naming	118
5.1.5.1	Keypad input	120
5.1.5.2	OCR text recognition.....	120
5.1.5.3	QR code scanning.....	121
6.2	AC IMAGES.....	121
6.2.1	Source mode.....	122

5.2.2	Measurement tools.....	124
5.2.3	Favorite	125
5.2.4	Voice annotation	125
5.2.5	Text annotation	125
5.2.6	Tag	125
7	GALLERY.....	125
7.1	FAVORITE.....	126
7.2	FILTER.....	127
7.3	OPEN IMAGE AND VIDEO FILES.....	128
7.4	THERMAL IMAGE FILE ANALYSIS	129
7.5	THERMAL VIDEO ANALYSIS	130
7.6	DELETING AN IMAGE OR VIDEO FILE	132
7.7	DELETE MULTIPLE FILES	133
8	CAMERA MAINTENANCE	134
8.1	CLEANING THE CAMERA CASE, CABLES AND OTHER COMPONENTS	134
8.2	CLEANING THE INFRARED LENS	134
8.2.1	Solvent.....	134
8.2.2	Notes	134
8.3	CLEANING UNCOOLED INFRARED FOCAL PLANE DETECTORS.....	135
8.4	LITHIUM BATTERY MAINTENANCE	136
9	GLOSSARY.....	137
10	HISTORY OF THERMAL IMAGING.....	149
11	PRINCIPLES OF THERMAL IMAGING.....	151

11.1	SUMMARY.....	151
11.2	ELECTROMAGNETIC SPECTRUM.....	151
11.3	INFRARED LIGHT.....	152
11.4	ATMOSPHERIC WINDOW.....	152
11.5	BLACK BODY RADIATION (IN THERMODYNAMICS).....	153
11.6	PLANCK'S LAW.....	154
11.7	STEPHEN BOLTZMANN'S LAW.....	155
12	MATERIAL EMISSIVITY TABLE.....	156
13	HOW TO SET EMISSIVITY.....	159
13.1	EMISSIVITY.....	162
13.2	EMISSIVITY SETTING.....	163
14	ABOUT THIS MANUAL.....	164

2 Acoutherm Imager Components

2.1 Front View

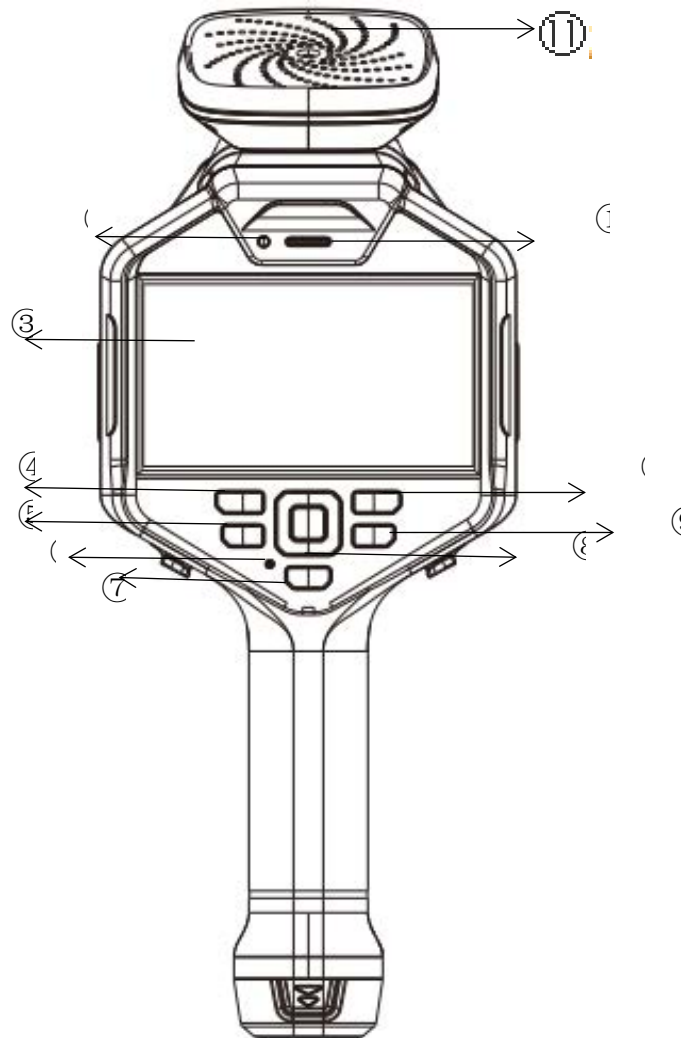

- ① Speaker
- ② Status light
- ③ 5" LCD screen
- ④ Power button
- ⑤ LED button
- ⑥ Microphone
- ⑦ AI button
- ⑧ Confirm button and arrow keys
- ⑨ Back button
- ⑩ Gallery button
- ⑪ Acoustic imaging module

2.2 Rear View

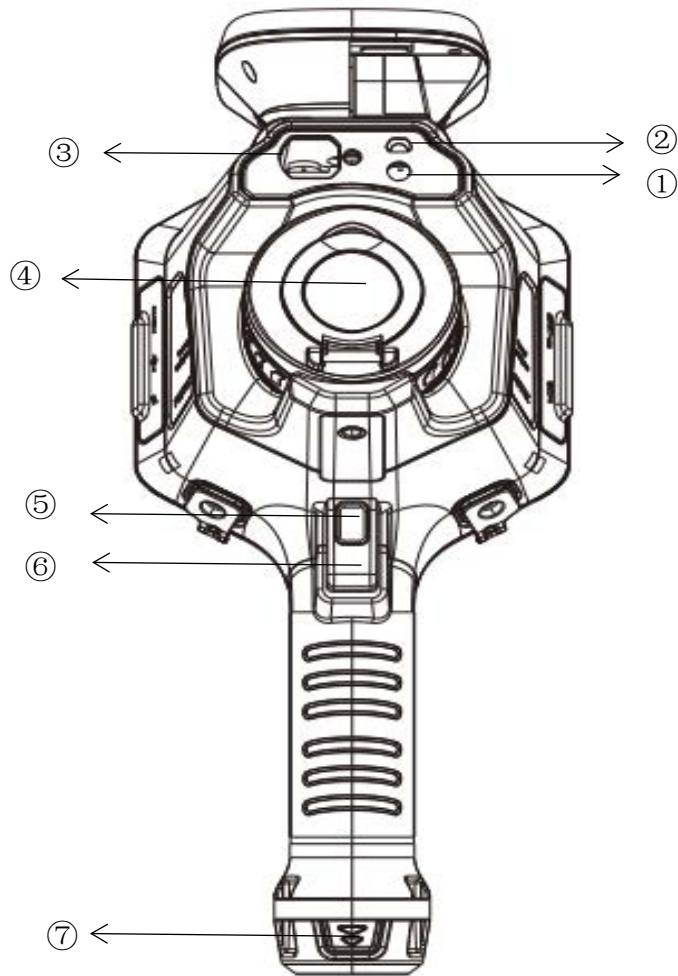

① Digital camera

② LED flash light

③ Laser ranger

④ Lens cap

⑤ Autofocus button

⑥ Freeze image and snapshot button

⑦ Battery

2.3 Left View

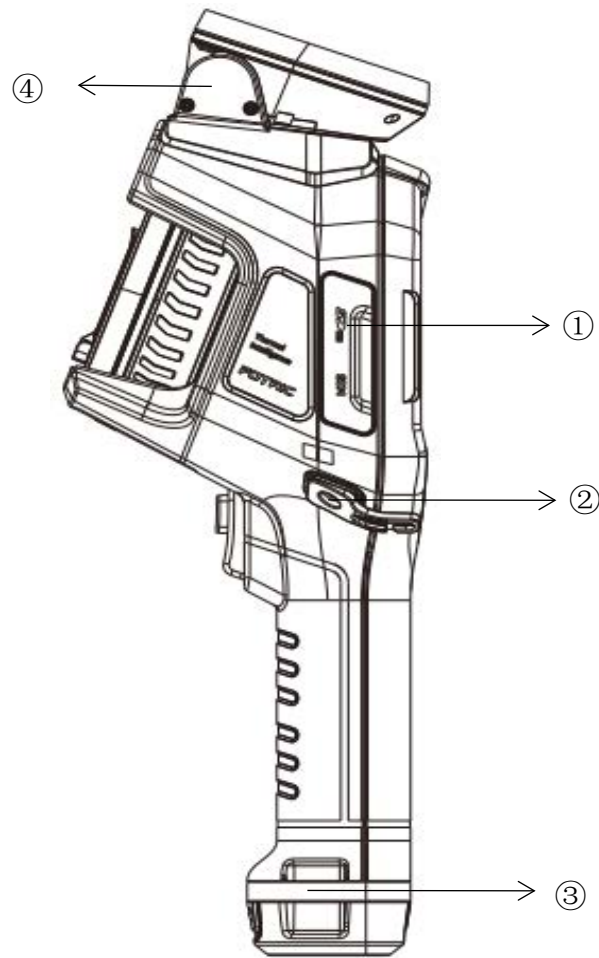

① SD card socket

③ Wrist strap

② Wrist strap bracket fixing point

④ Acoustic module

2.4 Right View

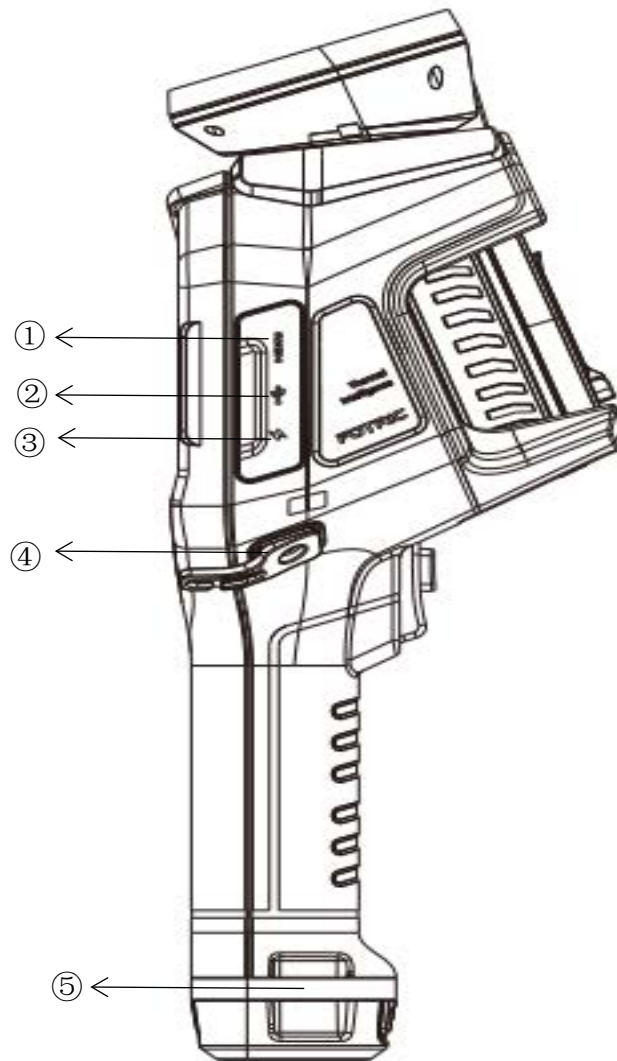

① Micro-HDMI interface

② USB Type-C interface

③ Power Supply interface

④ Wrist strap bracket fixing point

⑤ Wrist strap

2.5 Top View

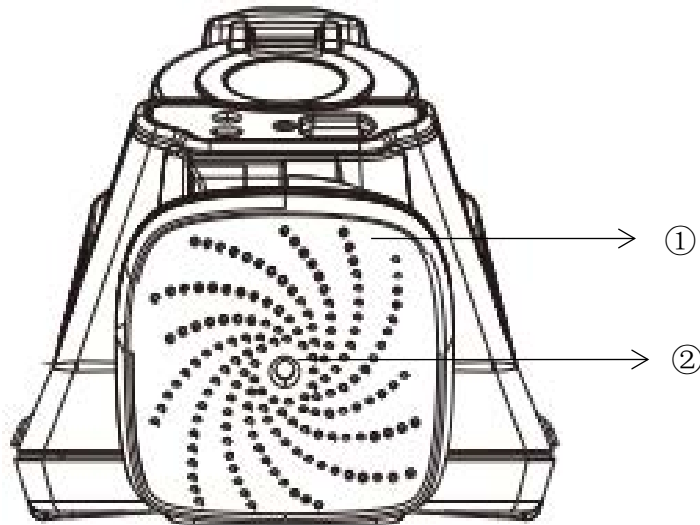

① Microphone array

② Digital camera

3 Operation Guide





3.1 Charging the Battery

Note: Please charge the battery with accompanying battery charging dock.

LED indicator lamp on the accompanying dual battery charger

Signal Type	Meaning
The LED flashes in green/ glows continuously in red	The battery is charging
The LED glows continuously in green	The battery is fully charged

3.2 Turning the Acoutherm Imager on and off

- To turn on the imager, long press the Power Button ;
- Then the imager is on, long press the Power Button  (about 5 seconds) to bring up the selection menus "Shutdown" and "Reboot", which allow the imager to shut down and reboot the imager respectively;
- Short press the Power Button  in the power-on state, to turn off the screen;
- When the screen is off, press the Power Button  to wake up the screen.

3.3 Manually Adjusting the Infrared Lens

Operational illustrations

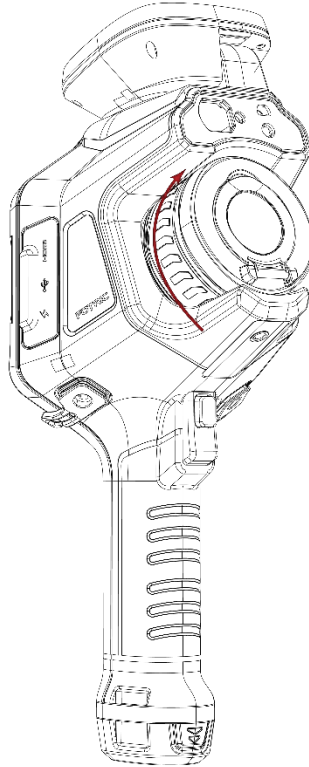

- To focus far, rotate the focus ring clockwise (with the LCD screen facing towards the user);
- To focus near, turn the focus ring counterclockwise (with the LCD screen facing towards).

3.4 TurboFocus Focusing System

FOTRIC TurboFocus auto focus system supports thermal image contrast focus and laser distance focus modes.

- 1) Thermal image contrast focus: The focus system performs Autofocus based on maximizing optimize the thermal image contrast;
- 2) Laser distance focus: The focus system performs Autofocus by Laser distancemeasurement between the thermal imager and the target;
3. The focus modes can be configured through settings. Select System Menu→ Settings → Device Set → Focus → Autofocus, and then select CT (Thermal Image Contrast) or Laser.

Focusing operation

Use the autofocus by pressing the "Autofocus" button in the figure below.

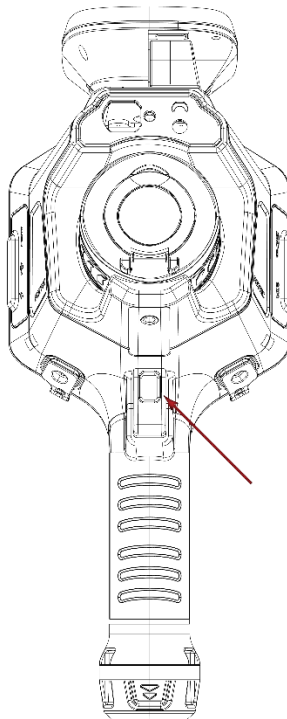

3.5 Continuous Autofocus

When the continuous Autofocus function is turned on, the thermal imager will continuously and automatically adjust the focal length according to the measured objects at different distances in the scene by performing thermal image contrast or laser distance.

Setup Steps

1. Go to System Menu -> Settings ->IR Device Set -> Focus -> Autofocus -> Laser/Contrast;
2. Go to System Menu->Settings->IR Device Set->Focus->Continuous AF->On/Off.
3. Go to System Menu->Settings->IR Device Set->Focus->Touch Screen Focus->On/Off

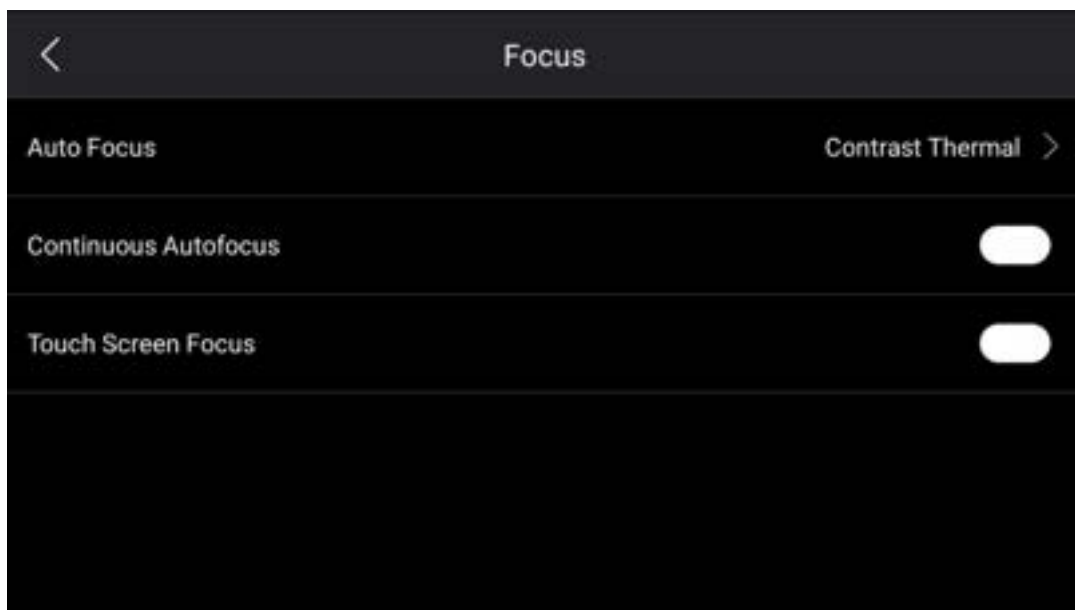

3.6 Changing Thermal Camera Lens

1. Holding down the lens lock(the blue block) by the lens, rotate the lens counterclockwise to remove it;
2. Align the new lens to the mounting point, insert the lens and rotate clockwise

to complete the replacement;

3. The imager automatically recognizes new lenses and performs temperature calibration to ensure temperature measurement accuracy.
4. 7-degree ultra-telephoto lens can also be part of the product configuration. Switching to the 7-degree lens will disable the visible light mode, picture-in-picture and T-DEF blend modes.

3.7 Transferring Data to a Computer with SD Card

When saving images or video clips in the acoutherm imager's gallery, the files are stored on a SD memory card. With SD card reader, the files can be transferred to a computer.

Operating Procedures:

- Take out the acoutherm imager SD memory card;
- Insert the SD card into the card reader, and then insert the card reader into the USB interface of the computer;
- Open the Gallery folder from the SD card on PC;
- Import the files into AnalyzIR for professional analysis;
- Remove the SD card and insert it back into the acoutherm imager, the memory card LED indicator lights up.

! Attention:

- Do not eject the memory card while this LED is blinking;
- Do not connect the acoutherm imager to the computer while the LED is blinking.

3.8 Data Transfer through USB Connection

The acoutherm camera can be connected to a computer with a USB cable. Once the connection is established, image and video files can be transferred from the memory card to the computer.

Operating Procedure:

1. Turn on the acoutherm imager;
2. Open the flap of the connection interface cover and plug the USB cable to the USB Type-C interface. Connect the other end of the USB cable to the computer;
3. In File Explorer, open the Gallery folder and move the desired files to your computer;

3.9 Laser Distance Meter







The laser distance meter contains a laser emitter and a laser rangefinder. It determines

the distance to a target by measuring the time it takes for a laser pulse to reach the target and return to the laser receiver. This time is converted to distance, which is displayed on the screen.

The laser emitter also works as a laser pointer. When the laser distance meter is on, the user will see a laser dot approximately on the target. The thermal imager can be configured to automatically measure the distance when save image.

Operating Procedure

1. To turn on the laser, press and hold the laser button  in the figure  ;
2. When the laser is turned on, the  symbol will be displayed on the screen and the laser dot position and distance will be shown on the screen;
3. To turn off the laser, release the laser button  .

To automatically update the test distance in the picture parameters when taking a picture, select System Menu >  (Settings) > Save & Storage Options > Save Laser Distance. (it won't affect distance setting in the when doing measurements Live.)

! Note: Laser ranging takes about 2s to calculate;

! Note: Laser ranging result will reserve two decimal places;

! Note: If the target reflection is too low or the target surface is at an angle to the laser beam, there may be no return signal and the distance cannot be measured.

3.10 Measuring Areas

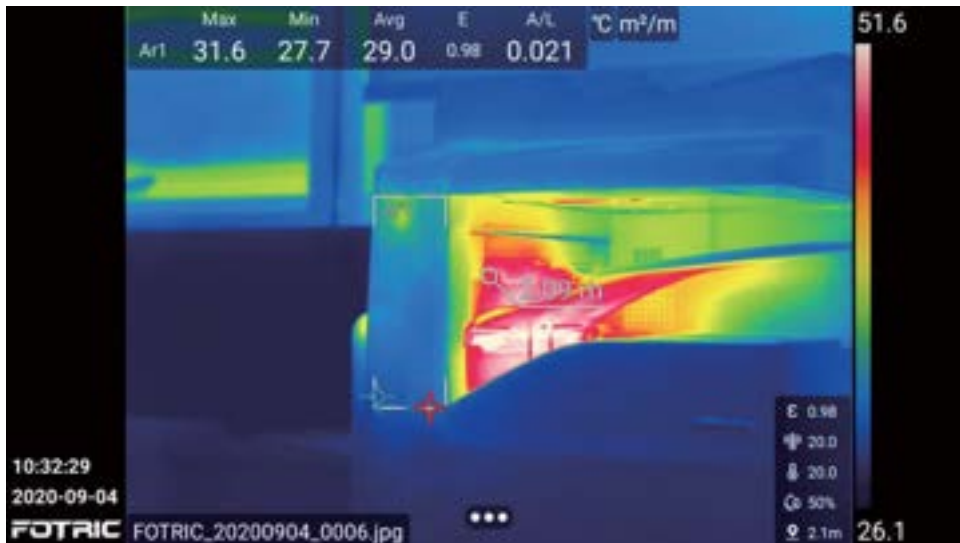

To measure areas, add a temperature measurement rectangle or circle on the screen. The thermal imager will calculate the area of the rectangle or circle, according to the distance of the target. When the laser distance meter is turned on, a laser dot can be seen on the measured target. The thermal imager assumes that this distance is valid to the measurement area of the entire rectangle or circle.

1. Make sure the "Save Laser Distance" is selected, in "Save & Storage Options" .
2. Add a box or circle measurement tool;
3. Make sure the box or circle tool is in the center of the image;
4. Adjust the size of the box or circle tool to match the size of the target;
5. Keep the imager perpendicular to the target. Press and hold the laser button  ;
6. The calculated area will be displayed in the results table.

! Note: Avoid aiming areas with multiple complex targets at different distances

from the imager, which can lead to measurement errors.

3.11 Measuring length

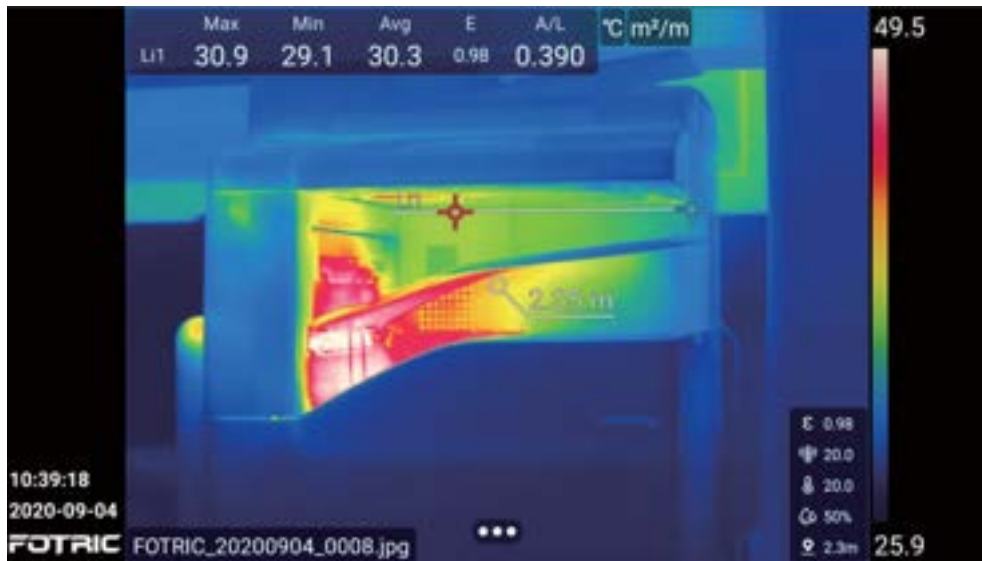

To measure the length, add a temperature measurement line on the screen. The imager will calculate the length of the line based on the measured distance to the target. When the laser ranger is turned on, a laser dot is visible on the target being measured. The laser ranger measures the distance to that target.

Please follow setting procedures as below:

1. Make sure the “Save Laser Distance” is selected, in “Save & Storage Options”.
2. Add a temperature measurement line.
3. Make sure the temperature measurement line is close to the center of the image.
4. Adjust the length and direction of the temperature measurement line to match the target.
5. Keep the thermal imager perpendicular to the target. Press the capture button.

! Note: Avoid aiming areas with multiple complex targets at different distances from the imager, which can lead to measurement errors.

3.12 AI Button (Programmable Key)

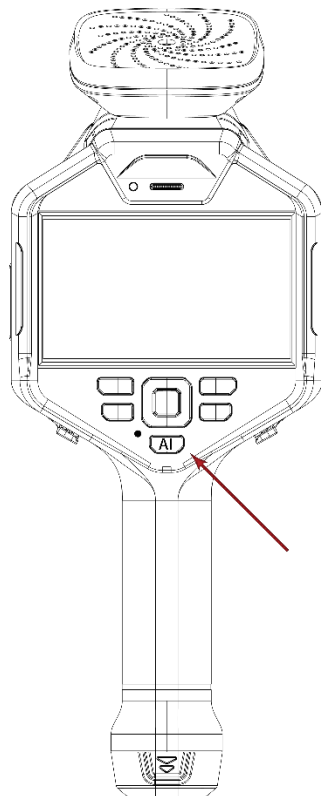

AI function operation is divided into two cases, light press operation will execute the function bound to the corresponding AI key, if the function is not bound then the default defined function will be executed. Long press AI key operation, long press > (2 seconds), then the function selection dialog box will pop up, the user can select the corresponding function to operate.

Tap the AI key to switch to the programmed function.

- Main interface AI function

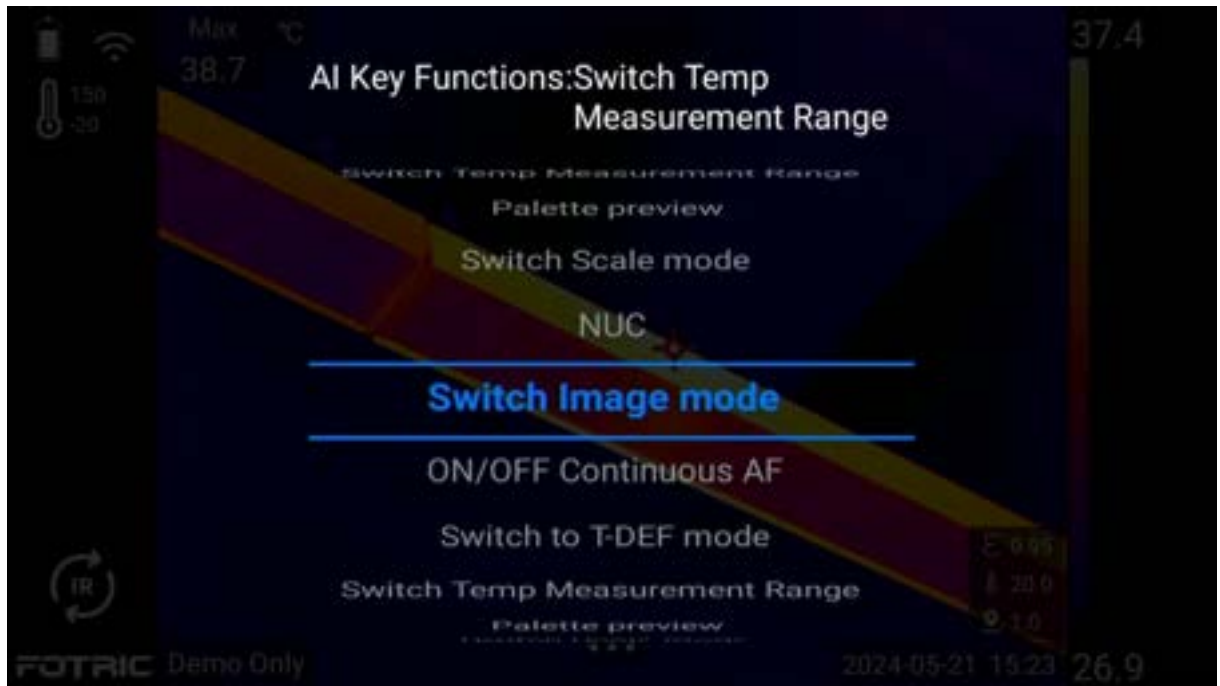

The main interface AI key function include: switching temperature range, palette preview, switching temperature span mode, NUC calibration and switching image mode.

- Freeze interface AI function

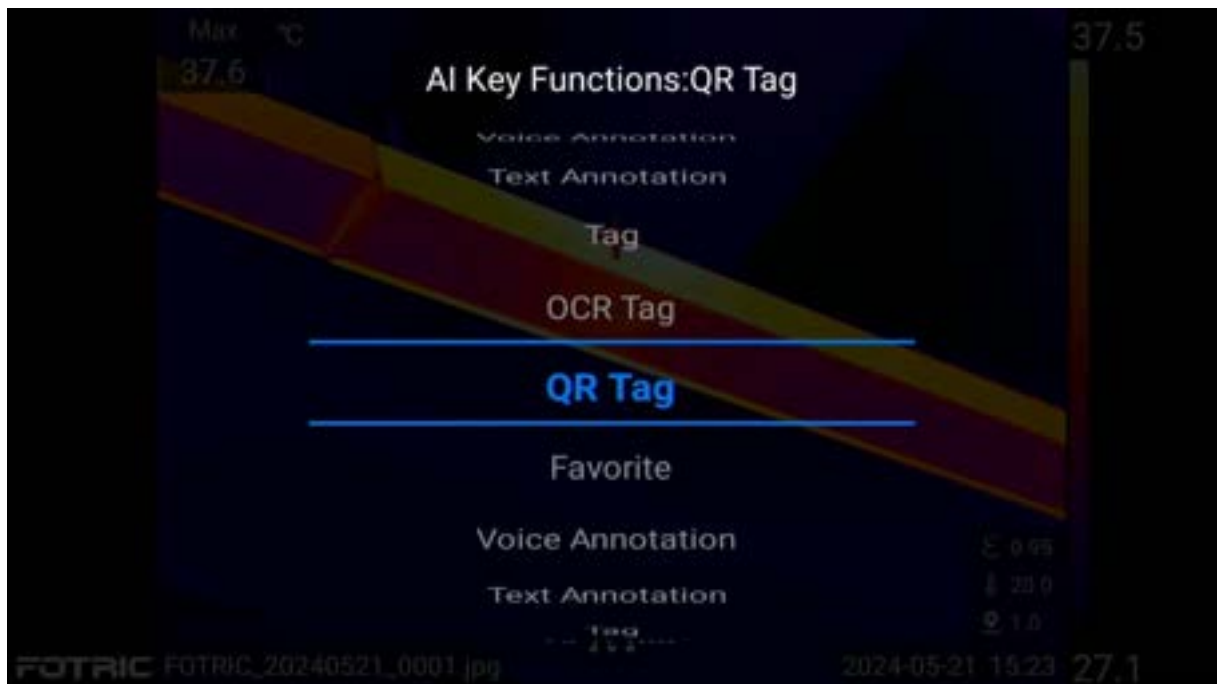

Freeze interface AI key function include: favorite, Voice Annotation, Text

Annotation, Tag and QR Tag.

- Gallery Analysis Interface AI function

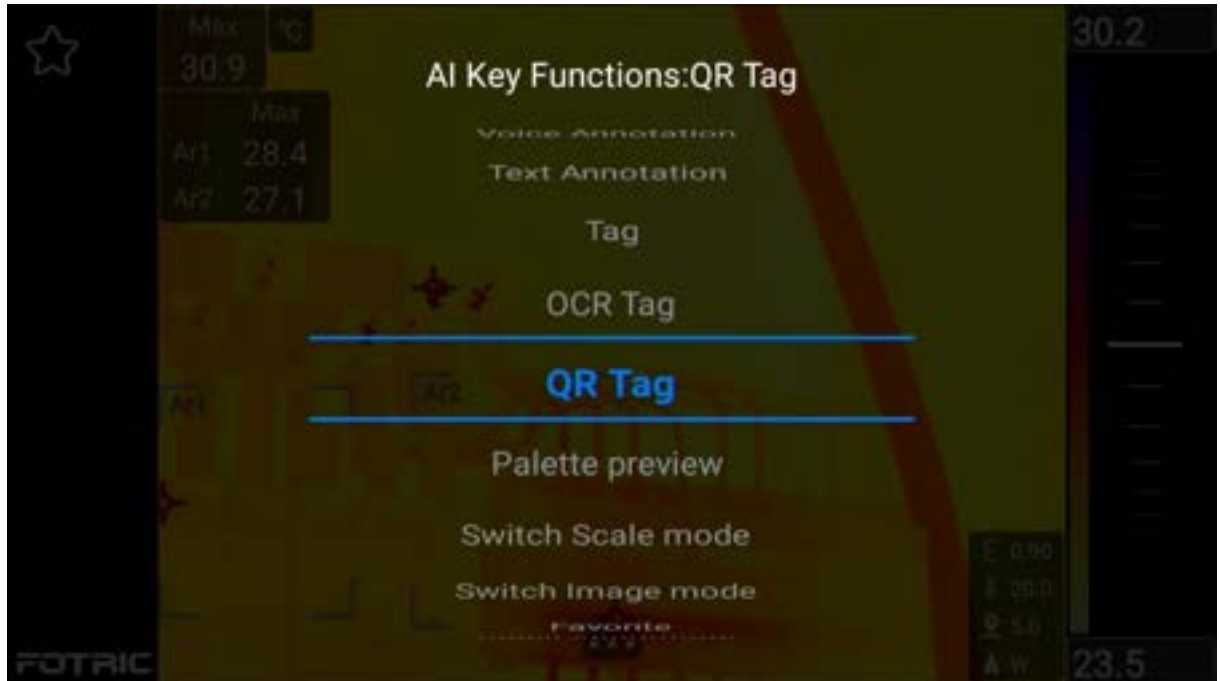

Gallery Analysis Interface AI function include: Favorite, Voice Annotation, Text Annotation, Tag, QR Tag, Palette Preview, Switch Scale mode, and Switch Image Mode.

3.13 Gallery

Press the Gallery button  on the top right of the control panel to enter the Gallery as shown below. The functions are detailed in Chapter 6 Gallery.

3.14 Calibration (NUC)

When the imager displays "Calibrating..." it is performing a thermal imaging technique called Non-Uniformity Correction (NUC).

The NUC can be executed automatically, e.g. at startup, when changing the measuring range.

To perform a manual NUC, press and hold the Gallery button for more than 2 seconds.

4 Main Interface

4.1 Thermal imaging interface

3.1.1 Overview



Figure 5-1

- 1. Status bar
- 2. Measurement result
- 3. System menu
- 4. Measurement parameters
- 5. Color palette and
- 6. Image display

Status bar on the left side, all read-only information.

Displays read-only information:

- Battery percentage: charging status can be displayed.
- Location
- Temperature measurement range
- Laser status: displayed when the laser is activated
- Date & Time
- Logo
- Warning icon for SD card low storage capacity: displayed when SD card storage is less than 100MB..

2. Measurement results

The upper left side of the center shows the results table:

- Displays the global maximum, minimum, and average values;
- Measured temperature area maximum, minimum, average, emissivity and area value/length value. The display parameters are configurable as described in 4.8.6 ROI Display Settings.

3. System menu

The bottom center  is the system button, refer to 4.4 System Menu for specific functions.

4. Measurement parameters

The lower right side of the center shows the temperature measurement parameters: emissivity, reflected temperature, ambient temperature, humidity,

temperature measurement distance and transmittance. The display status can be configured, see parameter display configuration in Setup for specific operational definitions.

5. Color palette

The right side displays the currently used palette color band and shows the upper and lower temperature width limits. This can be set in 4.5 temperature scale mode.

6. Image display

Displays: thermal, digital camera image, picture-in-picture and blend image and measurement tools. For specific configurations, please refer to Section 4.7 Image Mode.

3.1.2 Swipe-down menu



Figure 5-2

Swipe from top to bottom on the screen to pull down the system swipe-down menu. The menu mainly displays the status of the functions included in the system, and tapping the corresponding icon will turn on/off the corresponding function.



The drop-down menu contains: WiFi, Bluetooth, Flashlight, Hide Overlay, SR (Super Resolution), Volume, Brightness.

1. To open: Swipe down from the top of the screen;
2. Button control can be adjusted by click;
3. To close: Swipe up from the bottom, or click the "back" button.

3.1.2.1 Hide all overlays

Image overlay information includes measurement result table, temperature measurement parameters, ROI settings and system menu button.

Overlay information can be "hidden" in swipe-down menu.

	
<p>Display overlay information</p>	<p>Hide overlay information</p>

3.1.3 Real-time digital zoom

The real time image and video can be scaled using the digital zoom function of the acoutherm imager.



Operating Procedures

- Zoom in: Touch the screen with two fingers and spread the fingers apart.
- Zoom out: Touch the screen with two fingers and pinch the fingers together.





3.1.4 System menu



Click system menu button  to open, includes: Temperature scale mode, Measurement parameters, Image mode, ROI, Palette, and Settings.

-  Temperature scale mode: auto scale, manual scale, touch-screen scale;
-  Measurement parameters: emissivity, reflection temperature, ambient temperature, relative humidity, temperature measurement

distance, IR window compensation;

- c)  Image modes: thermal image, digital camera image, picture-in-picture, blend(T-DEF);
- d)  ROI temperature measurement tools: Spot, Rectangle, Temperature Rise, Delete, Display Settings, More Settings (Line, Circle, Selection);
- e)  Palette: The first row displays the common color palettes Iron, Grey, RainBow, Rain, Medical, GreyRed, and the second row displays Above Alarm Temperature, Below Alarm Temperature, Alarm Temperature Interval;
- f)  Settings: capture mode, temperature measurement range, storage & save options, and device set.

3.1.4.1 Temperature scale mode

 is the temperature scale mode button.

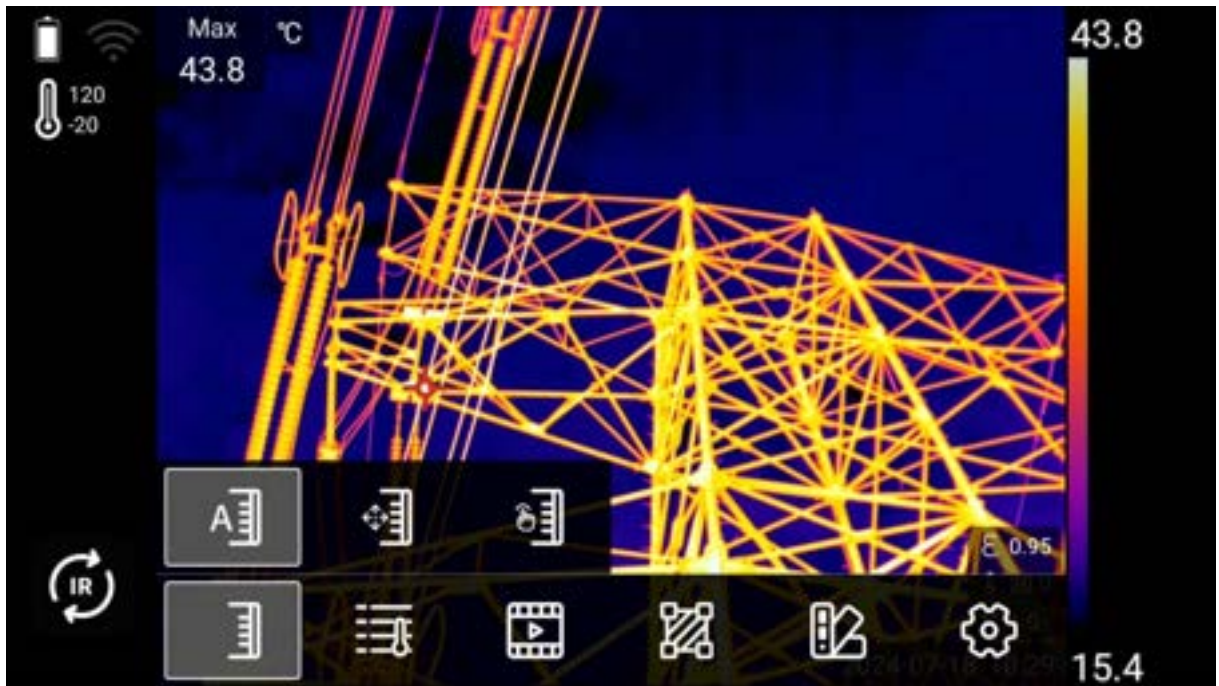

The acoutherm imager supports  auto scale,  manual scale and

 touch-screen scale modes.

Auto scale mode

 In Auto Scale Mode, the upper and lower temperature scale limits can be automatically adjusted to achieve the best image effect.

In TWB mode, they are the highest and lowest of the histogram range, not the on-screen.

Manual scale mode

 In Manual Scale Mode, the upper and lower limits of temperature scale limits can be set manually. Manual scale has two options, and can be set in Settings-Device Set- manual mode.

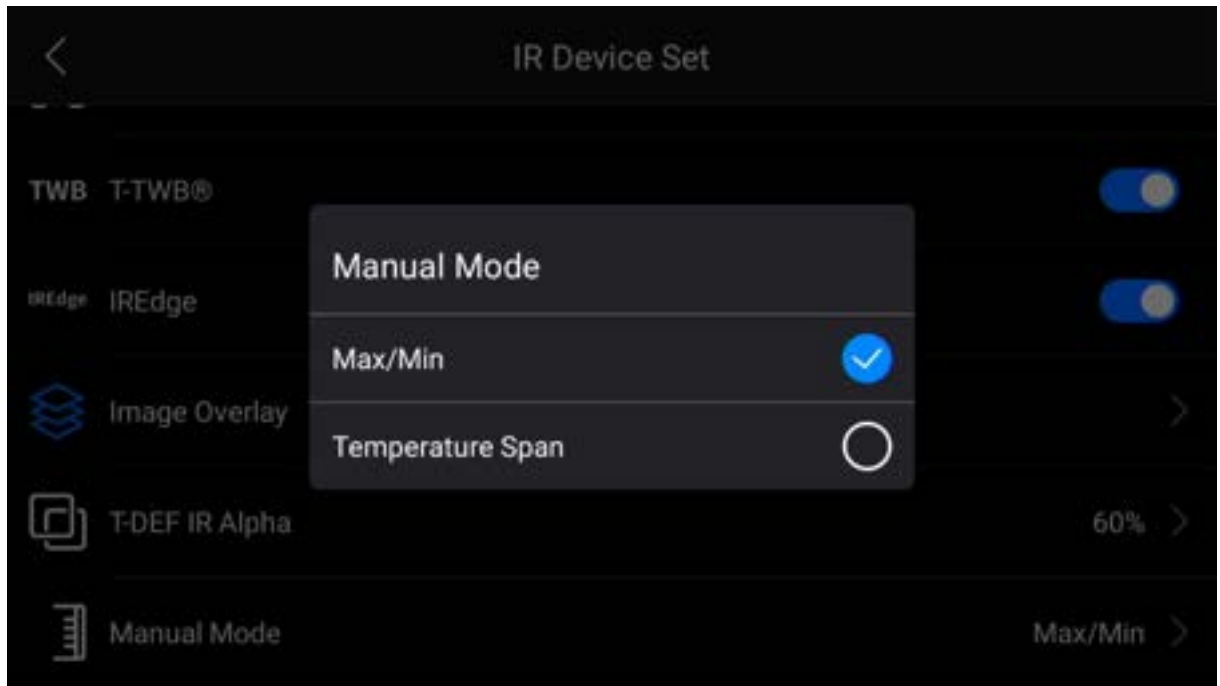

Max/Min mode

Manual Adjustment Mode is set to Maximum/Minimum, which allows users to adjust the upper and lower limits of the temperature width separately.

1. After selecting the manual temperature width, click on the upper and lower values of the temperature span to lock the span. The background will turn gray, indicating it's locked;

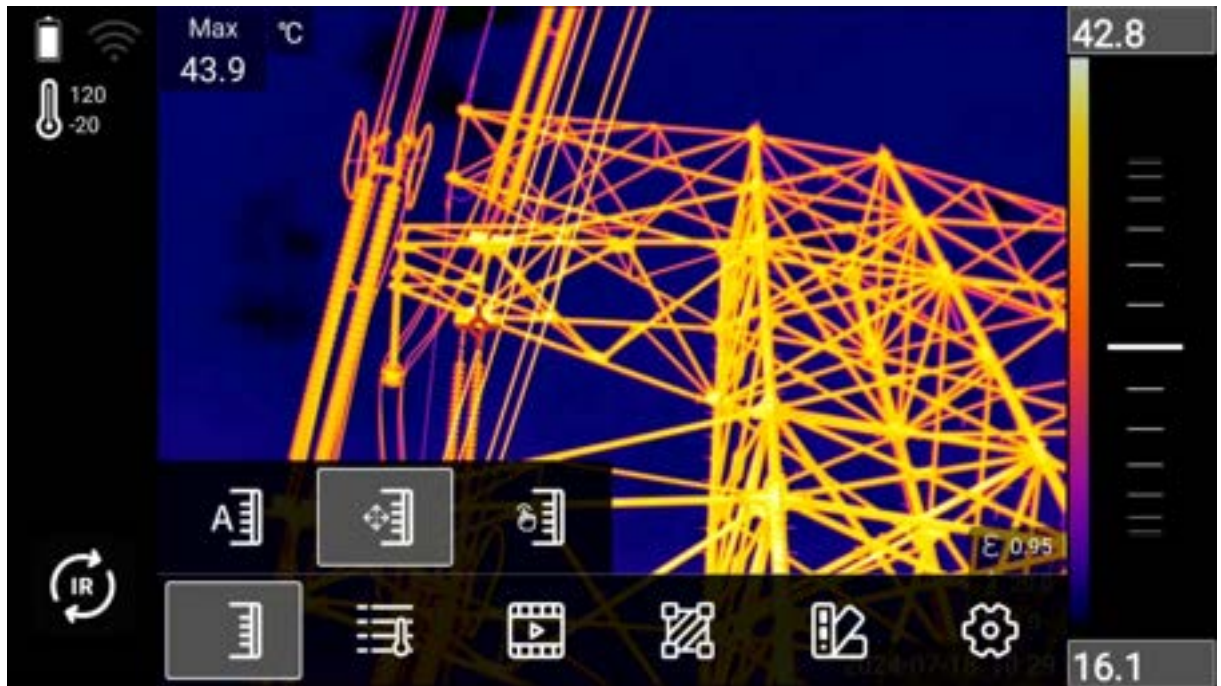

2. Slide the wheel up and down or press the up and down arrow keys to adjust the upper and lower limit values of the temperature width in the selected state.

Slide the pulley as shown below to adjust the upper and lower temperature width limits simultaneously:

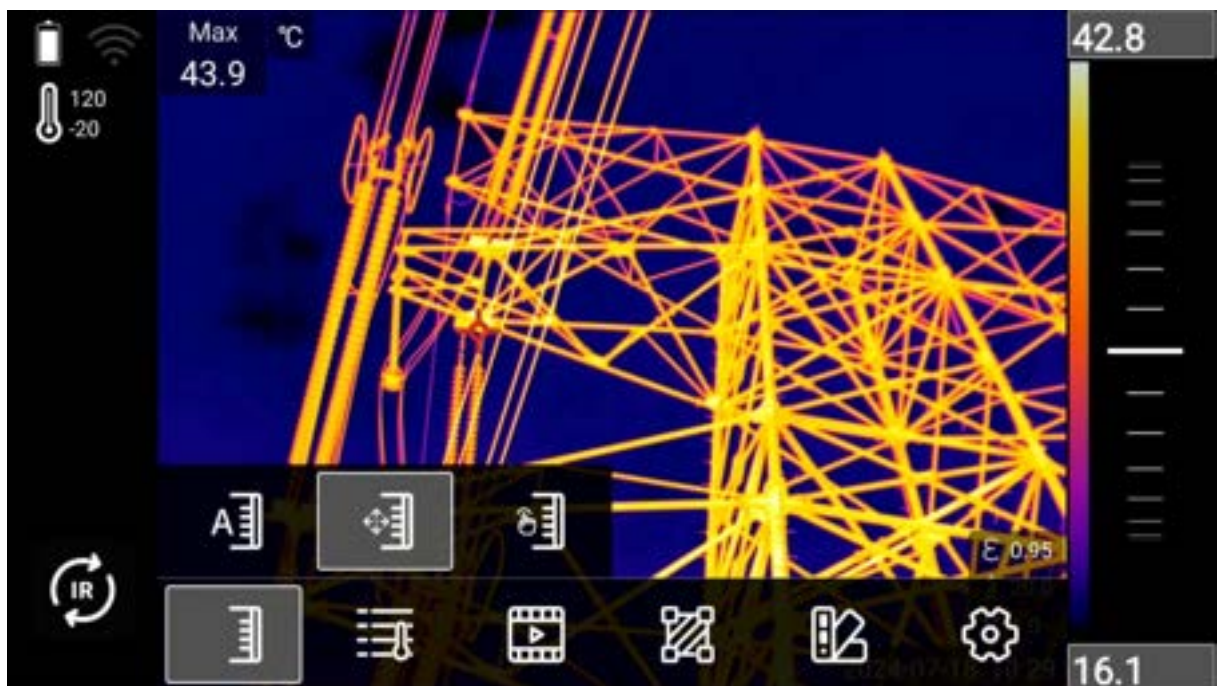

Slide the pulley as shown below to adjust the lower limit value of temperature width:

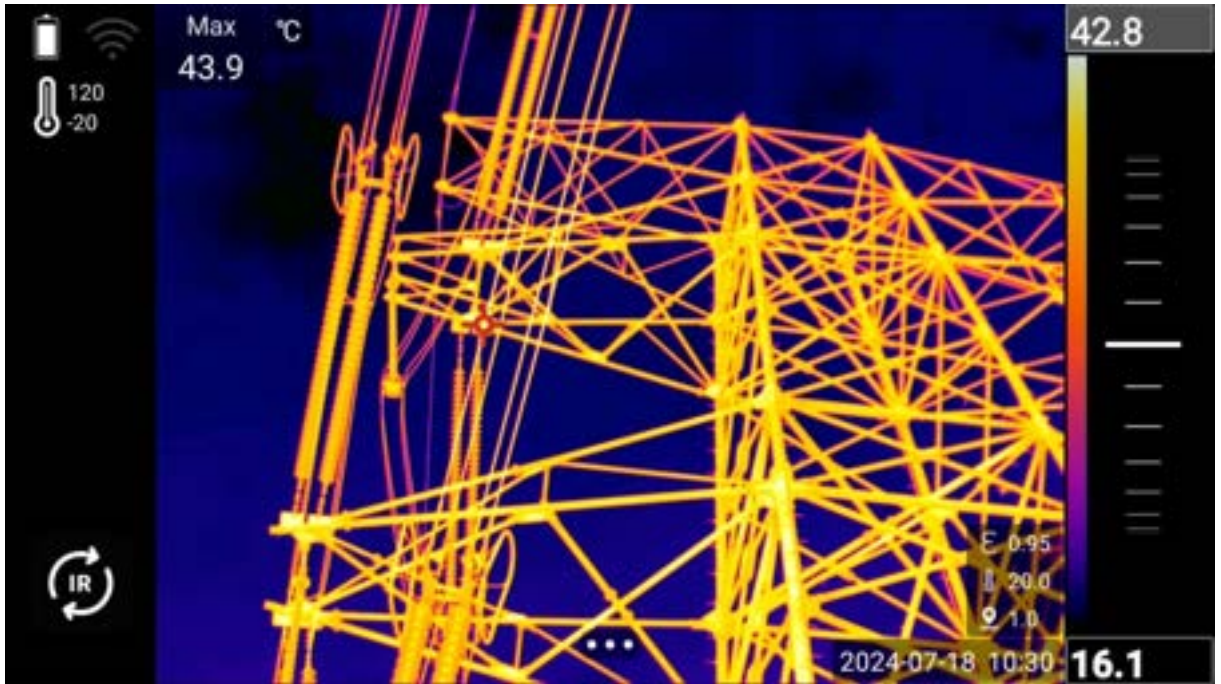

Slide the pulley as shown below to adjust the upper limit value of temperature width:



As shown below the upper and lower temperature width limits are in a locked

state and are not adjustable:

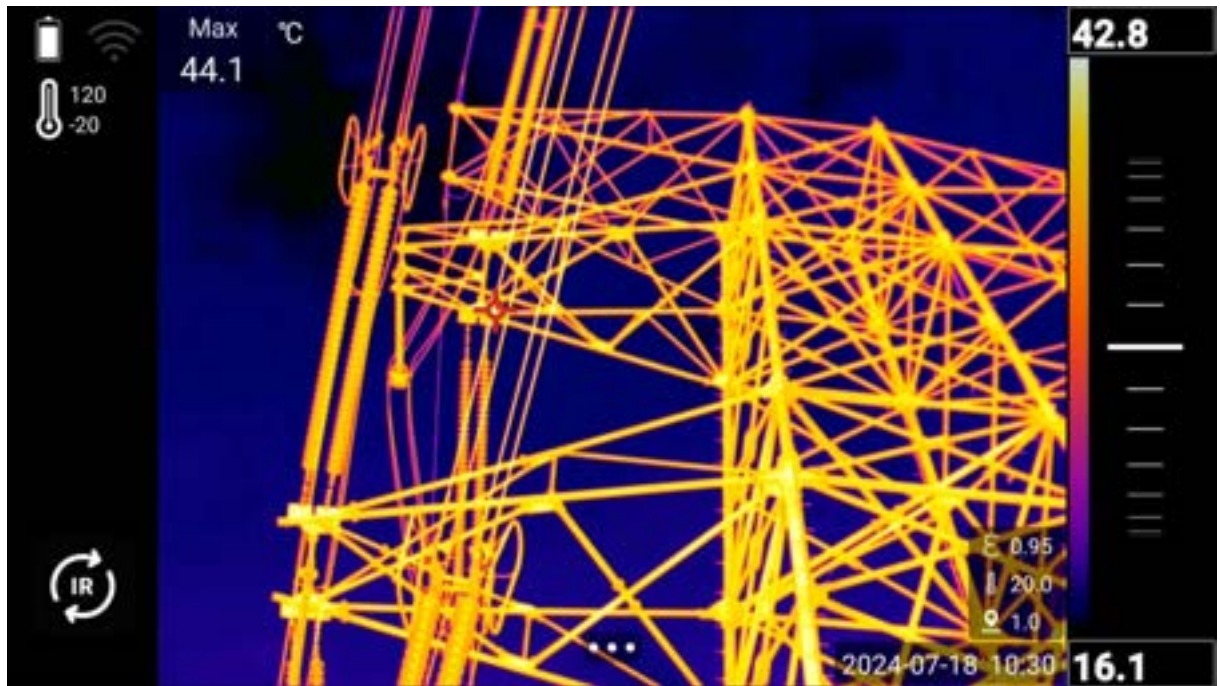

Temperature and width mode

Select the temperature width mode, when manually adjusting the temperature width slide wheel or press the direction key can only adjust the upper and lower limits of the temperature width at the same time, the temperature width (difference between the upper and lower limits) value stays unchanged at a fixed value, as shown in the following figure:



- At this point, the upper and lower temperature width limits cannot be selected individually, but can only be adjusted at the same time;
- Press the left and right arrow keys to adjust the temperature width value



Touch-screen scale mode



In Touch-screen scale mode, the upper and lower temperature scale limits can be adjusted automatically by touching the screen based on temperature range of the touch area (about 10 x 10 pixels in size).

Touch scale mode has two options like manual scale mode.

1. In Maximum/Minimum value mode, the temperature scale can be adjusted by selecting the upper and lower limits of the temperature scale. (If gray base is selected,

refer to manual mode).

2. In Temperature span mode, the upper and lower limits of the temperature scale can only be adjusted at the same time, not separately. Press the left and right direction keys to adjust the temperature scale range.

3.1.4.2 Measurement parameters

 is the temperature measurement parameter button, which allows users to adjust the temperature measurement parameters of the acoutherm imager.



Emissivity

Emissivity is the ratio of the energy radiated outward by the object being measured to the energy radiated by a blackbody at the same temperature and wavelength, with a value between 0 and 1.

! Note: The emissivity of a material is one of the most important parameters that

affects the ability of an acoutherm imager to accurately measure the temperature of the object under test.



ε This icon is the emissivity setting button.

The emissivity settings of the FOTRIC acoutherm imager are categorized into two types: full-screen emissivity correction and zonal emissivity correction.

For full-screen emissivity correction, please follow the steps below:

1. Click the Emission Rate Setting button;
2. To customize the material emissivity, users can slide the emissivity value (0.01-1.0) up and down on the left side of the screen;
3. If the material of the DUT is known, the material emissivity reference table on the right side of the screen can be slid up and down (to select the appropriate material);
4. For unknown material emissivities, refer to the material emissivity tables under this

manual to find them;

5. If this is also not recorded in the Material Emissivity table under this operation manual, please refer to the text description of how to set the emissivity of the acoutherm imager in this manual for instructions.

! Note: For partition emissivity correction, please refer to this manual for ROI partition setting emissivity.

Reflected temperature

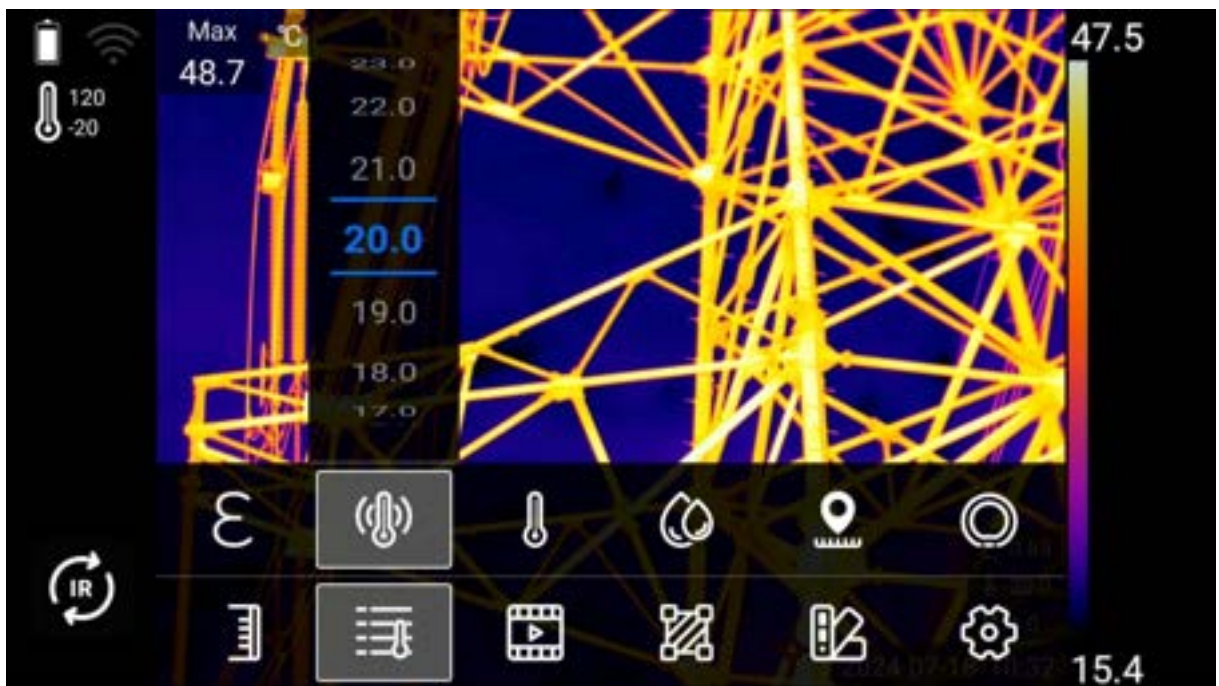

Reflected temperature is used to compensate or correct for thermal radiation reflected on the target being measured.

If the emissivity of the target to be measured is low and the actual temperature is much lower relative to the temperature of its reflective source, it is important to set this parameter correctly and compensate for the reflected temperature for accurate

temperature measurement.



This icon is the reflected temperature setting button.

To set the reflection temperature, perform the following steps:

1. The actual temperature of the reflective source near the target is first tested with an acoutherm imager;
2. Click the Reflective Temperature Setting button;
3. Slide the screen up and down to set the reflected temperature value to the actual temperature value of the reflected source measured by the acoutherm imager;
4. Setting the reflection temperature can be accomplished by clicking on other areas of the thermal image screen, or by clicking on the Exit button.

! Note: If on-site testing conditions allow, avoiding reflective interference as much as possible can dramatically improve measurement accuracy.

Ambient temperature

The ambient temperature is the temperature of the air between the acoutherm imager and the target object.

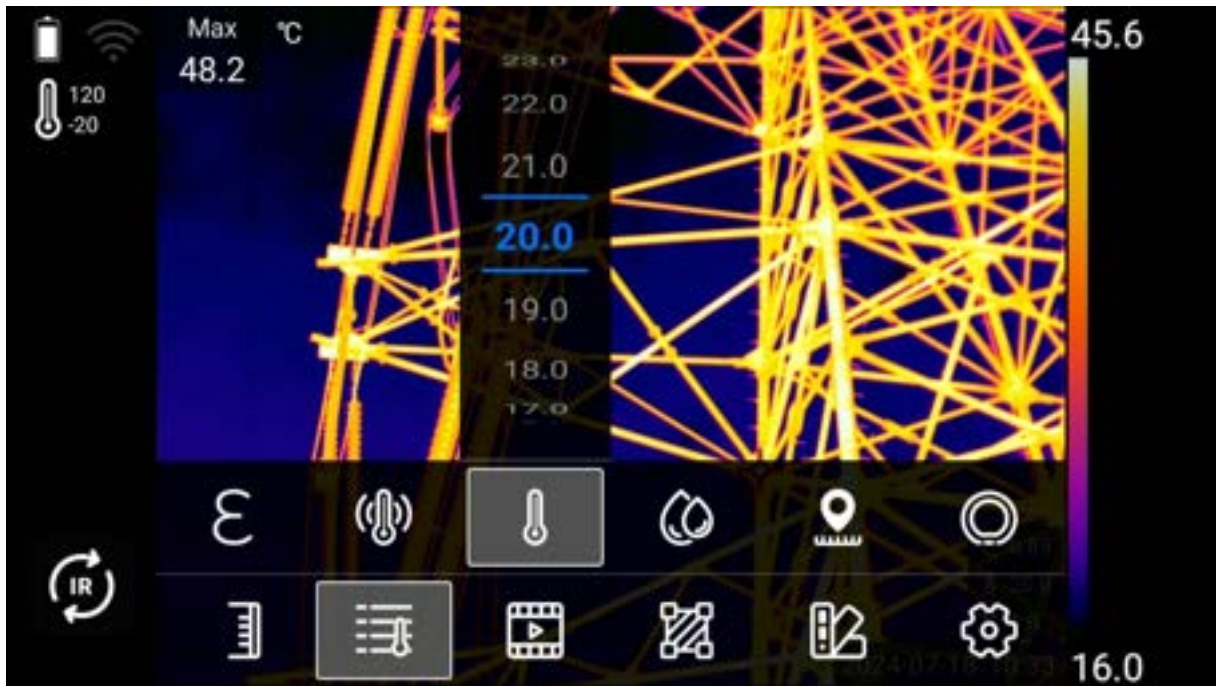

This icon is the ambient temperature setting button.

To set the ambient temperature, please perform the following steps:

1. Click the Ambient Temperature Setting button;
2. According to the actual air temperature in the test scenario, slide the ambient temperature value of the screen up and down to set the ambient temperature value to the actual air temperature value;
3. Setting the ambient temperature can be accomplished by clicking on other areas of the thermal image screen, or by clicking on the Exit button.

! Note: The value of the ambient temperature is usually the system default, and the parameter needs to be set only if the atmospheric temperature is higher than the actual temperature of the target to be measured.

Relative humidity

The acoustic thermography compensates for the localized effects of the relative humidity of the air on the transmission of thermal radiation. Therefore, please set the relative humidity to the correct value.

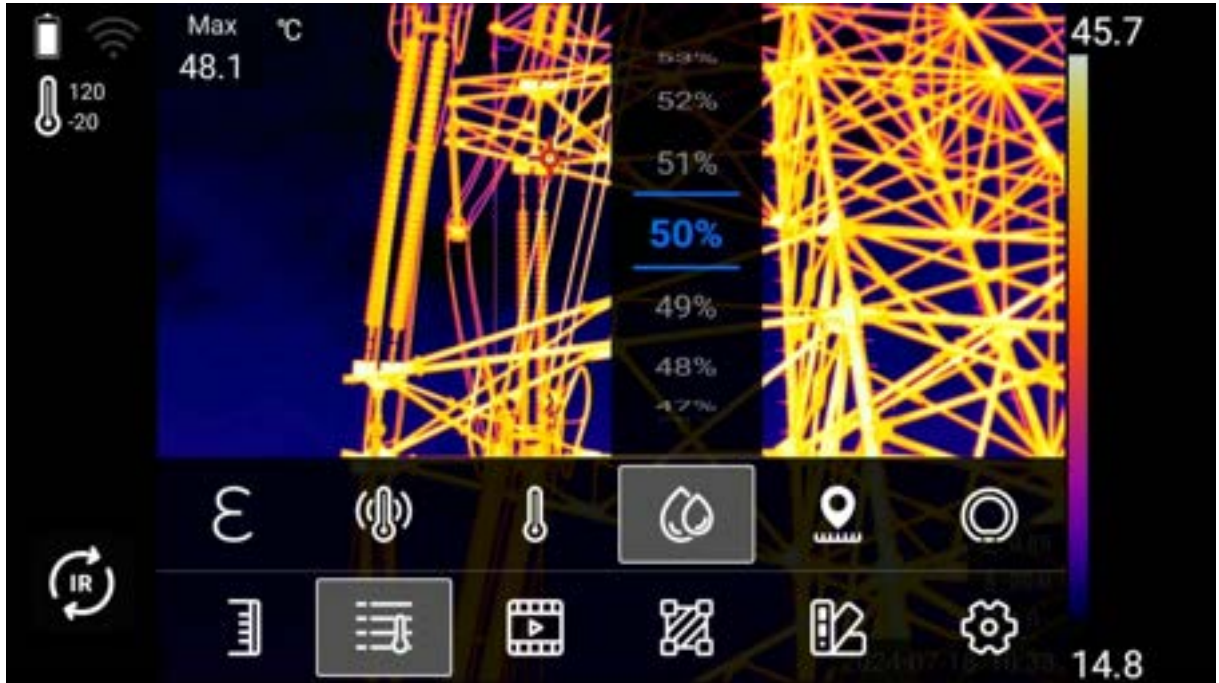

This icon is the relative humidity setting button.

To set the relative humidity, please perform the following steps:

1. Click the Relative Humidity Setting button;
2. According to the relative humidity in the test scenario, slide up and down the screen to set the relative humidity percentage value to the actual value;
3. Click on other areas of the thermal image screen, or click on the Exit button to complete the RH settings.

! Note: At short distances and normal humidity, the relative humidity is usually set to the default value for infrared acoutherm imagers.

Distance

The measurement distance refers to the distance between the measured target and the lens of the acoutherm imager. This parameter is used to compensate for the following two situations:

- Thermal radiation absorbed by the atmosphere between the target and the lens of the acoutherm imager in the thermal radiation from the target under test;
- Thermal radiation coming from the atmosphere itself and detected by an acoutherm imager.

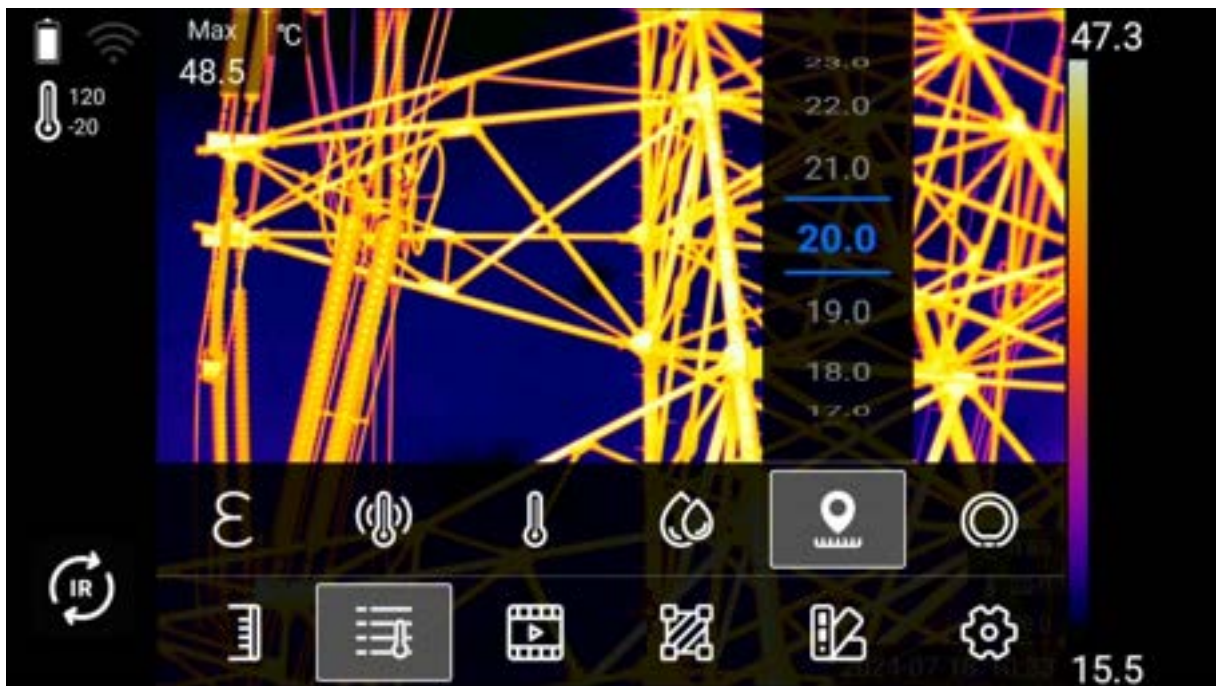

This icon is the measuring distance setting button.

To set the measurement distance, please perform the following steps:

1. Click the Measurement Distance Setting button;
2. Based on the actual distance between the target under test and the infrared

acoutherm imager lens, slide the distance value on the screen up and down to set the distance value to the actual value;

3. Click on other areas of the thermal image screen or click on the Exit button to complete the setting of the measurement distance.

External optical parameters

IR window compensation is used to correct the transmittance and temperature of the external optical material used in front of the lens of the acoutherm imager.

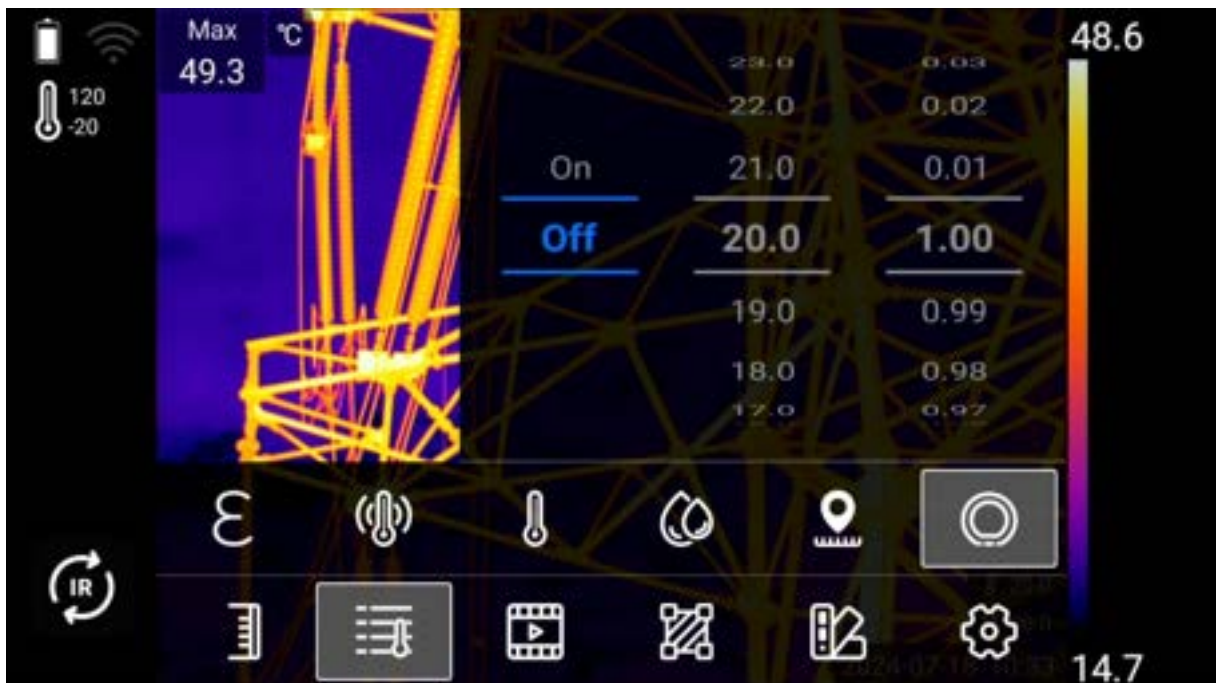

This icon is the IR window compensation setting button.

To set up IR window compensation, please perform the following steps:

1. Measurement of the actual transmittance of the external lens or external IR window, (usually carried out by FOTRIC's after-sales service department or by a qualified partner authorized by FOTRIC, accurate testing requires the use of a measurement standard source);

2. Click the IR Window Compensation Settings button;
3. Slide the screen up and down to select on;
4. Select the temperature of the external optical window/lens according to the actual situation;
5. Set the transmittance to the actual value by sliding the transmittance value (0.01-1.0) on the screen up and down according to the actual transmittance measured;
6. Set the external optical transmittance by clicking on other areas of the thermal image screen, or by clicking on the Exit button.

! Note: If the optional external optics have been calibrated at the factory, or if there is no external IR window, the IR window compensation is usually set to off.

Recommended values

Emissivity	0.95
Reflected temperature	20°C
Ambient temperature	20°C
Relative humidity	50%
Distance	1.0 m
Infrared window compensation /External optical properties	closed

3.1.4.2 Image mode

The image modes of acoustic thermography can be categorized into thermal, visible light, picture-in-picture, and visible light thermometry modes.

Click the  (Image Mode) button to bring up the Image Mode submenu.

Thermal image mode

 This icon is the thermal image mode button: displays an infrared image.



! Note: In thermal image mode, please make sure that the infrared acoutherm imager is accurately focused. If the infrared thermal image is not clearly focused, it will affect the accuracy of the acoutherm imager's temperature measurement.

Digital camera image mode

 Visible light mode: Displays the visible light image of the digital camera.

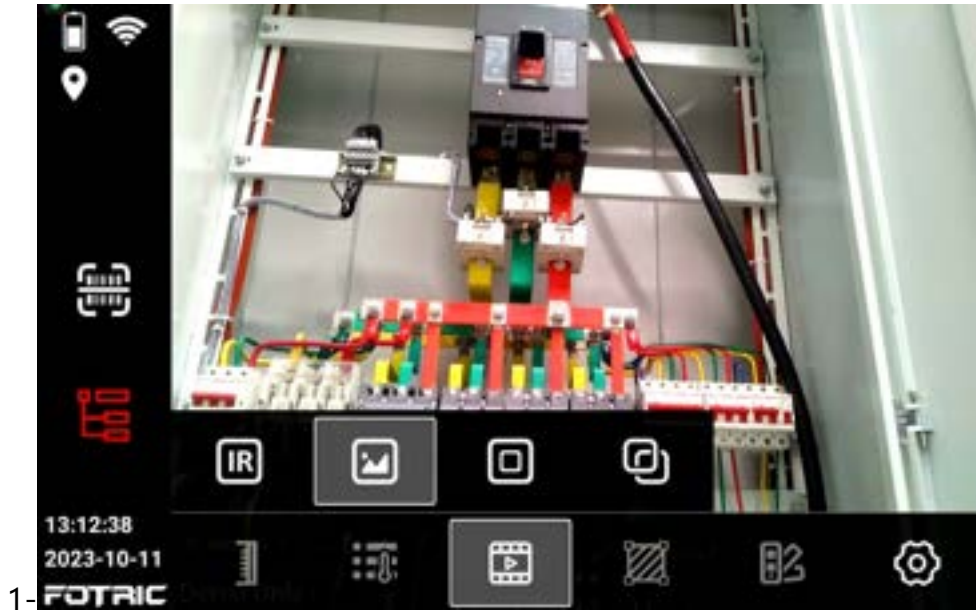

Picture-in-picture mode



Picture-in-Picture Mode: Infrared thermal images are displayed

superimposed on visible digital photographs.



2-When focusing the acoutherm imager automatically adjusts the position of the thermal image to automatically match the visible light.

3-Click on the edge of the thermal image screen to select the thermal image, as shown below:

1. Click and drag the corners to adjust the thermal image coverage;
2. Click and drag on the center of the thermal image to adjust the position of the thermal image.

! Note: In picture-in-picture mode, please make sure that the infrared acoutherm imager is accurately focused, if the infrared thermal image is not clearly focused, it will affect the accuracy of the acoutherm imager's temperature measurement, and also when the visible light does not match the thermal image.

T-DEF® blend mode



Visible light thermometry mode: Visible light is fused with the thermal image

to enhance the display of target details.



Thermal and visible images are automatically matched when focusing.

The transparency of the thermal image can be adjusted by means of a pulley underneath, and in full transparency the temperature markers and temperature data

can be displayed directly on the visible light.

If the transparency is adjusted to 0% for use, it is recommended to turn on the continuous focus function to ensure that the image overlaps and focuses sharply.

! Note: In visible light temperature measurement mode, please make sure that the infrared acoutherm imager is accurately focused. If the infrared thermal image is not clearly focused, it will affect the accuracy of the acoutherm imager's temperature measurement, and at the same time, there will be a mismatch between the visible light and the thermal image image screen.

3.1.4.4 ROI measurement tools



This icon is the temperature measurement tool selection button. Click on the Measurement Tool Selection button to enter the Measurement Tool submenu.

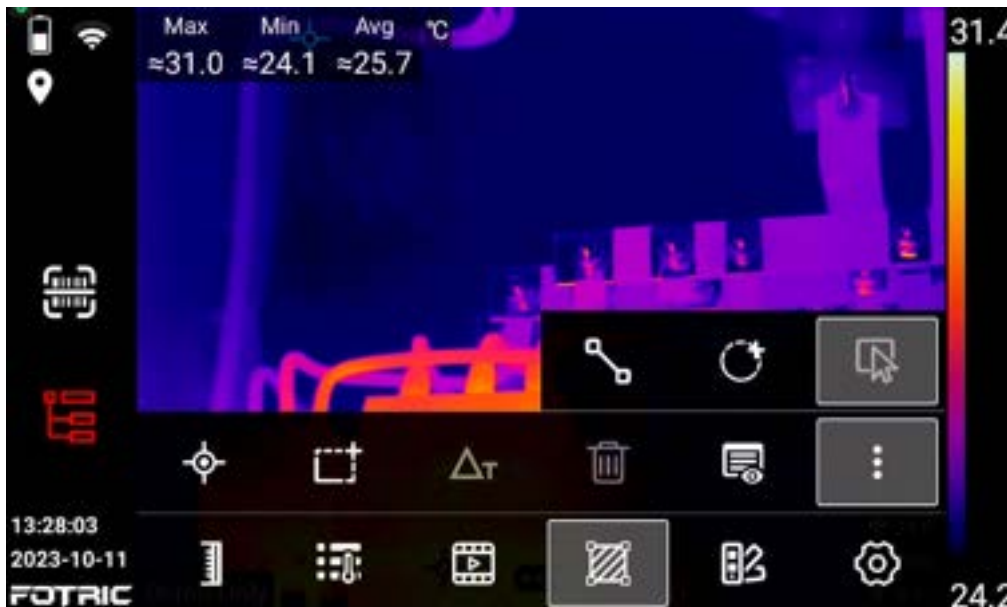



This icon is a moveable point measurement button, click this button to increase the point measurement area;



This icon is a movable rectangular area measurement button, click this button to increase the rectangular measurement area;



This icon is the inter-phase temperature difference calculation button, click on this button to set the temperature difference calculation between the temperature measurement marks or the temperature difference calculation between the measurement marks and the fixed temperature;



This icon is the button to delete all ROIs with one click;



This icon is the button for the ROI display settings;



This icon is the More button, click it to show more function buttons;



This icon is a movable linear area measurement button, click this button to increase the linear measurement area;



This icon is a movable circular area measurement button, click this button to increase the circular measurement area;



This icon is the ROI selection button.

ROI is an acronym for region of interest;

ROI can be set for circular measurement area, rectangular measurement area, linear measurement area, and point measurement;

Circular measurement areas have the name prefix Ci; rectangular measurement areas have the name prefix Ar;

The name prefix for linear measurement areas is Li; the name prefix for point measurements is Sp.

Select ROI

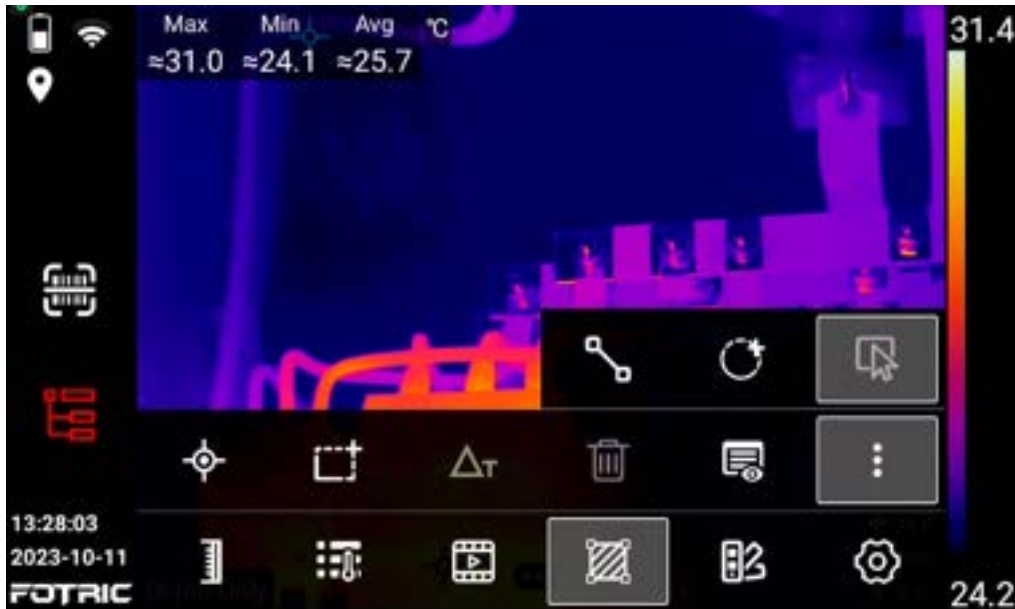

To to select ROI, please perform the following steps:

1. Click directly on the ROI to be selected on the screen;
2. Or click the ROI selection button and the ROI will be displayed on the left side of the screen;
3. Press in the ROI selection area of the screen and press up and down or swipe up and down to select the ROI that needs to be adjusted;
4. Users can choose to move the ROI position, adjust the ROI profile size, and the firing rate according to their measurement needs;
5. Click on other areas of the screen, or click on the Exit button to complete the ROI selection.

Adjustment of ROI

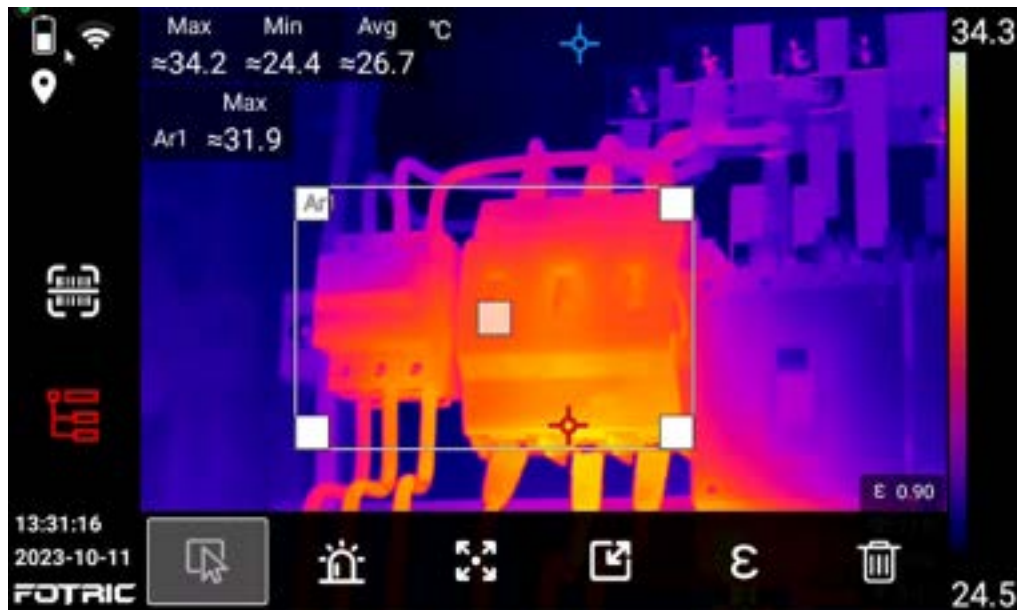

 This icon is the ROI selection button;

 This icon is an audible alarm button;

 This icon is the button to move the ROI position;

 This icon is the button to resize the ROI outline;

 This icon is the button to set the emissivity for the ROI partition;

 This icon is the button to delete the ROI.

To to adjust the selected ROI, please should perform the following procedure:

1. Check ROI;
2. Select the ROI on the touch screen where the audible alarm needs to be set, and click the Alarm Setting button to set the high or low temperature alarm according to the highest or lowest temperature of the area, see the Audible Alarm Function in this manual for details;
3. Tap the button to move the ROI, press the four arrow keys on the top right of the screen to move the ROI, or press and hold the ROI on the touch screen to move it

to the desired location;

4. Tap the button to resize the ROI profile, and lightly press the four arrow keys "up, down, left, right" at the top right of the screen of the acoutherm imager to resize the ROI profile, or directly press and hold the ROI profile that needs to be resized on the touch screen (just press one of the four rectangles on the ROI profile), and slide it up, down, left, right, or left on the touch screen to resize the ROI profile; the ROI profile can be resized by clicking on it. Slide up, down, left and right on the touch screen to adjust the size of the ROI contour;
5. Select the ROI of the emissivity that needs to be adjusted on the touch screen, click the button of ROI partition setting emissivity, the customized interface of emissivity value and emissivity material table will appear on the screen. Customize the value of emissivity or directly call the value in the emissivity material table, refer to this manual ROI partition setting emissivity in detail;
6. After completing the ROI setting, click on the blank position of the screen image or click on the Exit button to complete the ROI adjustment setting.



Delete ROI

There are two ways to delete ROIs: delete selected ROIs and delete all ROIs.

Delete selected ROIs



To remove the selected ROI, do the following:

1. Tap directly on the touch screen on the ROI that needs to be deleted (e.g. Ar1);
2. Clicking on  at the bottom of the screen displays the button icon for deleting the ROI  ;
3. Click on the button icon  for deleting ROIs to directly delete the selected ROI (e.g. Ar1); and
4. The screen shows that the selected ROI has been deleted (e.g., Ar1).

Delete all ROIs

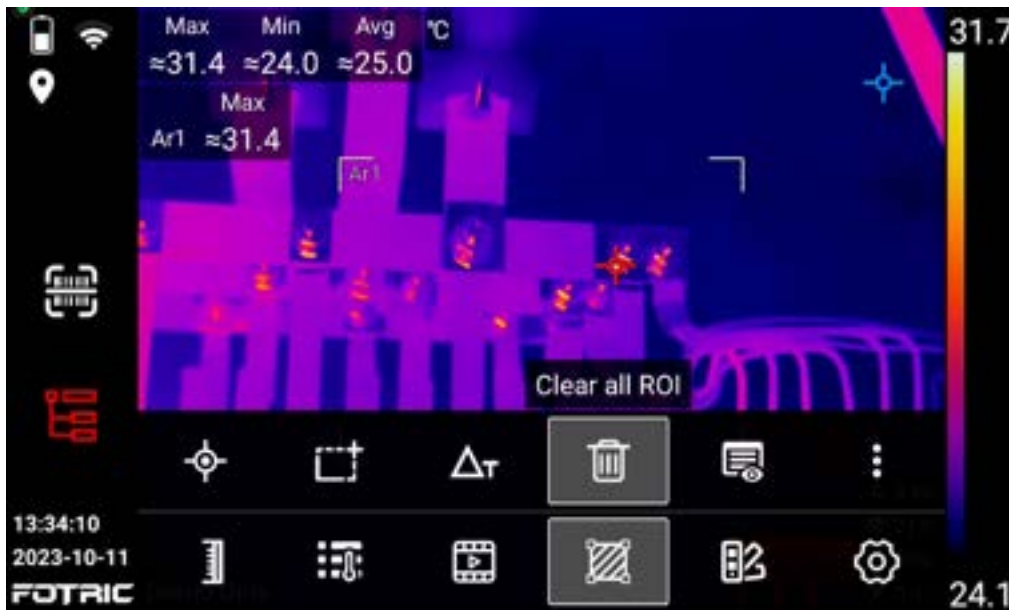

To delete all ROIs, do the following:

1. On the touchscreen tap the System Menu button at the bottom of the screen;
2. Tap the Measurement Tools button that appears at the bottom of the screen;
3. The Measurement Tools submenu appears at the bottom of the screen;
4. Click the Delete button within the Measurement Tools submenu;
5. Remove all ROI information from the screen with one click.

ROI emissivity

 This icon is the button to set the emissivity for the ROI.

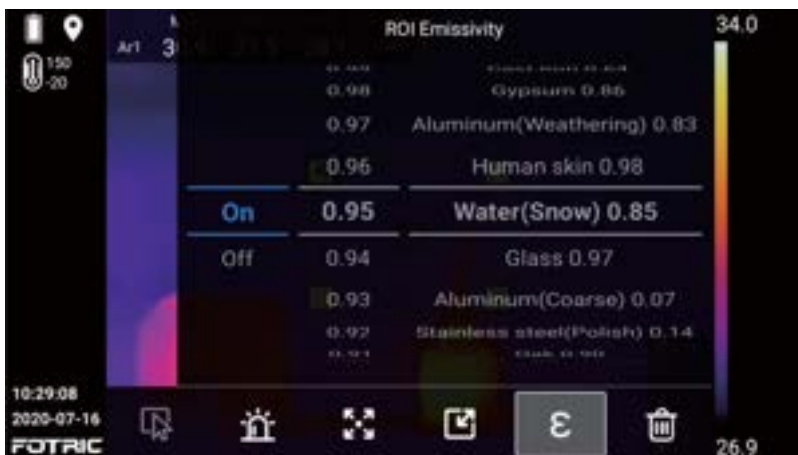



To set the emissivity for an ROI, perform the following procedure:

1. Click the ROI that requires partial emissivity setting.
2. Click the emissivity button.
3. Slide up and down to set the emissivity value (0.01 – 1.0), or choose the material type.
4. If the materials type is not found on screen, please refer to the material Emissivity Table in the end of this manual. If the material type is not in the material emissivity table or unknown, please contact FOTRIC on how to set it.
5. After the ROI partial emissivity set, click the other area of the screen or click the back button to complete.

! Note: If the material emissivity is also not recorded in the table of material emissivities under this operation manual, please refer to the text description of how to set the emissivity of the material acoustic thermography.

ROI display settings



ROI display set button

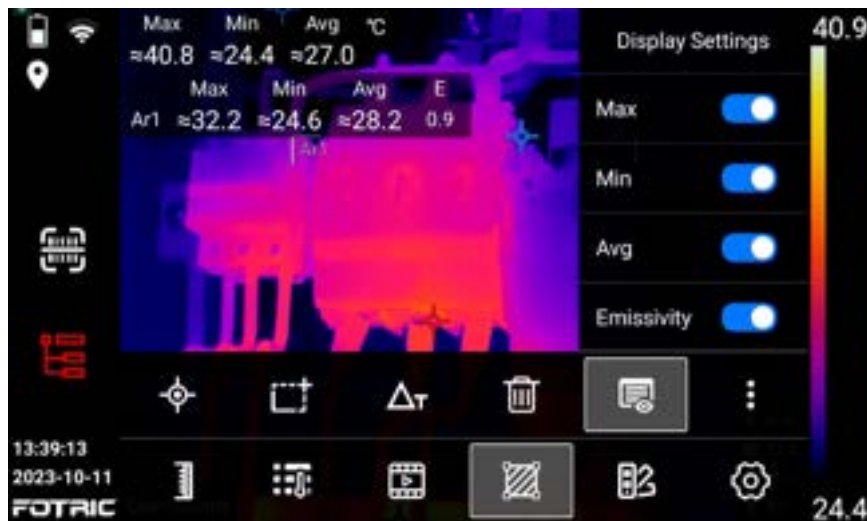

ROI information can be set to display on screen, including maximum, minimum, average temperature and emissivity.

Temperature difference calculation



This icon is the thermometry ROI identification temperature difference calculation button.



1. Click to set the temperature difference between the temperature measurement ROIs, or the temperature rise between the ROI and a reference temperature value.
2. For the temperature rise between the ROI and a reference temperature,- the temperature displayed on the screen is the actual temperature minus the reference temperature, which can be used to eliminate environmental interference and calculate the temperature change

Alarm

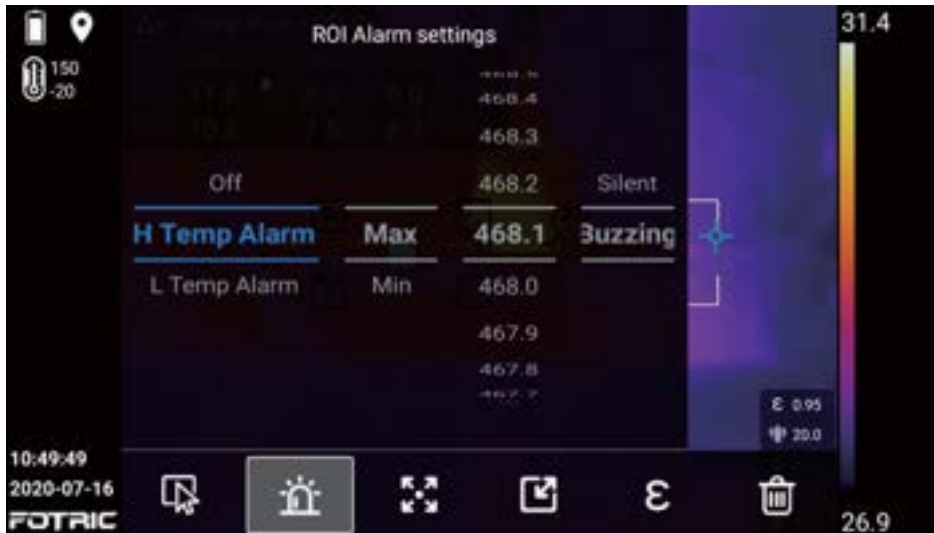

This icon is the audible alarm setting button.

High temperature alarm: When the designed temperature is higher than the preset high temperature threshold, the temperature value will turn red, and a sharp rapid beep sound can be set triggered to remind.

Low temperature alarm: When the designed temperature is lower than the preset low temperature threshold, the temperature value will turn blue, and a sharp and intermittent beep sound can be set triggered to remind.

Highest temperature: alarm is given for the highest temperature of ROI ;

Lowest temperature: alarm is given to the lowest temperature of ROI ;

To turn on the sound alarm, please perform the following steps:

1. Select the alarm area; (different alarms can be set for different ROIs).

2. Click  button at the bottom of the screen and select the sound alarm button.
3. Choose high temperature alarm or low temperature alarm as required.
4. Set maximum or minimum temperature in the region.
5. In the temperature alarm bar on the screen, slide up and down to adjust the temperature threshold.
6. Click the other areas of the screen, or click the back button to complete the sound alarm setting.

3.1.4.5 Palette



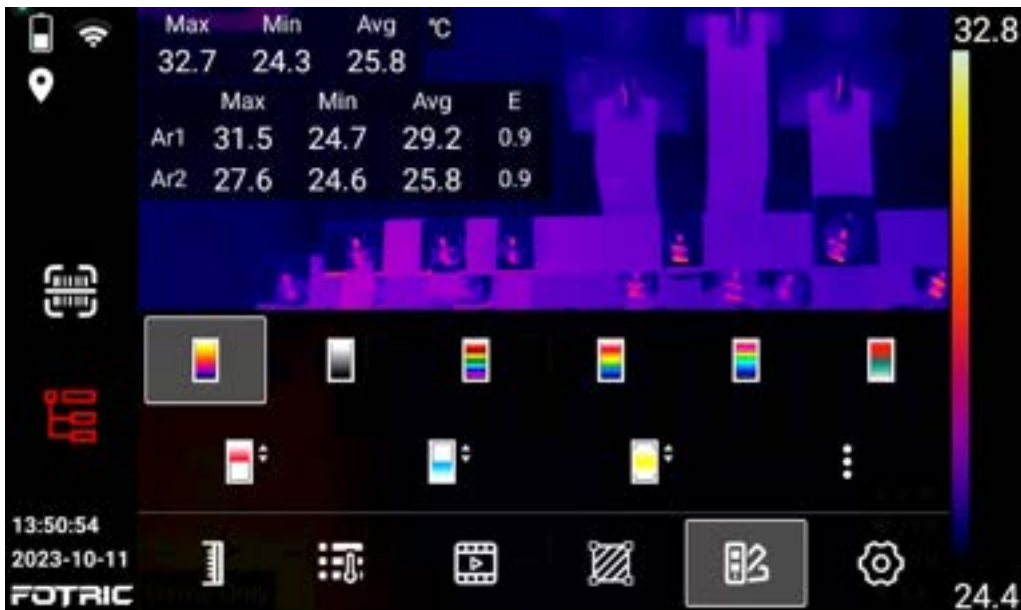

Click the Palette Setting button to enter the Palette Quick Switch submenu, which allows users to select a color palette and set color alarms (isotherms).





 This button is for the Iron Red palette mode;

 This button is for black and white mode;

 This button is rainbow mode;

 This button is for spring rain mode;

 This button is the medical mode;

 This button is in red and gray mode;

 This button is a color alarm above the temperature (isotherm) and is generally used for quick screening of temperature anomalies in the area of the target being measured;

 This button is a color alarm (isotherm) below the temperature and is generally used for quick screening of temperature anomalous areas of the target under test;



This button is a color alarm (isotherm) between temperatures and is generally used for quick screening of temperature anomalous areas of the target under test;



This button is the Composite Palette Rainbow mode;



This button is for the Composite Palette Iron Red mode;



This button is a hidden button for more functions, as shown below:

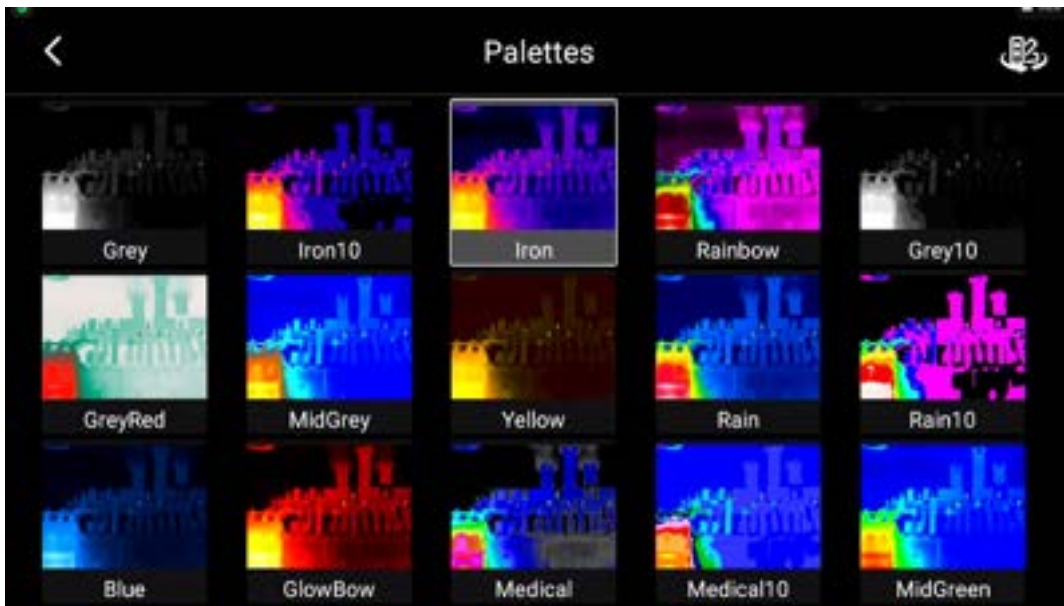

Invert the color button for the palette, invert it and click on the desired palette to switch directly to the selected palette.

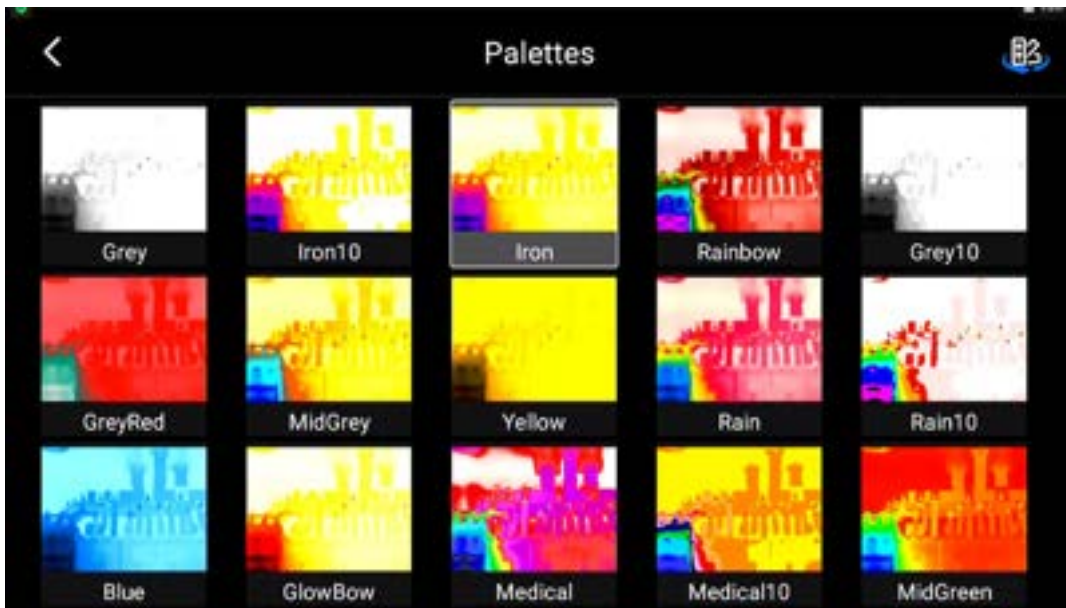

Color alarm (isotherm)

Isotherms are generally used to quickly screen for areas of temperature anomalies in the target under test. This acoutherm imager supports three types of isotherms, above temperature, below temperature, and between temperature.



This button is a color alarm above the temperature (isotherm) and is generally used for quick screening of temperature anomalies in the area of the target being measured;



This button is a color alarm (isotherm) below the temperature and is generally used for quick screening of temperature anomalous areas of the target under test;



This button is a color alarm (isotherm) between temperatures and is generally used for quick screening of temperature anomalous areas of the target under test.



1. High temperature color alarm



4-Select temperature above for color alarm, users can select the value in the upper right corner, and adjust the value by pressing up and down buttons after it becomes blue.

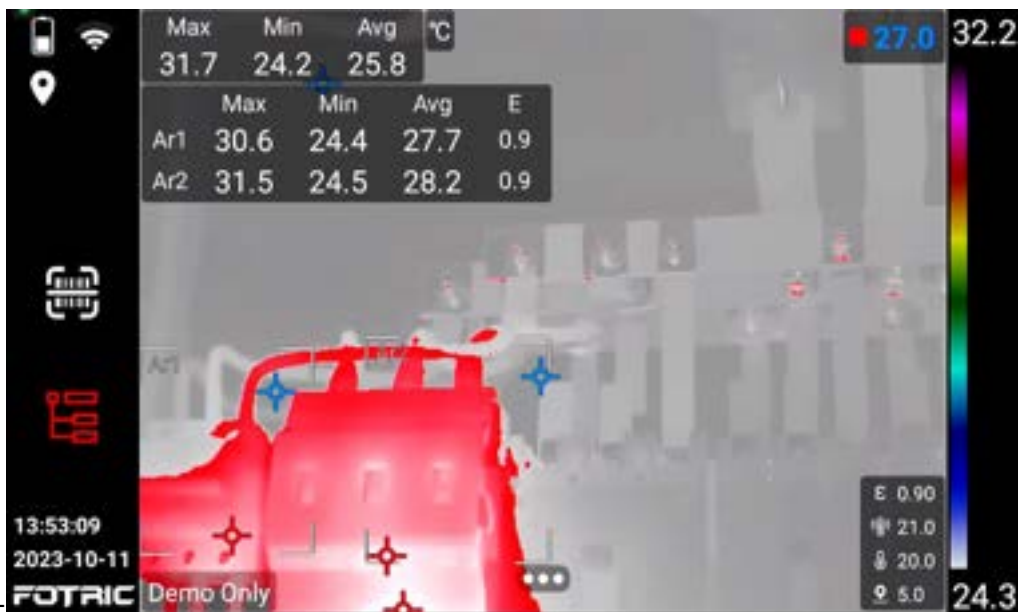

2. Low temperature color alarm



Select temperature under for color alarm, user can select the value in the

upper right corner, after it becomes blue, adjust the value by up and down buttons.

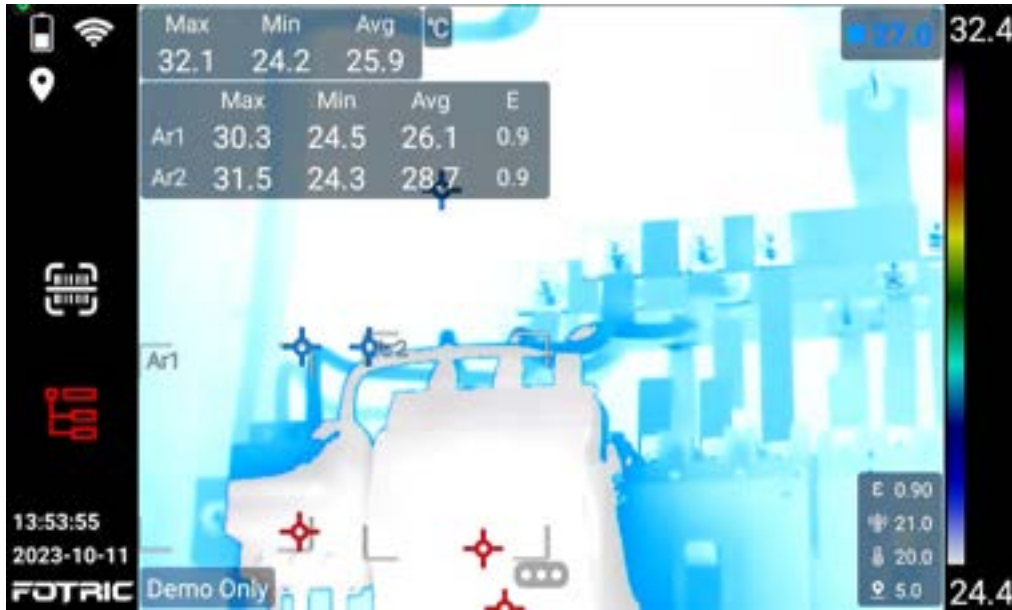

3. Interval temperature alarm

Select  temperature between for color alarms.

The alarm between temperatures can be set separately for the lower and upper limits, and can be adjusted for values that turn blue by pressing the up and down buttons to modify the values.



4.2 Acoustic Imaging Interface

3.2.1 Overview

4.3

2 Diagnostic result

1 Status bar

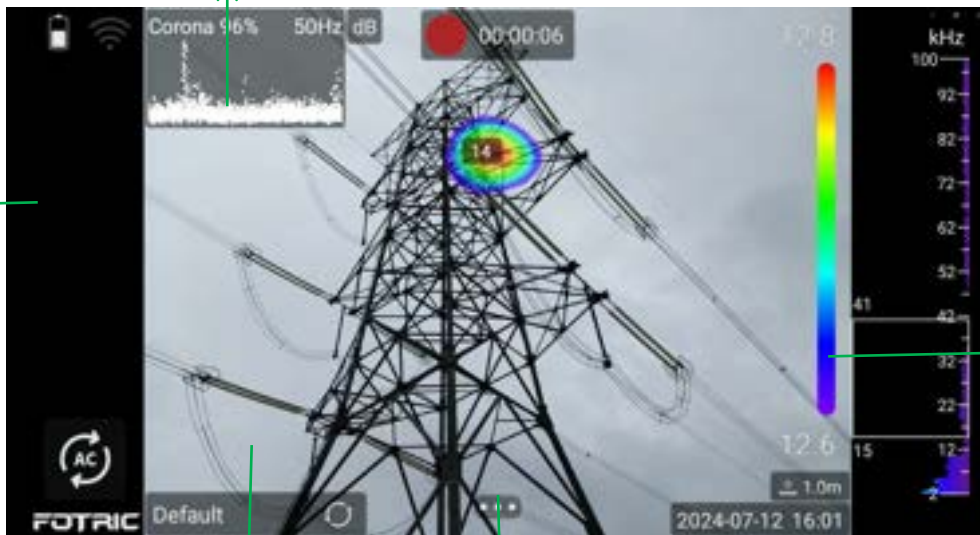

4 Palette, frequency spectrum.

5 Image display

3 System menu

3.2.1.1 Status bar

Status bar on the left side, all read-only information. Contains: logo, time, battery, Bluetooth, WiFi, compass, current temperature range, SD card capacity low reminder icon and more.

Description:

Top position: battery, memory warning (displayed when SD card capacity is less than 100MB), Bluetooth headset, laser status display (displayed when the laser is illuminated, otherwise it is not displayed), WiFi, current temperature range;

Bottom position: logo.

Display Instructions:

- LOGO;
- Time: Displays the full date and time in the format: 2019-04-19 12:00:00;
- Battery: Battery level is indicated by an icon. Charging status can be displayed;
- SD Card Capacity Low Warning Icon: The icon is displayed when the SD card storage is below 100MB;
- Laser status icon: When the laser is activated, the icon is displayed and vice versa;
- Bluetooth headset, showing that the Bluetooth headset is connected;
- WIFI icon, this icon is displayed when WIFI is on, otherwise it is not displayed;

3.2.1.2. Diagnostic result

The top left corner is the **diagnostic result**, all read-only information. Contains: PRPD chart, diagnostic type, severity, AC frequency, distance, global units (dB),

compass, leakage, leakage level, cost, and more.

3.2.1.3 System menu



Includes: acoustic parameters, focus mode, measurement tool, palettes, detection mode, settings

Acoustic parameters

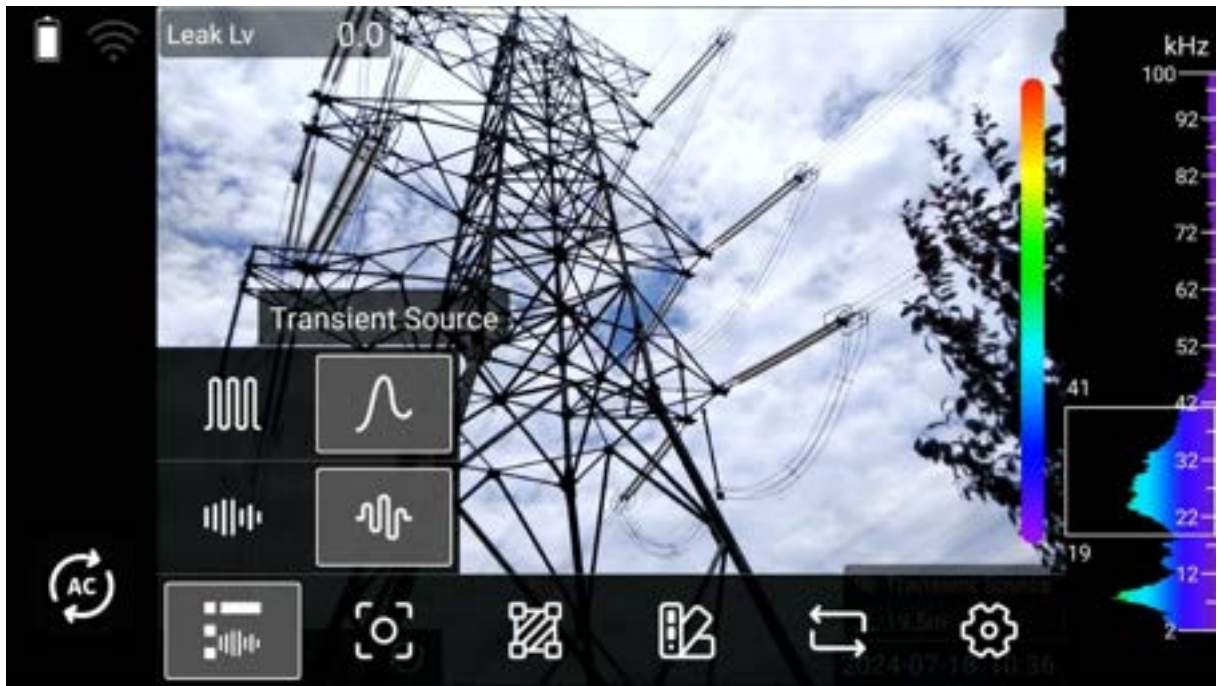

1. Sound source modes: single source, multi-source, and hologram; For detailed illustrations, please refer to section 5.2.1

2. T-FFTD (signal linger mode): steady source, transient source.

Steady source mode is the default mode, the camera display will response promptly when the signal appears or fades away.

Transient source mode will extrapolate the presence of signals to make sure even transient signals will linger long enough to grasp the user' s attention.

Acoustic image focus

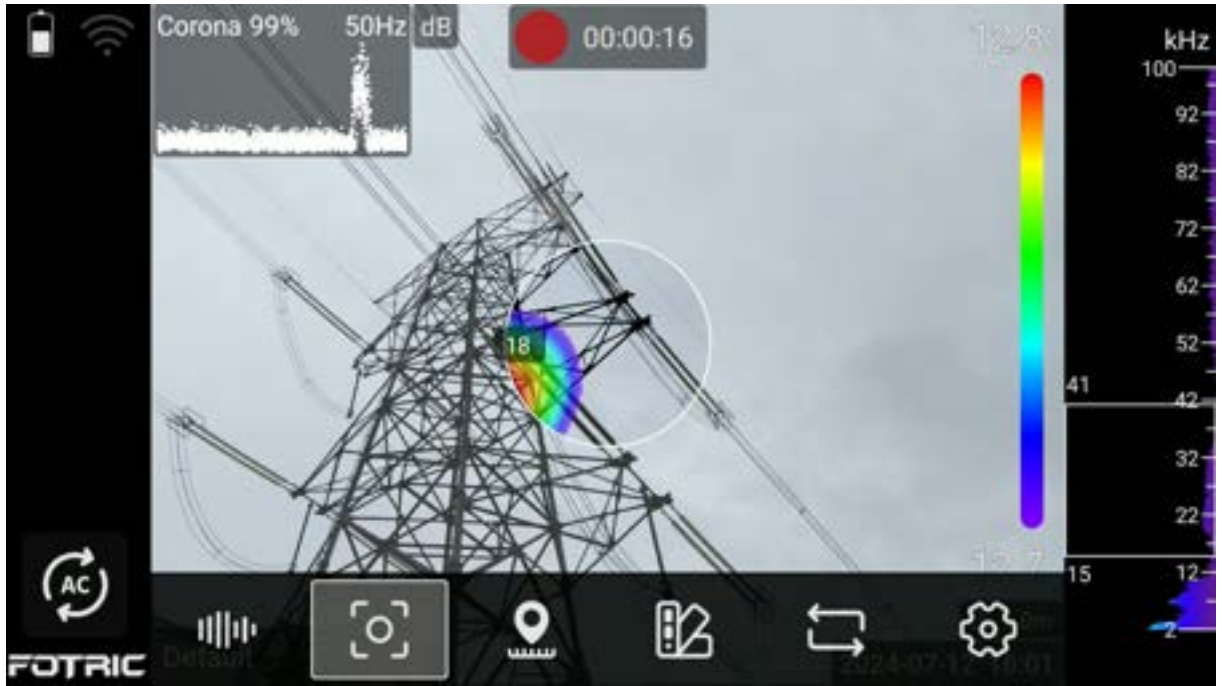

Focus Mode: Turn on Focus Mode and the sound image screen will only detect sound sources within the focus frame;

Measurement tools



Measurement tools include: apply spot and circle, set distance.

Palette



Palette: red-blue, iron-red, gray-white, more (grayscale, transparency)

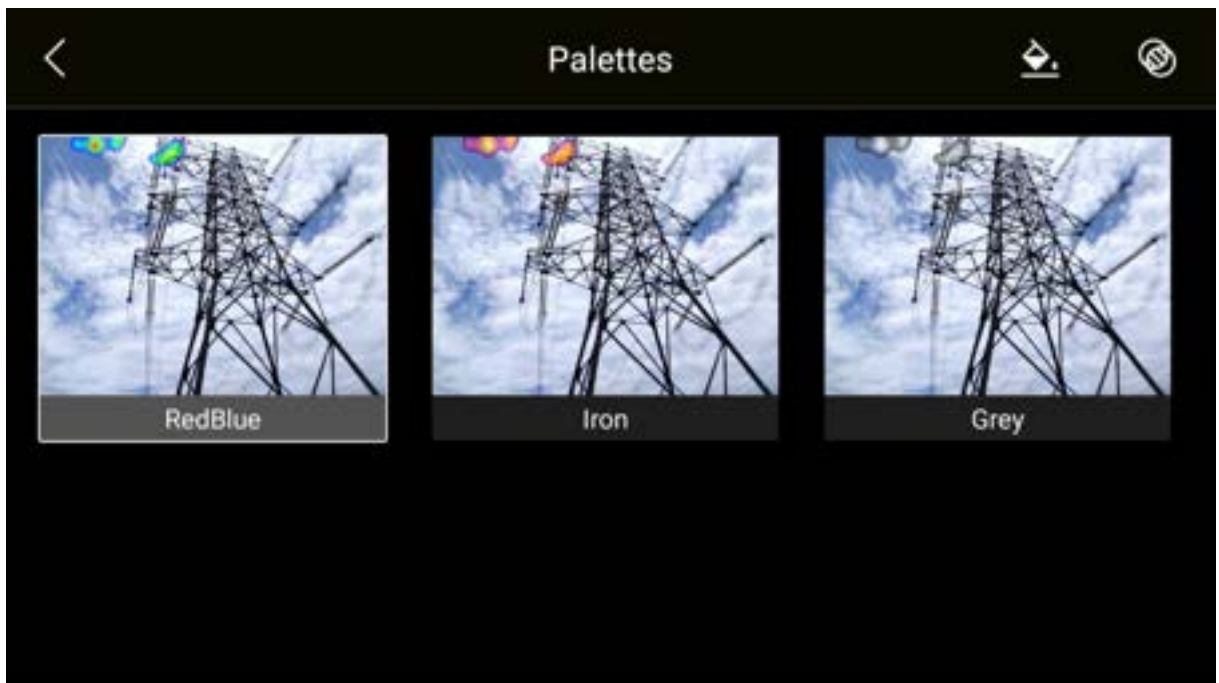

Gray scale: off

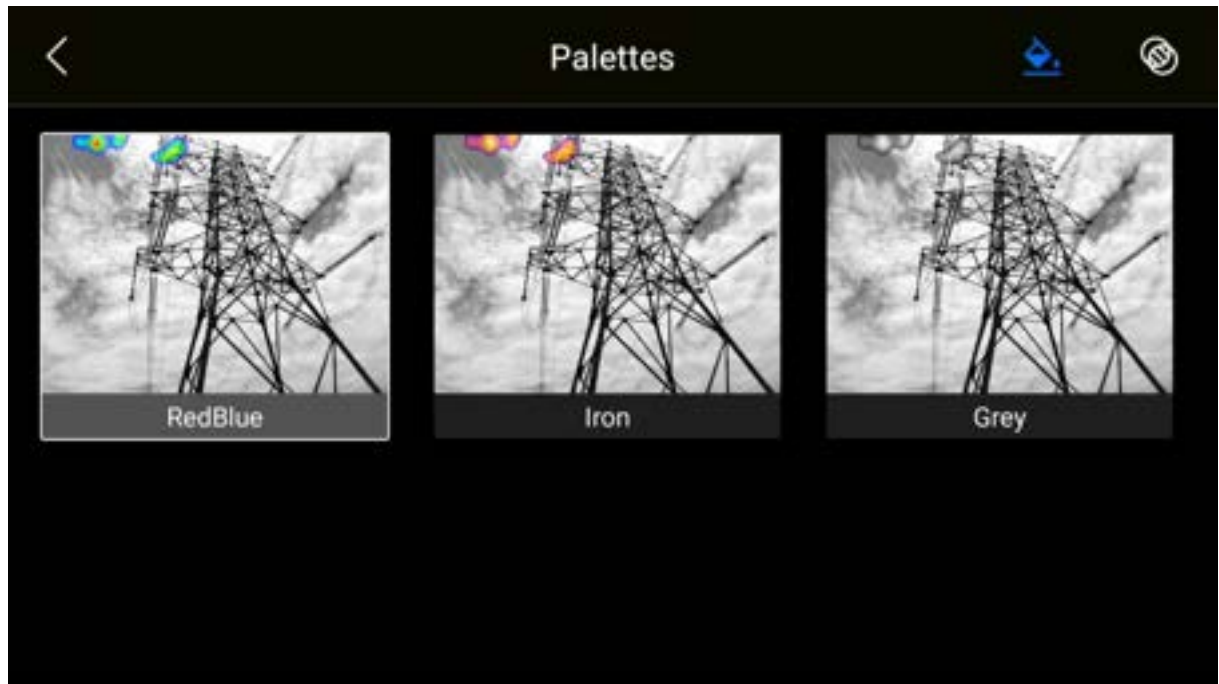

Gray scale: on

Detection mode

Detection mode include:

Partial discharge detection mode:

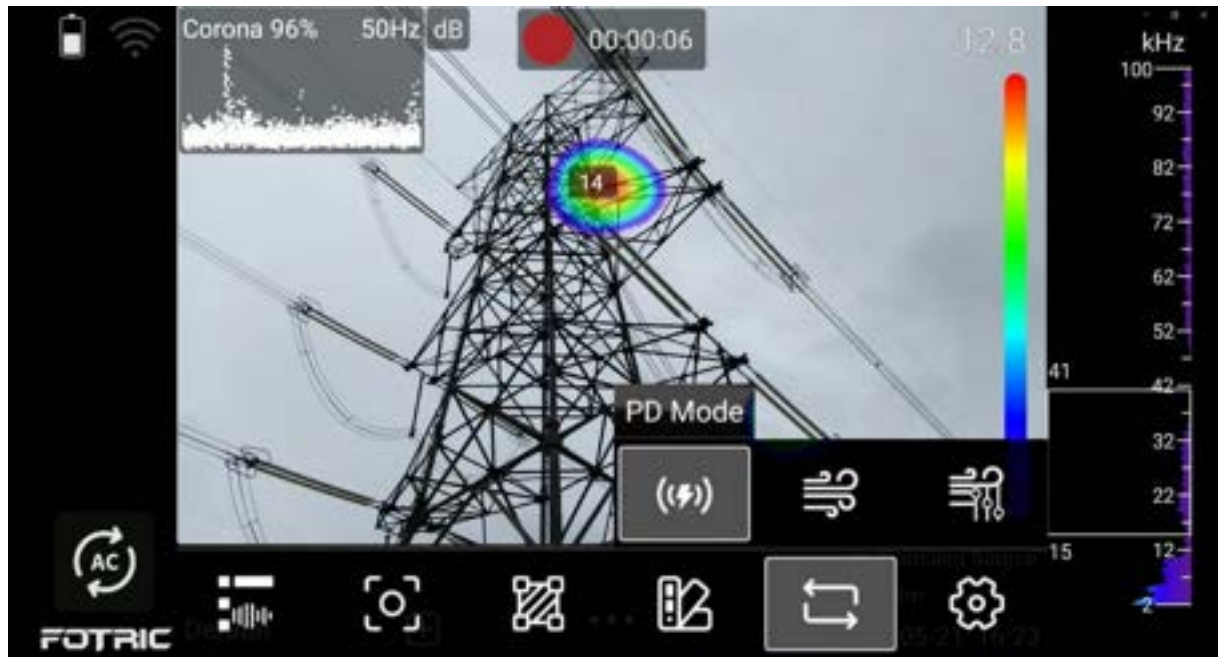

Leak detection mode:



Leak evaluation Mode:



Settings

Reference chapter 4: System Settings

5 System Settings

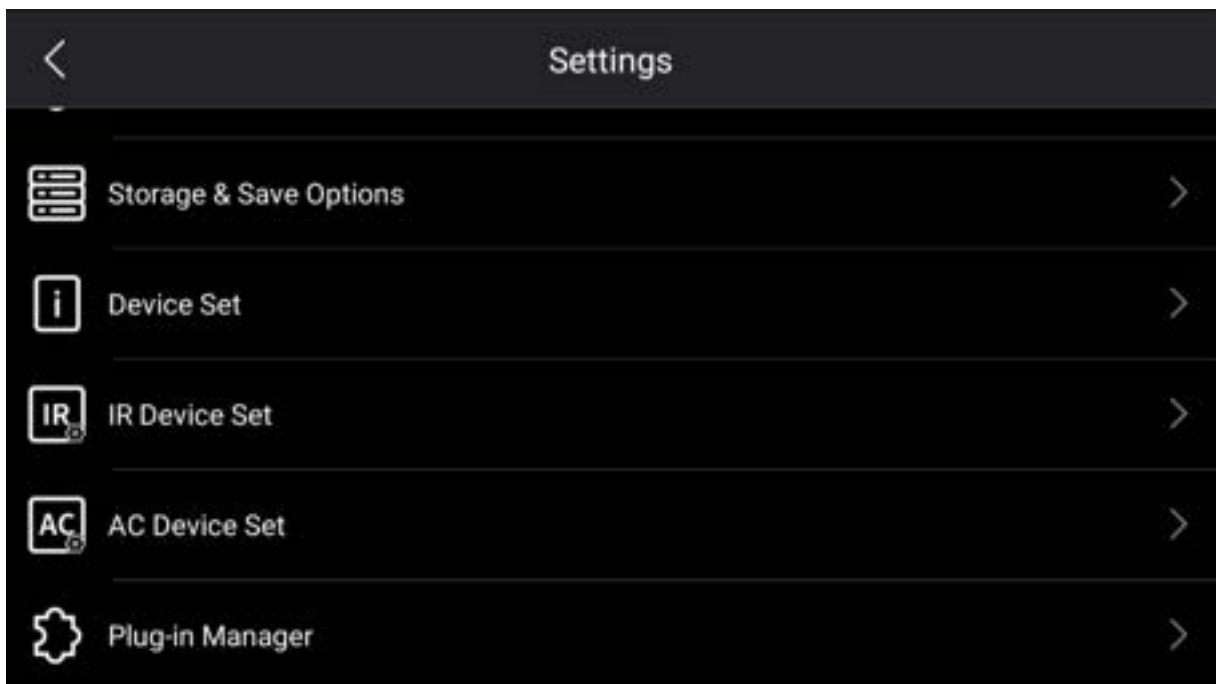
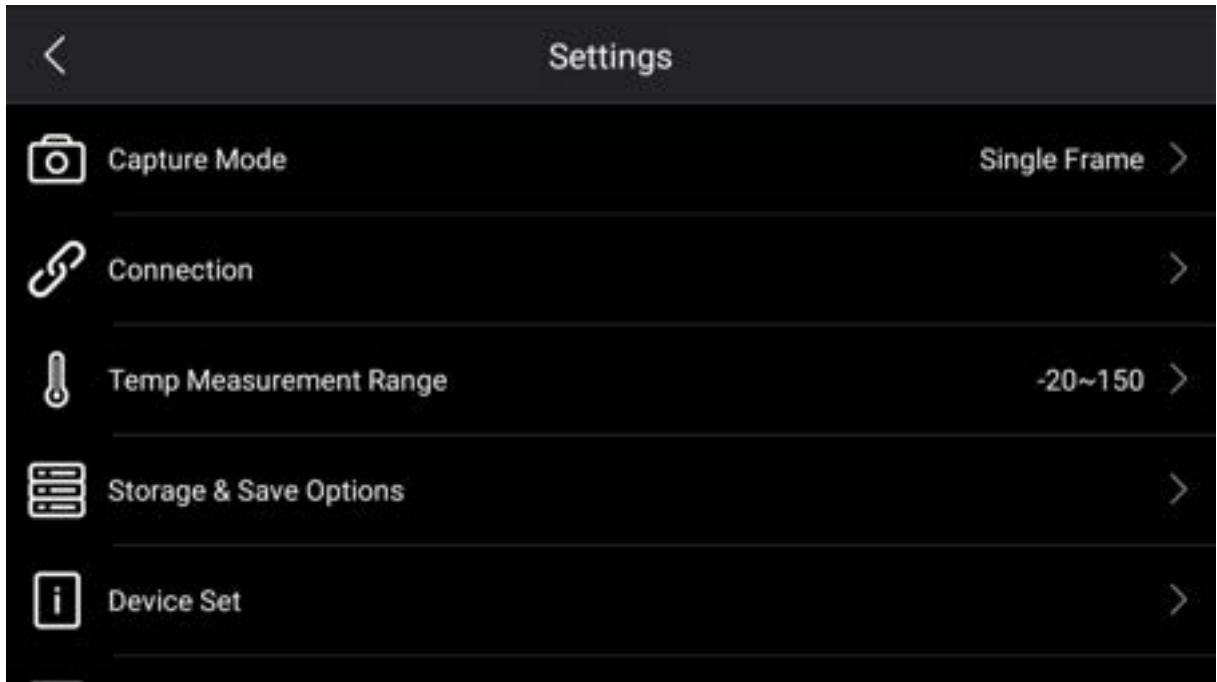

The Acoutherm Imager Setup menu includes the following options:

- Capture mode;
- Connections;

- Temperature measurement range;
- Storage & save options;
- Device Set
- IR device set
- Acoustic set
- Plug-in manager

5.1 Capture Mode

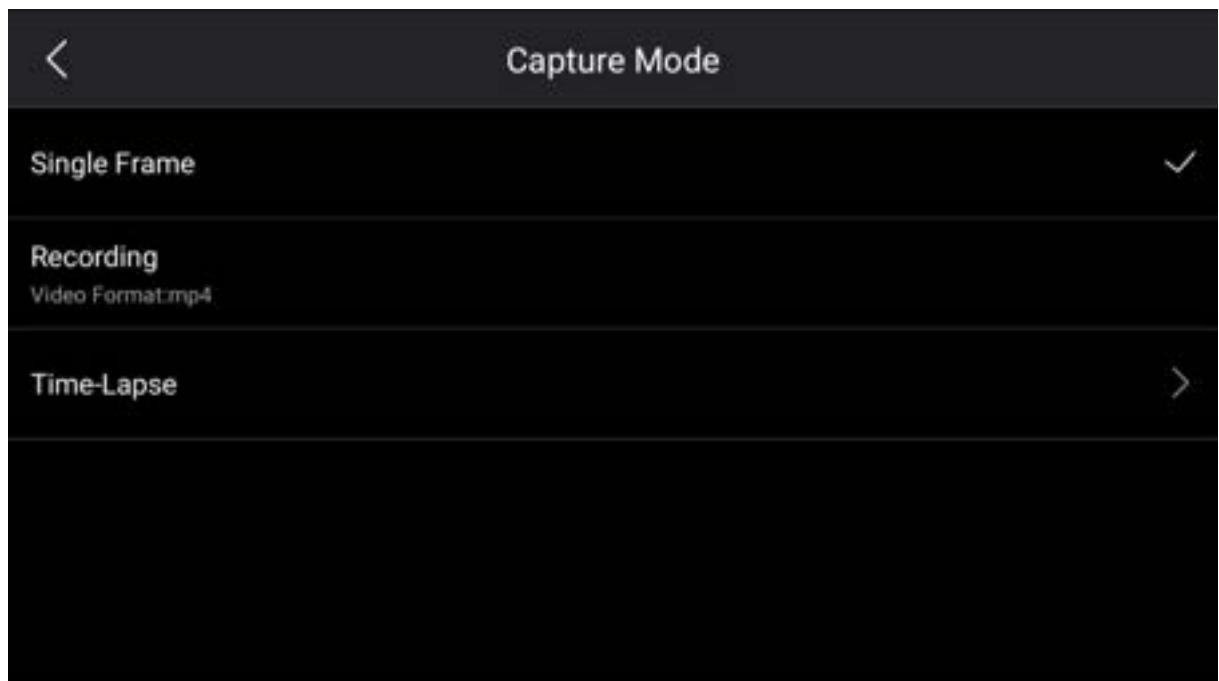

Single-frame shooting, recorded video, and timed shooting can be set. Pressing the photo trigger when set to single-frame shooting takes a picture.

4.1.1 Video recording

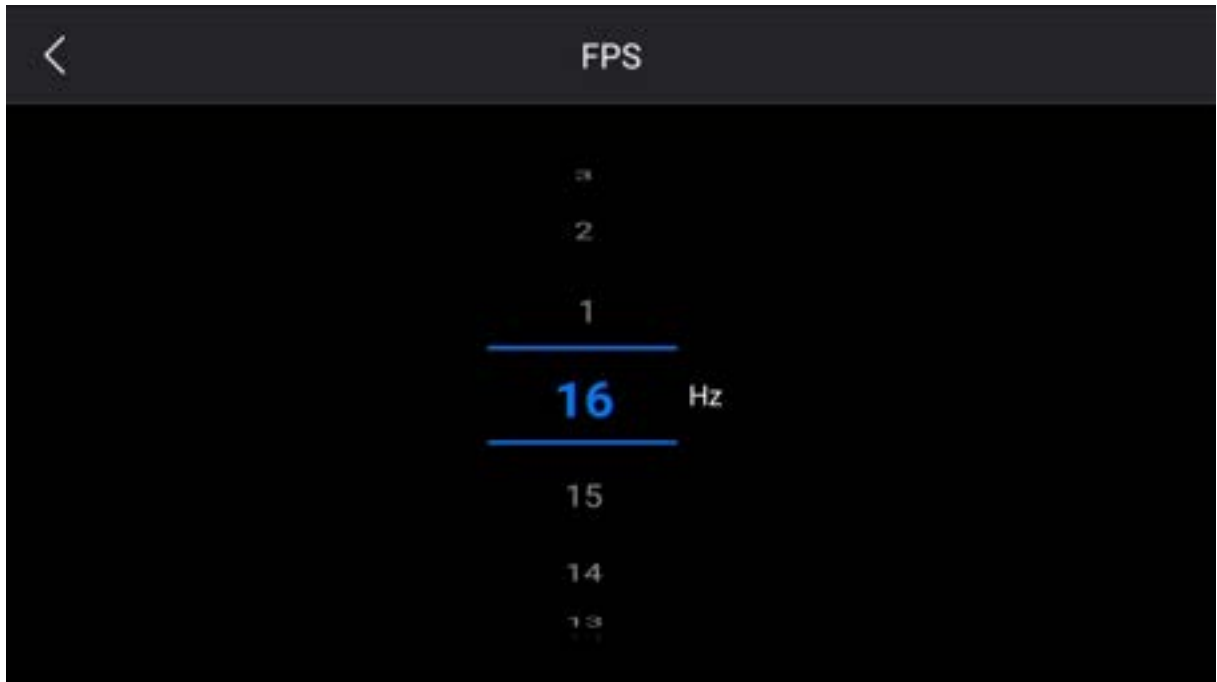

1. The recording frame rate can be set between 1~16 frames, and the shooting mode is automatically selected as video recording after selection;
2. Set to record and press the photo trigger to start recording, press the photo trigger again to pause;
3. IRS and MP4 files are supported. IRS is a thermal image video that supports radiometric analysis, and MP4 files are normal videos;
4. The video compression format can be set in  (Settings) > Storage and Saving Options > Video format;
5. Radiometric recording supports only thermal image modes; non-radiometric recording supports all image modes.

! Note: MP4 videos will not be editable after saving the file.

4.1.2 Time-lapse



1. The minimum time interval is 2 seconds and the maximum interval is 60 minutes and 59 seconds;
2. It can be set to stop automatically after a certain number of shots, up to 1000 shots, or keep capturing until the storage or battery runs out;
3. Press the photo trigger to start shooting after selecting timed photo, press the photo trigger again to stop shooting, if the total number of images is set, it will stop automatically when the number of pictures reaches.

! Note: Mode switching is not allowed during timed shooting, only thermal image mode is supported, no operation is supported, and only focus operation can be performed.

5.2 Connection

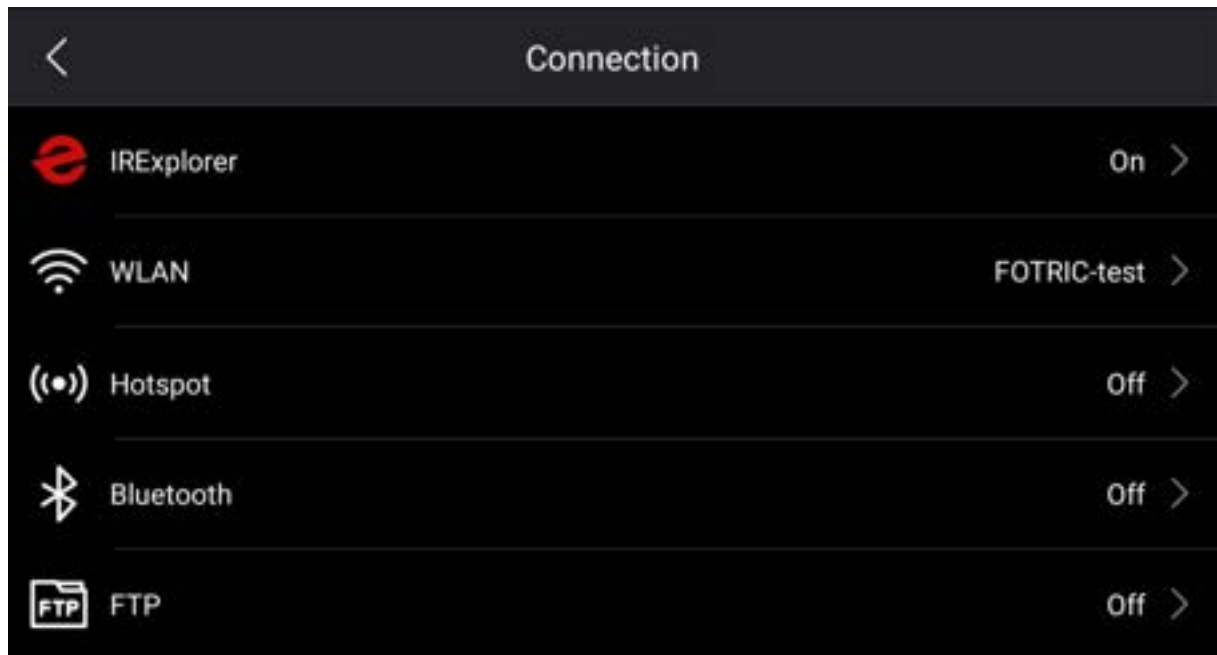

The connection allows users to set up IRExplorer, wireless network connection, portable hotspot settings, Bluetooth connection and FTP transfer.

5.2.1 IRExplorer

IRExplorer page to view web links, changeable usernames, passwords and scanned QR codes

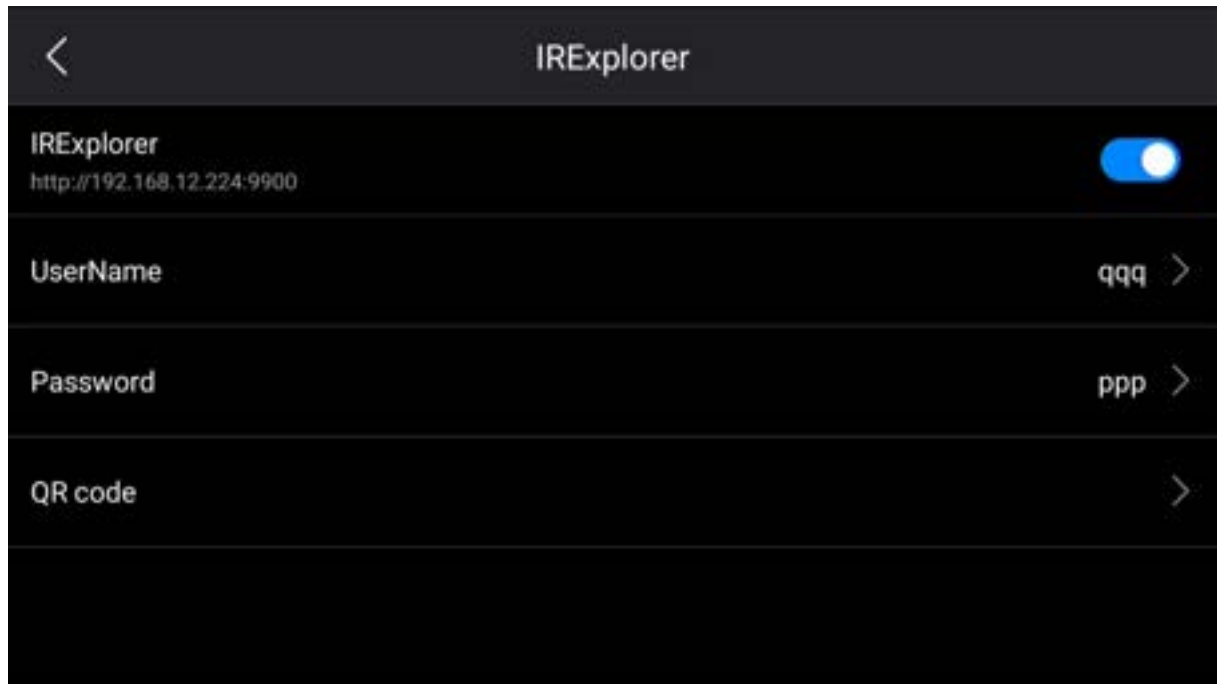

1. Tap on the acoutherm Imager screen. This displays the Main Menu toolbar;
2. Select Settings;
3. Select "Connections" -> "IRExplorer";
4. Flip the switch to view the IP address, and after turning it on, users can enter the IRExplorer login screen by entering the IP address using user's computer/mobile phone;
5. Login with username and password
6. Users can also scan the QR code to go directly to the login screen.

5.2.2 WLAN (Wi-Fi)

The acoutherm imager can utilize Wi-Fi to connect the acoutherm imager to a wireless local area network (WLAN).

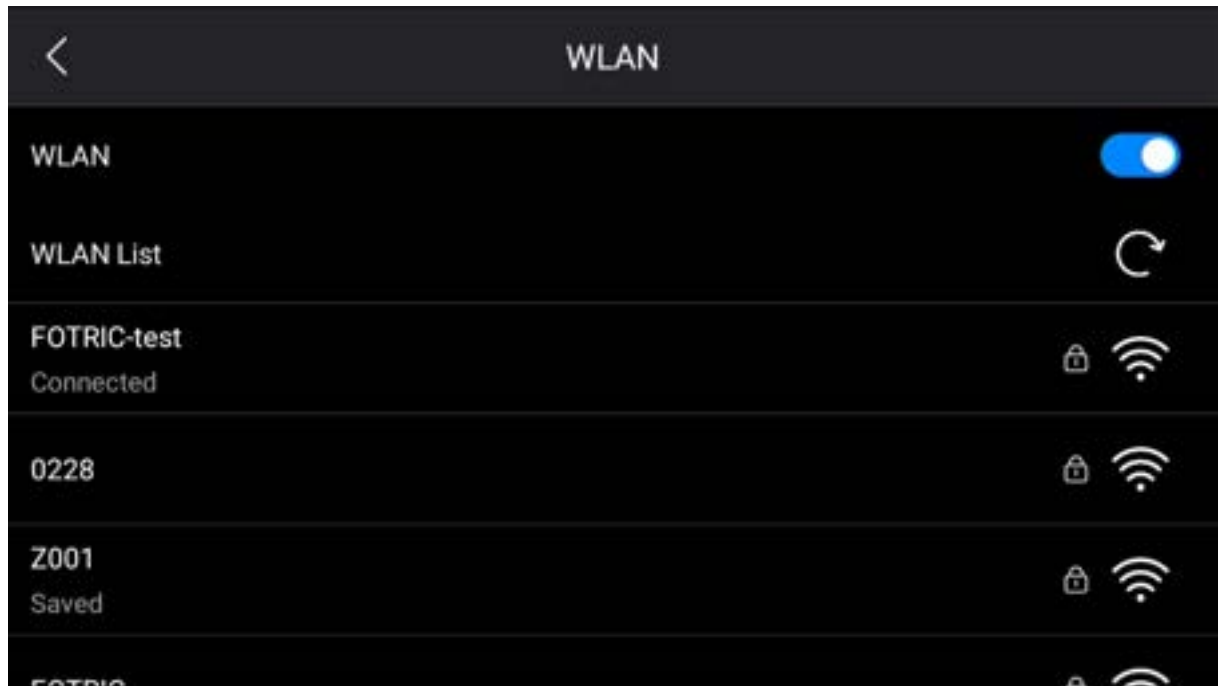

1. Tap on the acoutherm Imager screen. This displays the Main Menu toolbar;
2. Select Settings;
3. Select "Connections" -> "Wireless Networks";
4. Turn on "Wireless Network". Then a list of available networks appear;
5. Select one of the available networks. Networks with password protection will be indicated by a padlock icon.

5.2.3 Portable hotspot

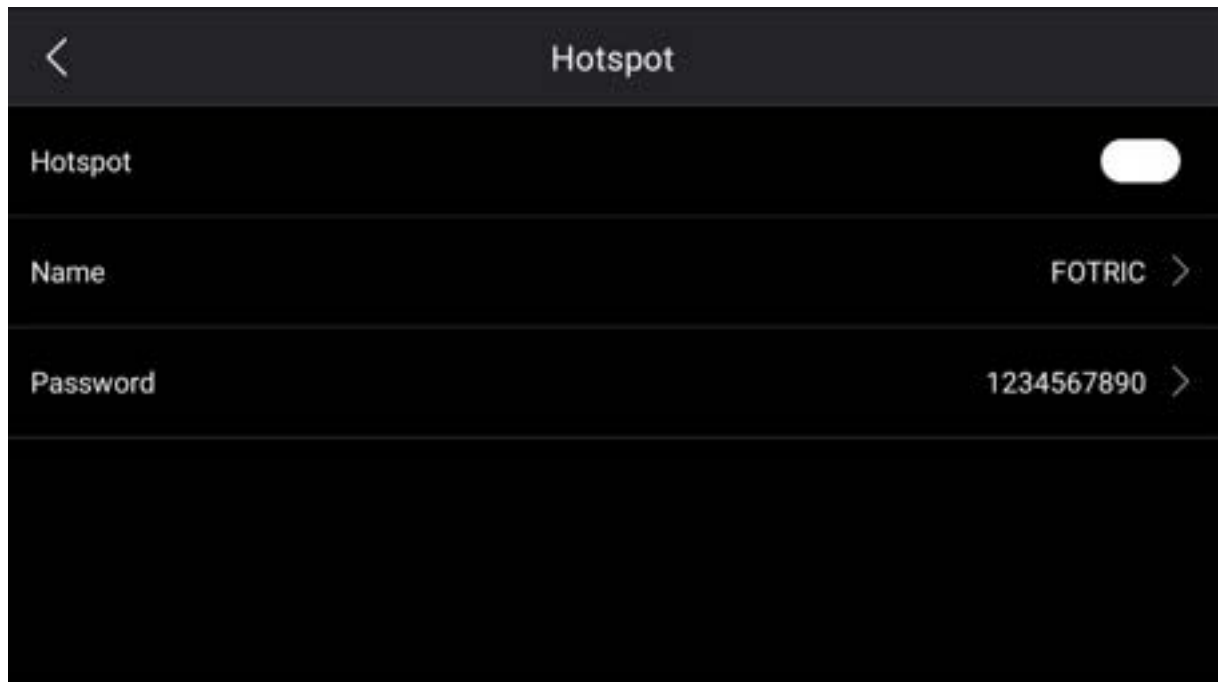

1. Tap on the acoutherm Imager screen. This displays the Main Menu toolbar;
2. Select Settings. Enter the Settings screen;
3. Select "Connections" -> "Portable Hotspot";
4. Select Turn on Portable Hotspot;
5. Configurable name and password for the hotspot;
6. To transfer data using FTP, connect a device to the acoutherm imager via a hotspot.

5.2.4 Bluetooth

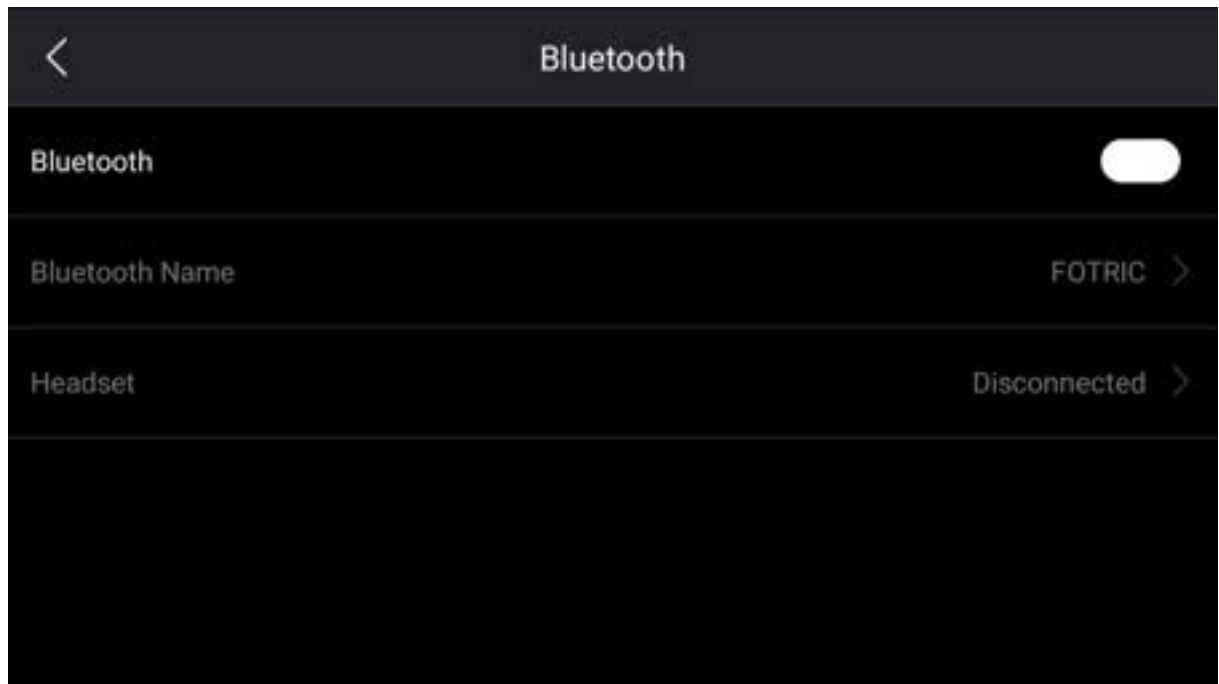

The acoutherm Imager can be used to pair with other Bluetooth devices using a Bluetooth headset connection, and after adding a Bluetooth-enabled headset, users can use it to add voice notes. Adding a Bluetooth-enabled headset will automatically disable the built-in microphone and speaker.

5.2.5 FTP data transfer



FTP transfer, when the service is turned on, users can connect to the acoutherm imager via other FTP clients for SD card file transfer.

Via "Settings" -> "Connections" -> "FTP Transfer".

1. Connect the client and the acoustic imager to the same WLAN or connect the client to the acoustic imager's hotspot and enable FTP transfer;
2. After successful opening, the type address will be displayed: ftp://IP:端口. Users can connect to the acoutherm imager FTP service by entering the ftp address through a client browser, file manager or FTP client tool for file transfer;
3. Can be configured to allow anonymous access or not. If anonymous access is enabled, the client does not need to perform any authentication and can connect to the device's FTP service to operate the file system;
4. If anonymous access is turned off, the client needs to enter the configured username and password to access the file system.

! Note: WLAN mode, requires the client to be connected to the same WLAN;

Hotspot mode, requires the client to be connected to the acoutherm imager hotspot before it can be accessed.

5.3 Temperature Range (only visible in IR mode)



Via Settings->Temperature Range

1. A suitable temperature range can be selected for temperature measurement;
2. Select the temperature range to meet the general two principles, the first measured object temperature to be within the range, the second to meet the first on the basis of trying to choose a small range of range imaging effect is better;
3. Intelligent ranges can also be selected, where the acoutherm imager automatically switches the temperature range based on the current temperature of the object being measured.

Temperature ranges vary by model, and the unit of the temperature measurement range depends on the temperature unit setting.

! Note: It is possible to assign the operation of switching the temperature range

of the acoutherm imager to the AI button.

5.4 Storage & Saving Options

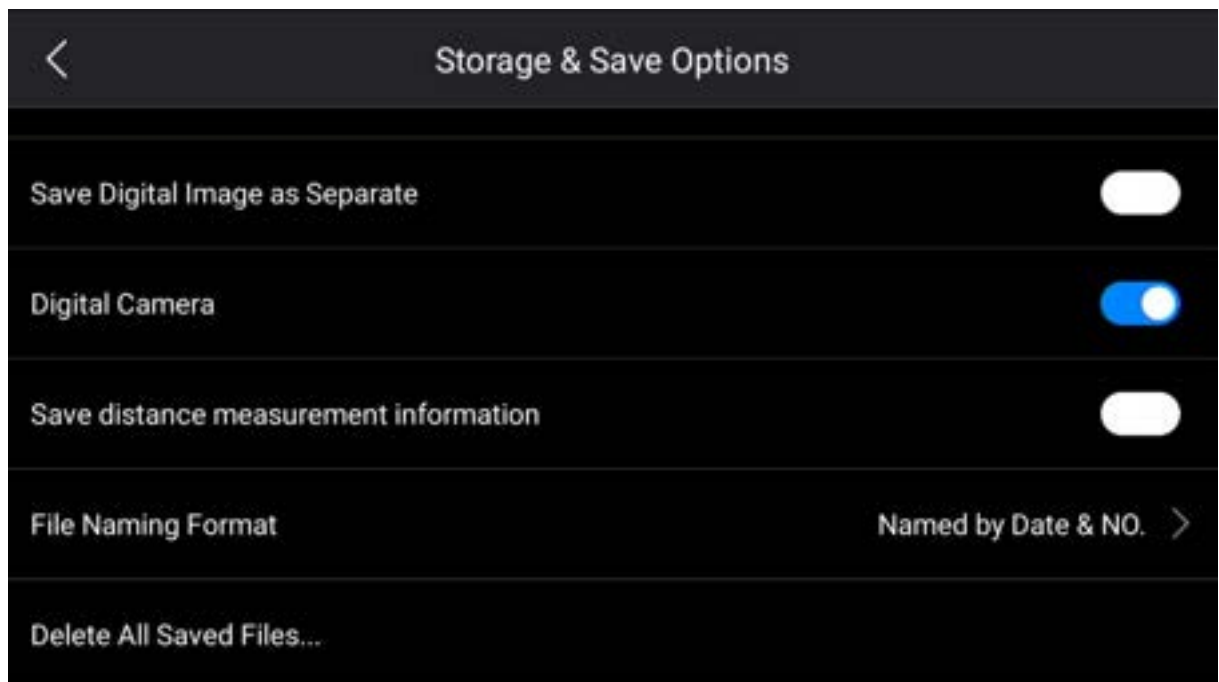
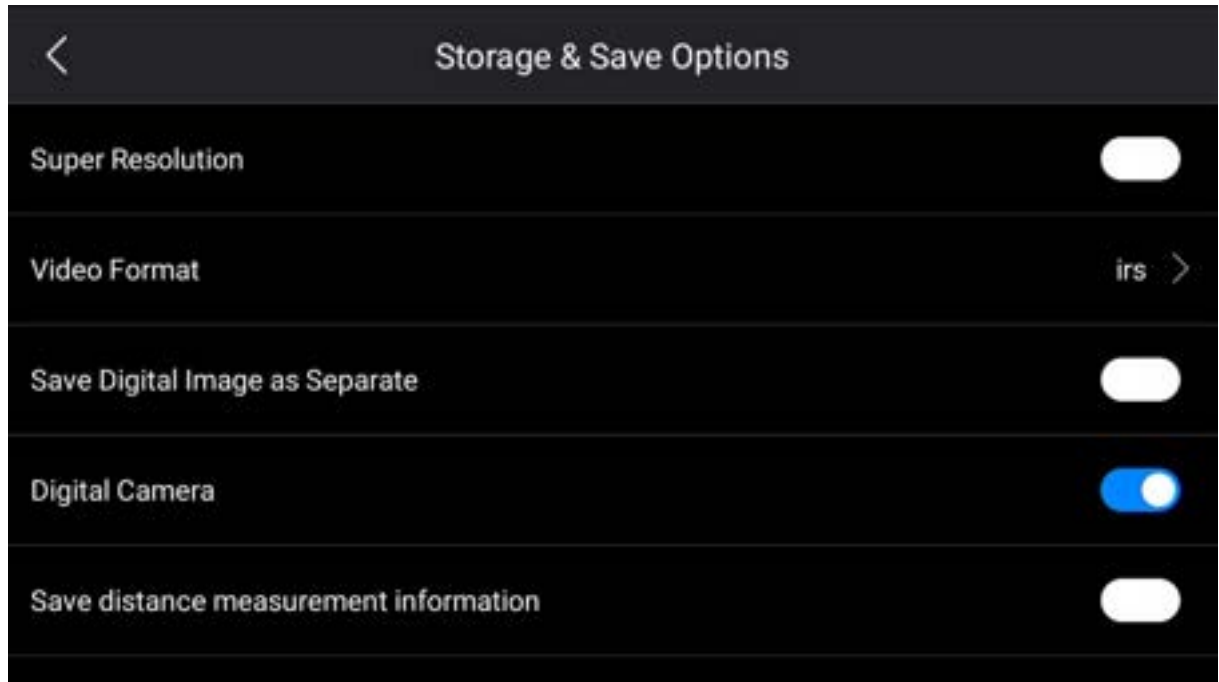

- Super Resolution: When turned on, the pixels of the captured thermal image become 4 times the standard pixels, super pixels are not supported when recording videos and timed shots.

- Video Format: this setting defines the format in which the video clips are stored. Available options are:

MP4 (*.mp4): the file is playable but not editable, the content of the recorded video for the recording of the entire screen content, while recording the user's operating behavior;

IRS file (.IRS): a radiometric video file that supports radiometric analysis, and the file can be analyzed and edited later.

- Save Digital Image as Separate: For IR images, Picture-in-Picture image mode, and blend mode, the digital image is always saved in the same JPEG file as the IR image.
- Save distance measurement information: This setting defines whether or not a laser ranger is used to measure the distance when saving an image. If this setting is selected, the measured distance will automatically be used to update the object distance parameter in the image data when the image is saved (this has no effect on the object distance settings in live mode.)
- Digital Camera: when turned off, the user will only be able to use thermal image mode and will not be able to access digital camera, picture-in-picture, and blend modes.
- File naming format can be selected: date serial number naming, serial number naming
- Deleting all saved files... : This displays a dialog box in which users can choose to permanently delete all files (images and videos) saved on the memory card, or cancel the deletion operation.

5.5 Device Set

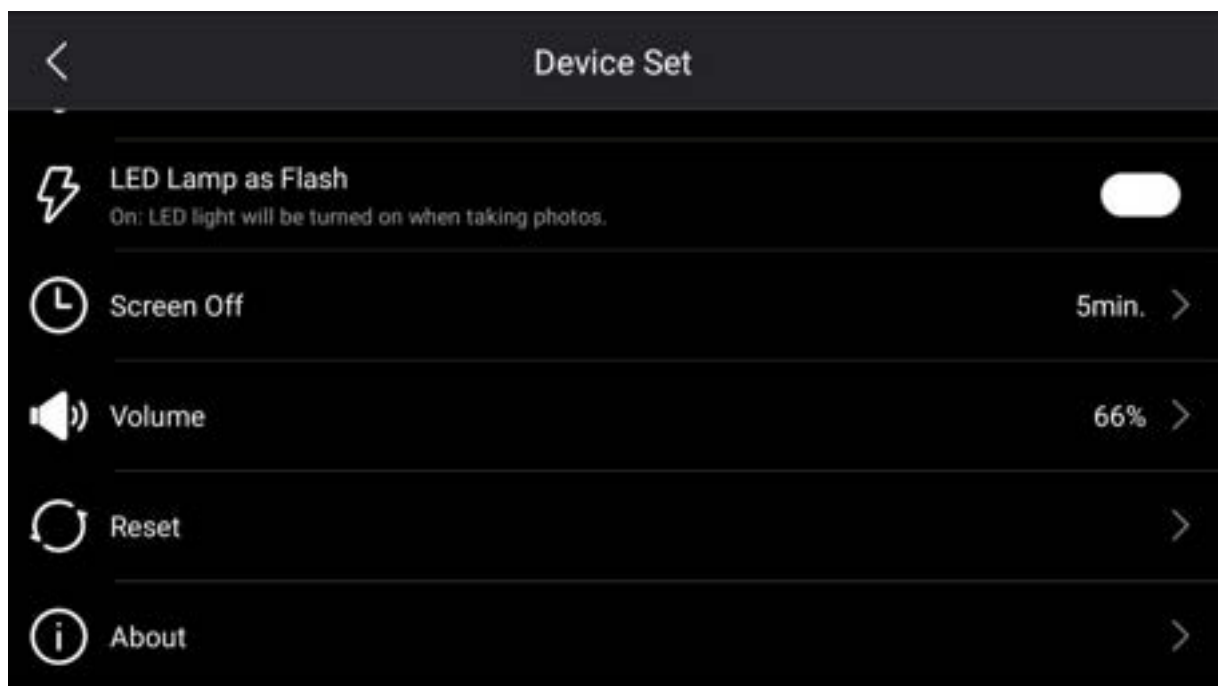
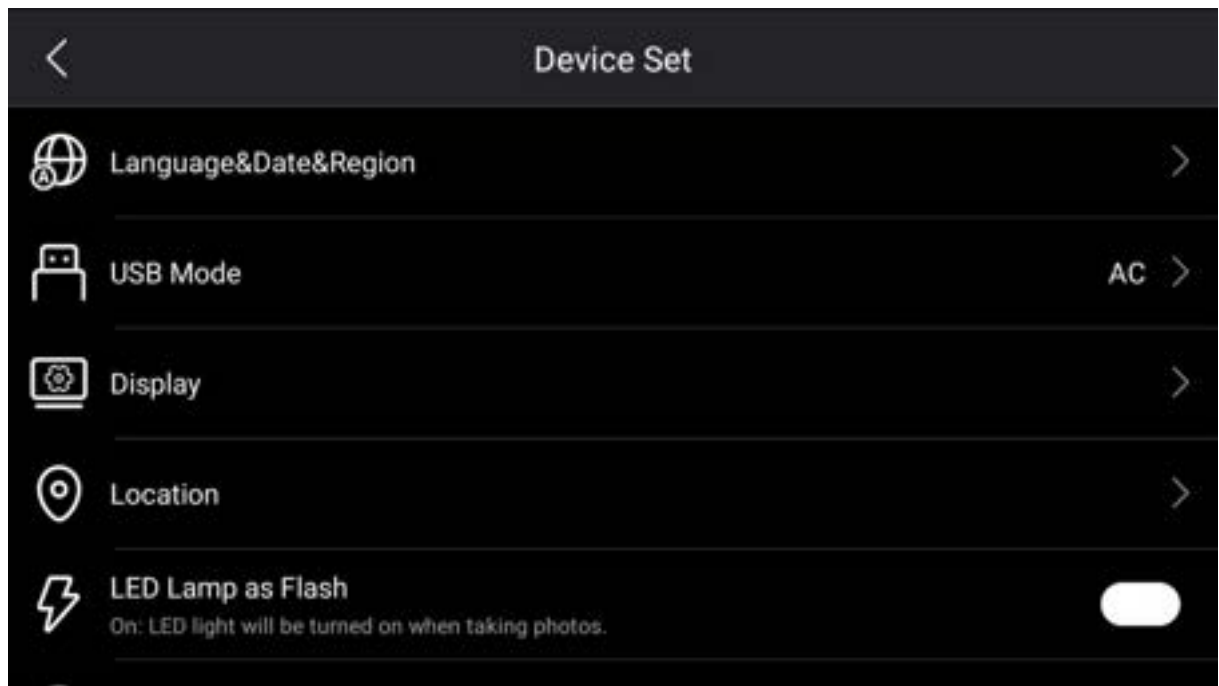

5.5.1 Language & date & region

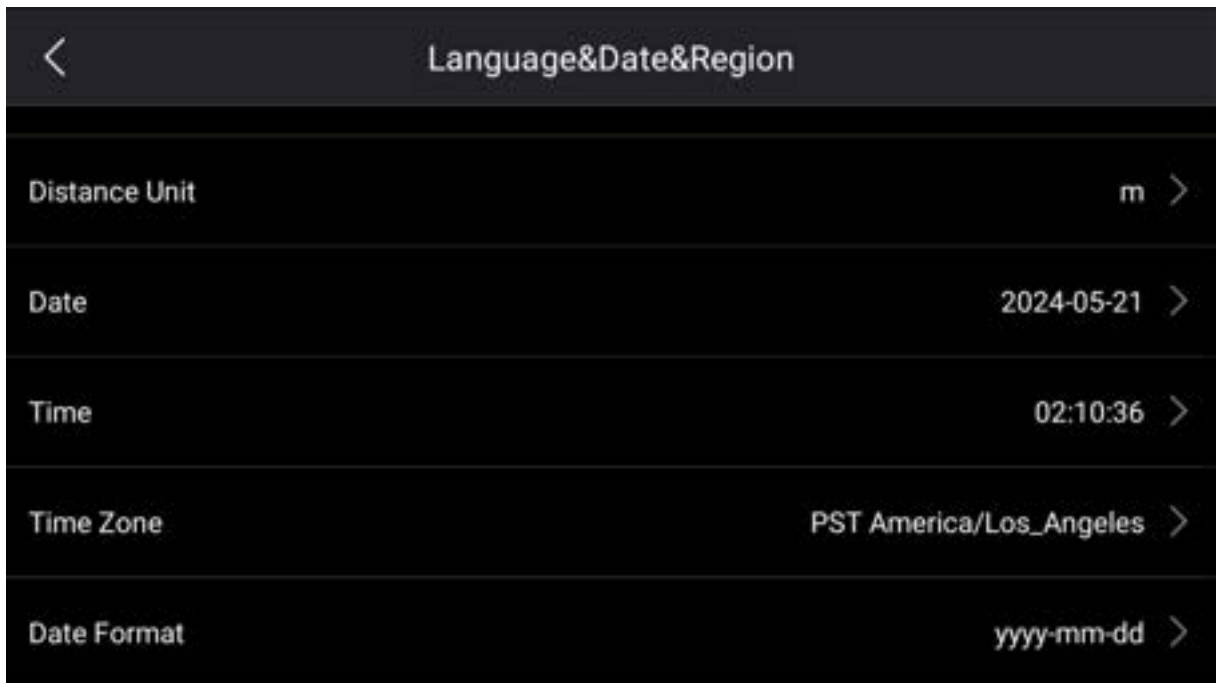

- This sub-menu contains settings for the following parameters: language, temperature units, distance units, date, time, time zone, date format settings.
- Languages: English, Traditional Chinese, Spanish, Korean, German,

Portuguese, Italian

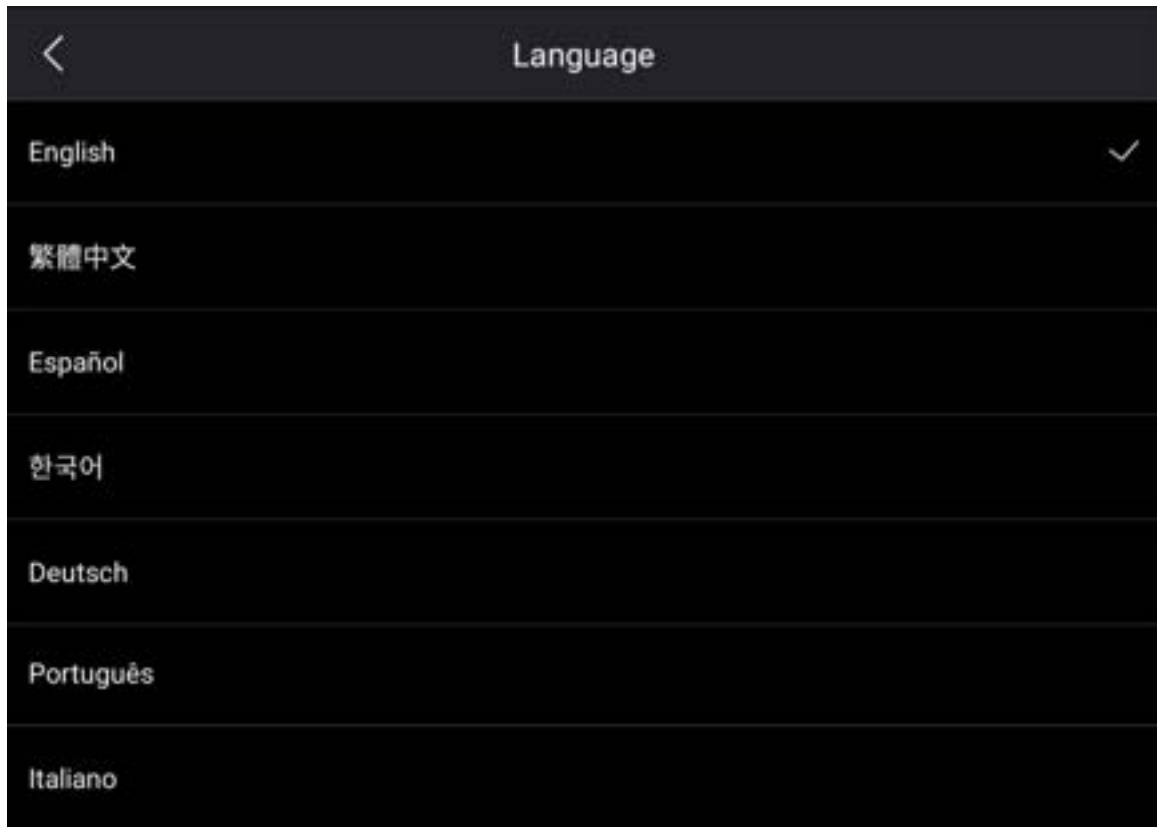

- Temperature Units: ° C, K, °F.

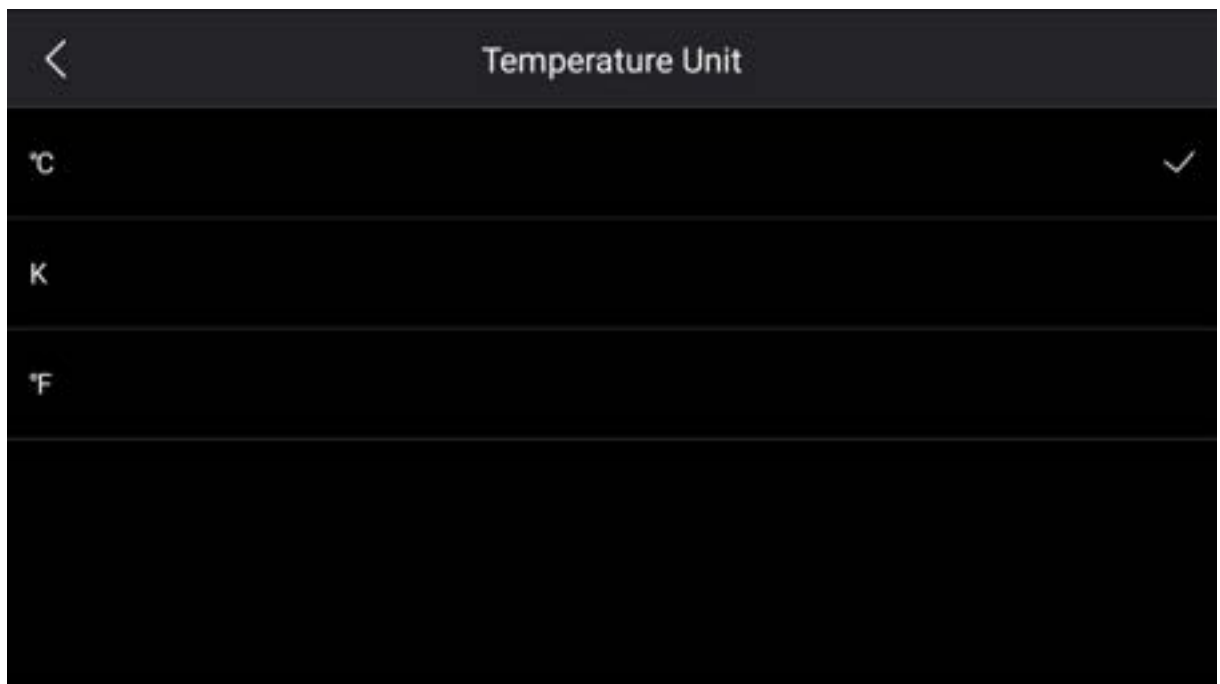

- Distance Units: m, ft.

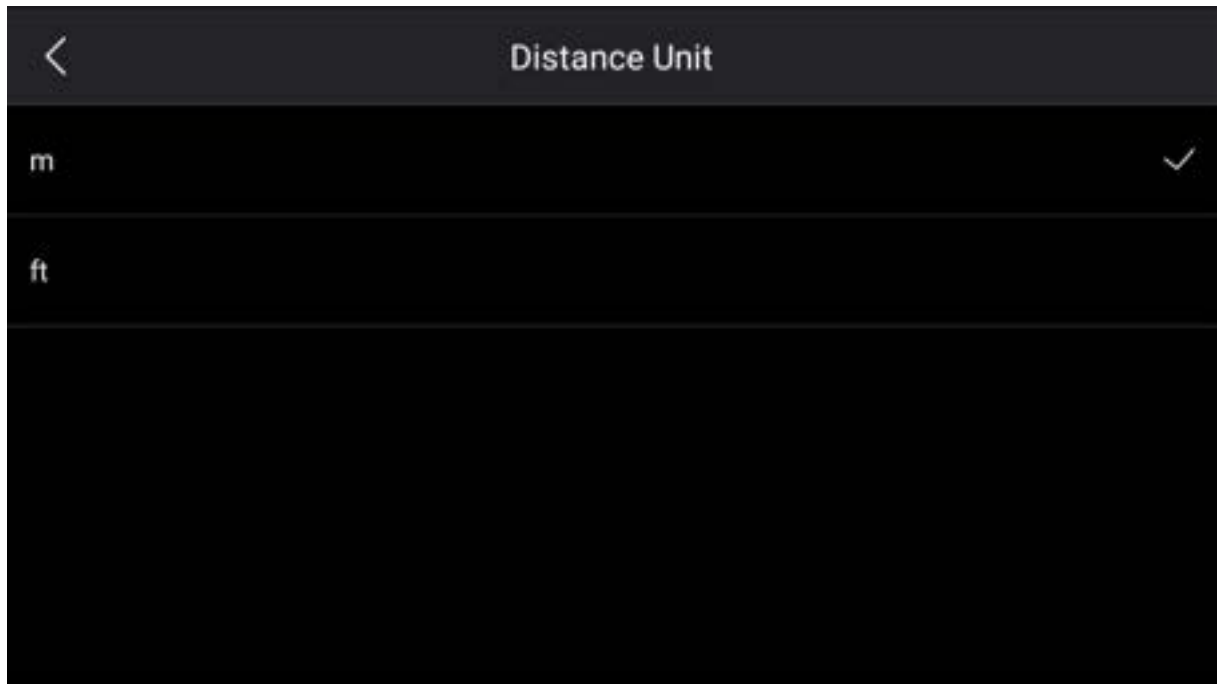

- Date



- Time

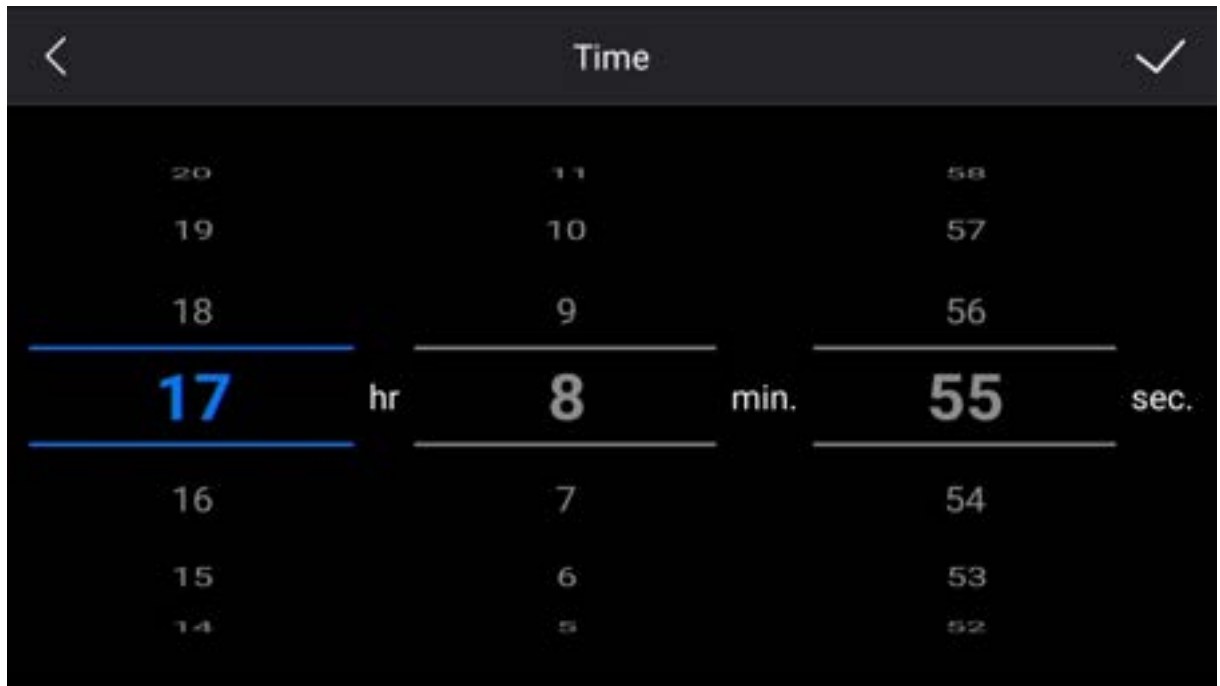

- Time Zone

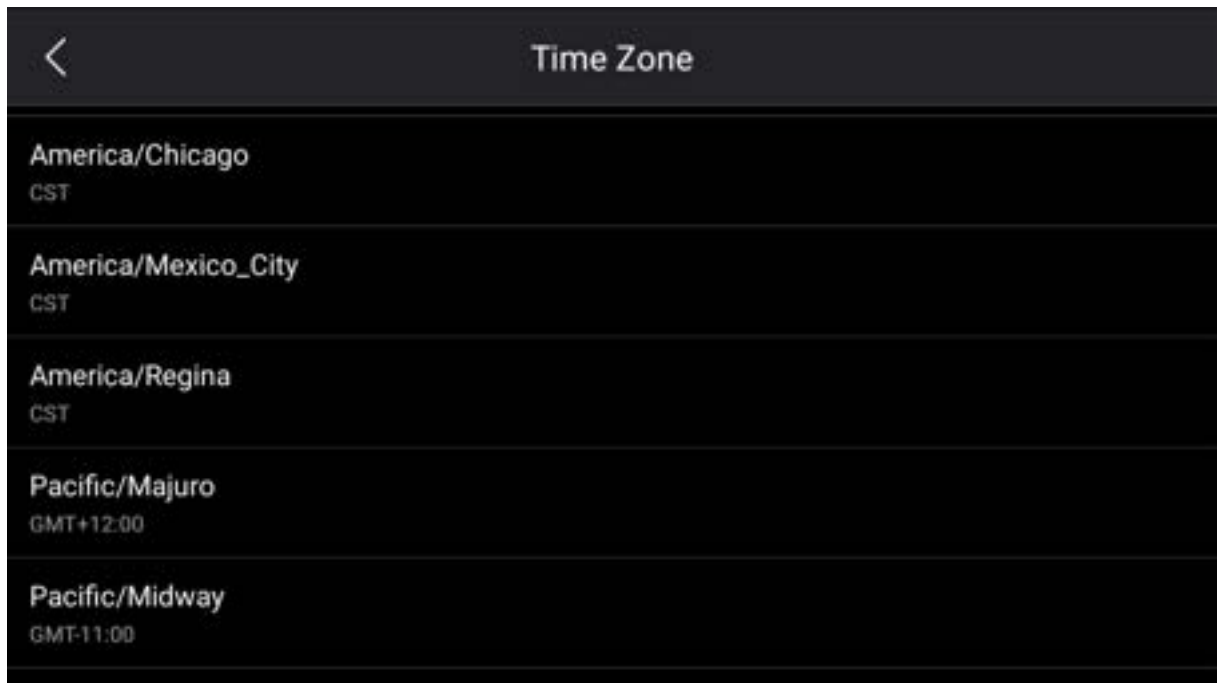

- Date Format

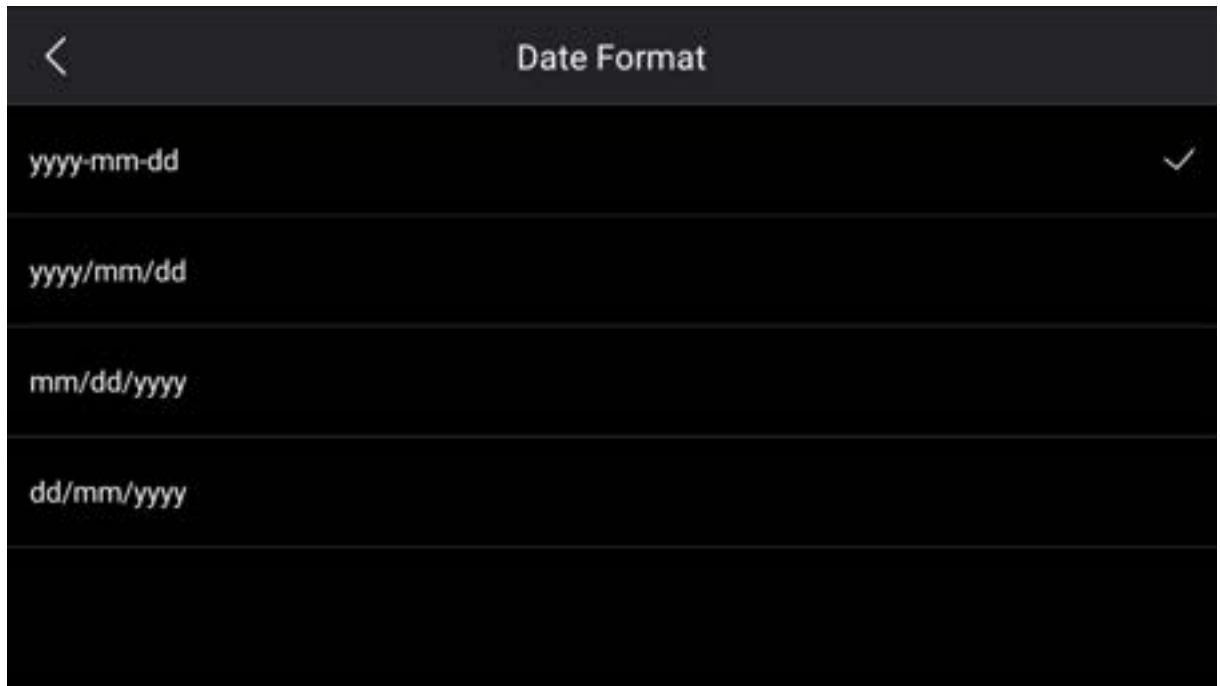

5.5.2 USB mode

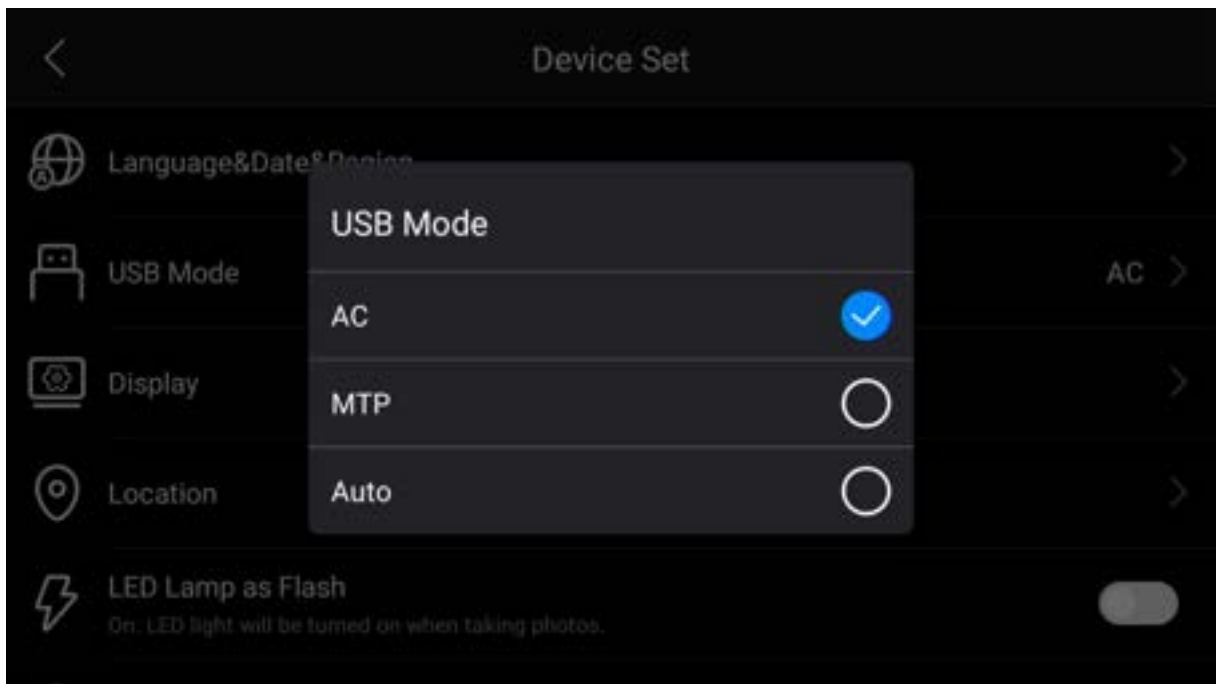

Mode in which USB can be switched: into sound and video, transferring files (MTP)

5.5.3 Display

- Display Settings: Slide to adjust screen brightness

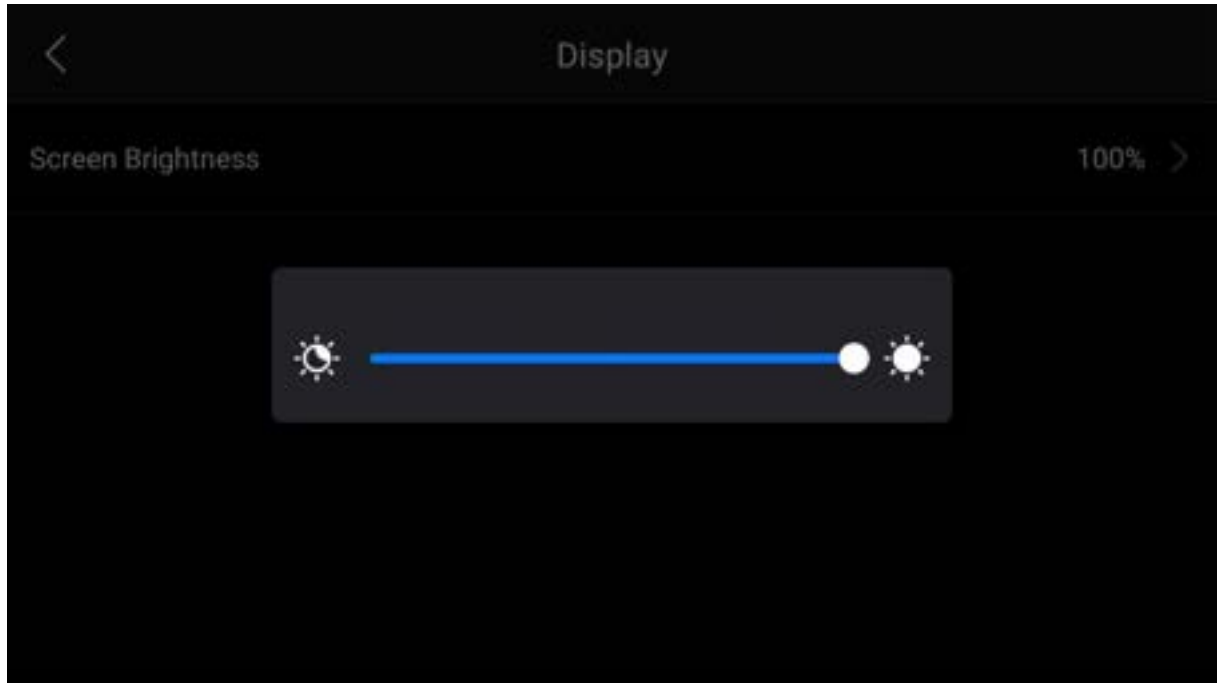

5.5.4 Location

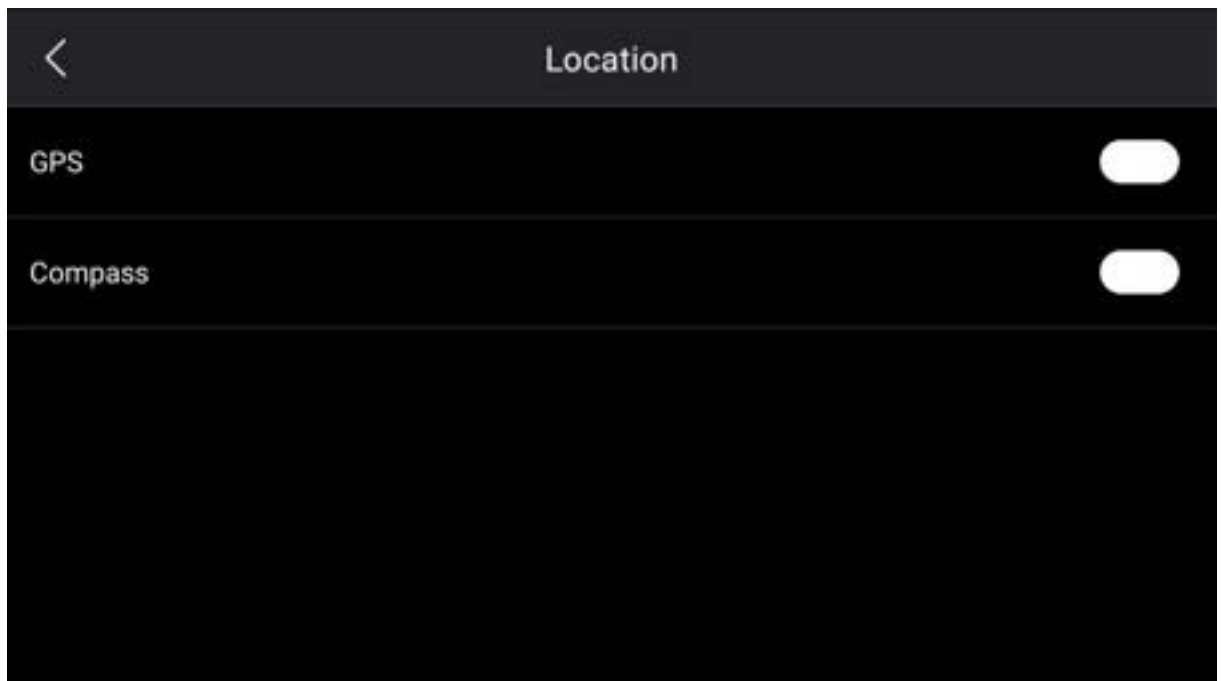

- 1) GPS: This setting is used to enable/disable GPS;

2) Compass: This setting is used to enable/disable the compass.

5.5.5 LED lamp as flash light

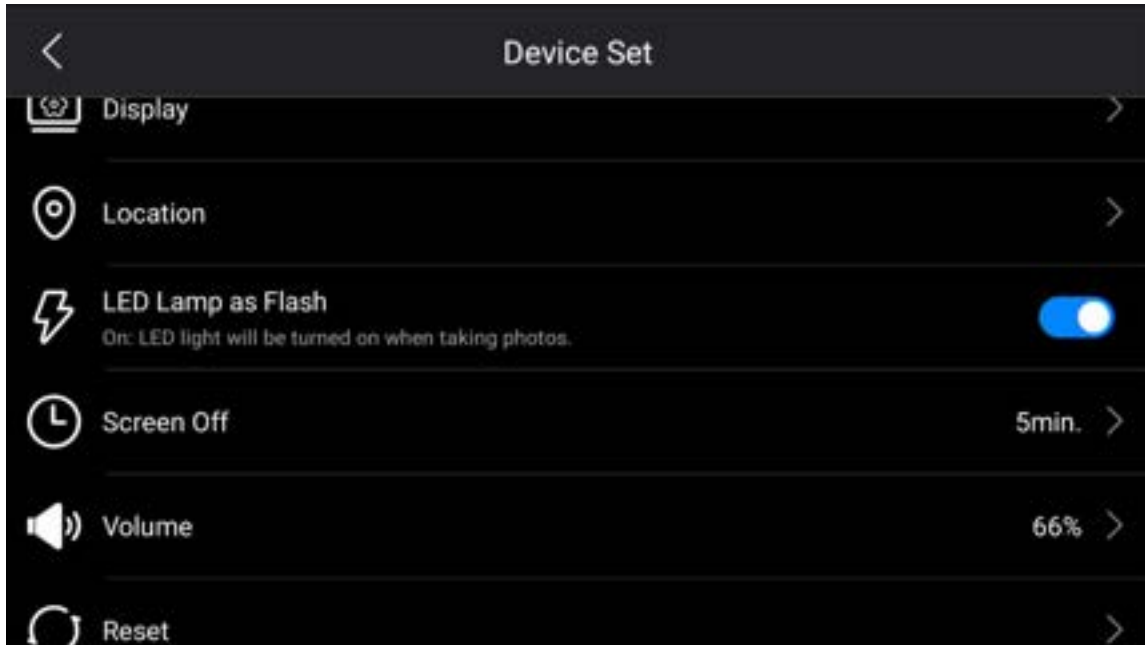

The acoutherm Imager LEDs can be used as a flash for digital cameras. If the flash function is enabled, the Thermal Imager LED light will enable the flash function when the trigger button is pressed to save the image. The Thermal Imager LED can also be used as a flashlight by turning on the Thermal Imager LED from the main screen drop-down menu.

5.5.6 Screen off

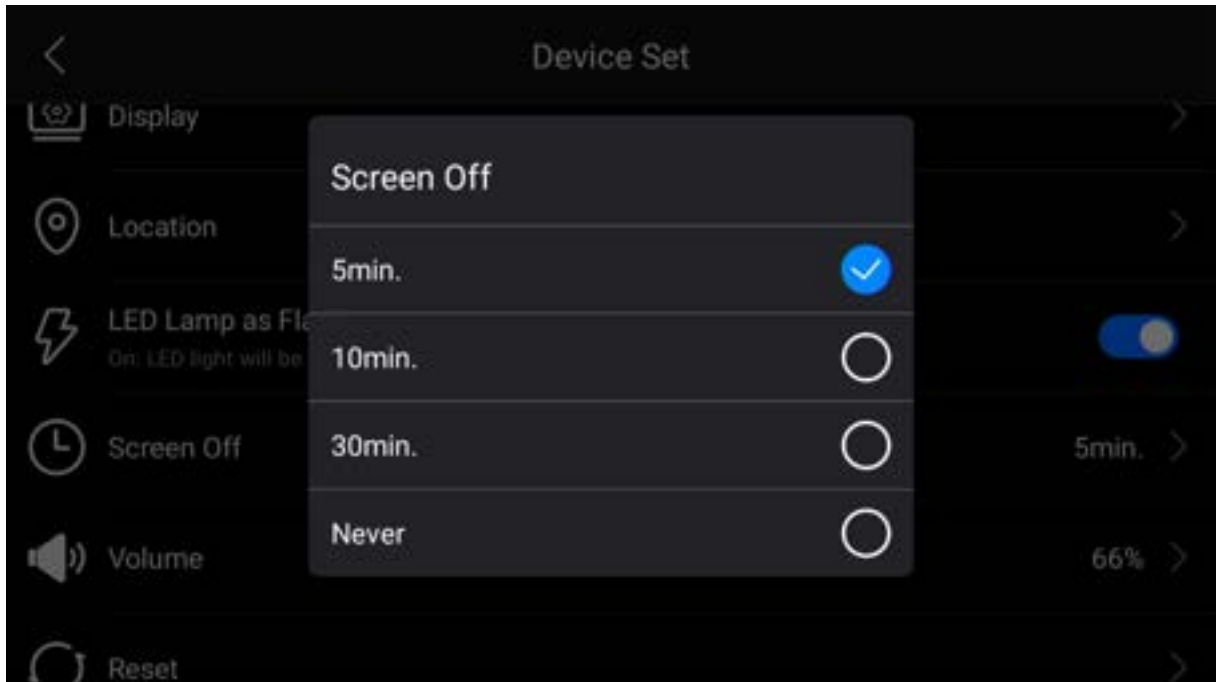

- Rest time: set how long the acoutherm imager will automatically rest the screen after it has not been operated. Supports 5 minutes, 10 minutes, 30 minutes, permanent;
- Tap on the Thermal Imaging Camera's on/off key to wake up the screen in sleep mode. Users can also manually enter sleep mode by tapping the key when using the camera.

5.5.7 Volume

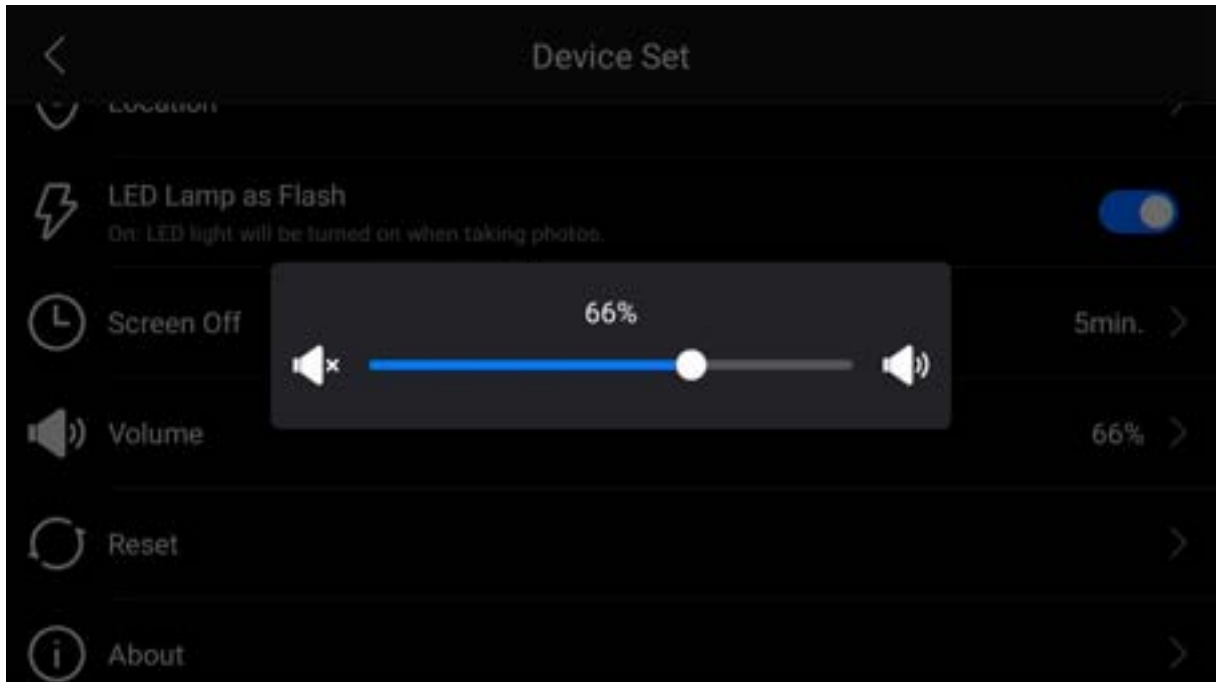

- Volume Adjustment: Adjust the volume level by sliding the round button or tapping the on-screen volume setting bar.

5.5.8 Reset

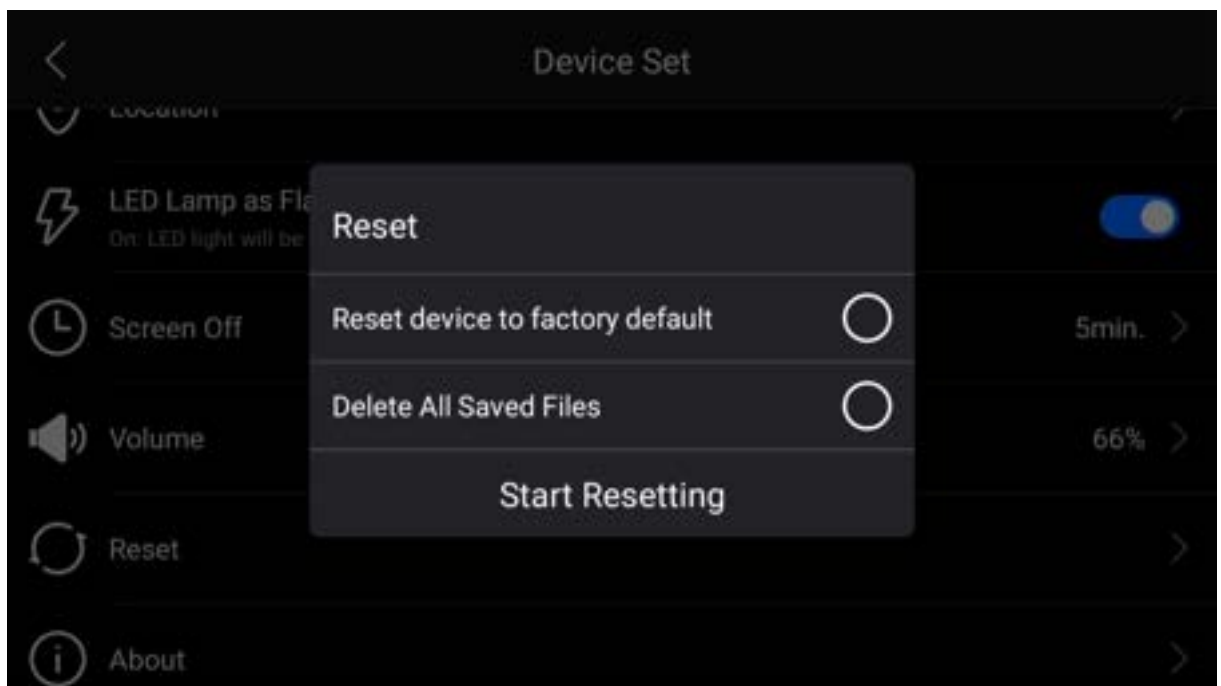

- Reset Options: Parameters are reset to factory default settings and all saved files are deleted.

5.5.9 About

About	
Model	Fotric P7 MiX
Serial Number	0801005554
Mic Channel	162
Software Version	V6.0.1
XFrame Version	V6.0.1

About	
System Firmware Version	6.0.0.0
Operation System Version	1.2.0.83
IR Sensor	2.0.1.2
AC Firmware	2.9.3.7
Lens	24.8mm L25

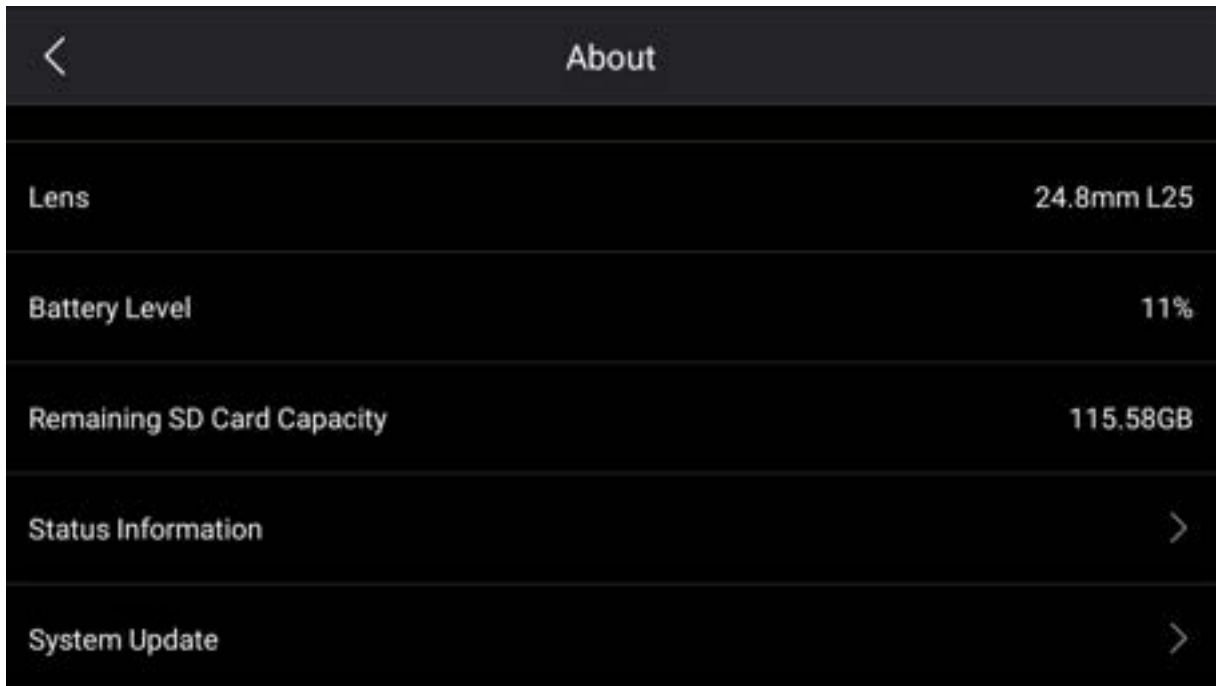

- About: Model, Serial Number, Software Version, XFrame Version, System Firmware Version, Operating System Version, IR Sensor Version, AC Firmware Version, Lens, Battery Level, Memory Card Remaining Capacity, Status Information (IP Address, Mac Address, Bluetooth Address), System Update.

5.6 IR Device Set

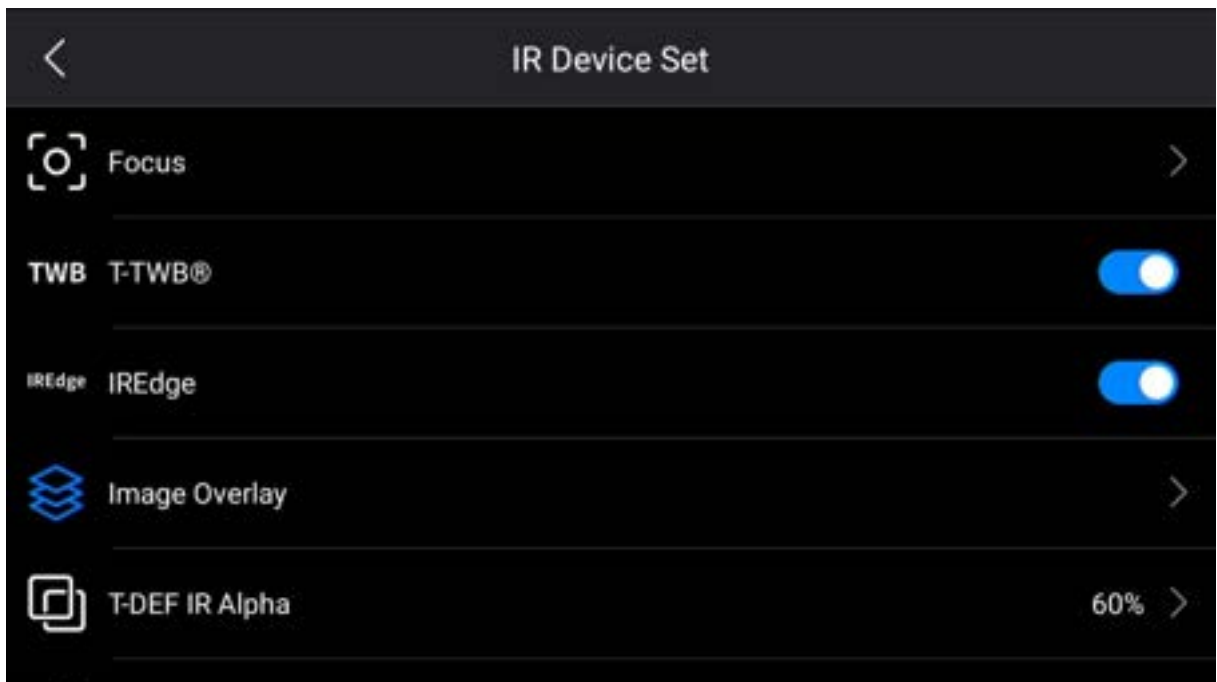



IR Device Set include: Focus, T-TWB®, IREdge, Image Overlay, T-DEF IR Alpha, and Manual Mode;

4.6.1 Focus

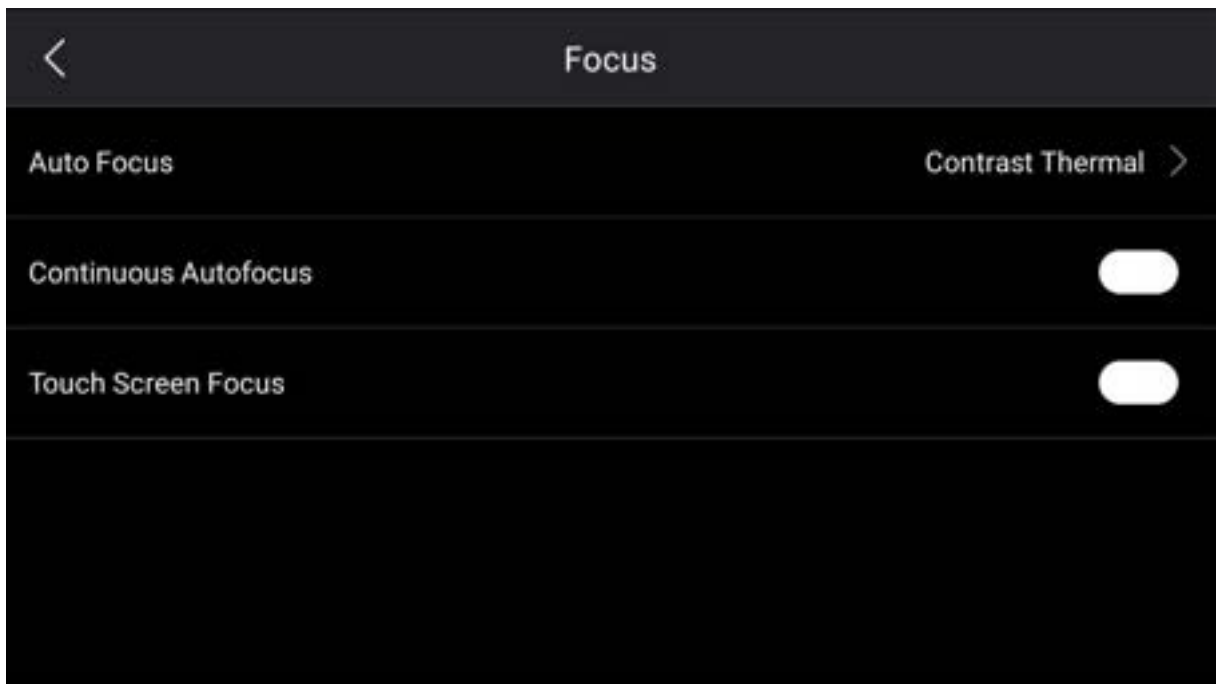

- Focus: This sub-menu contains the use of contrast for autofocus (focus will be based on maximizing the contrast of the image) and laser (focus will be based on laser distance measurements, the laser will be turned on when the acoutherm imager performs autofocus).
- Enable/disable continuous autofocus. When enabled, the acoutherm imager automatically detects motion and focuses automatically when the acoutherm imager stops moving, without pressing the focus button.
- Touch Screen Focus: control whether to turn on the touch screen focus with a switch.

4.6.2 T-TWB® and IREdge

High Temperature Differential Equalization Imaging (T-TWB®);

Image Detail Enhancement (IREdge);

4.6.3 Image overlay





- The image overlay information contains: global maximum temperature, global minimum temperature, global average temperature, emissivity, reflected temperature, ambient temperature, humidity, and distance. This setting is only used to specify what information is displayed superimposed on the image; all image information is always saved in the image file.

4.6.4 T-DEF IR alpha

- T-DEF IR Alpha: The user can adjust the default transparency of blend IR image, default value: 60%;

4.6.5 Manual mode

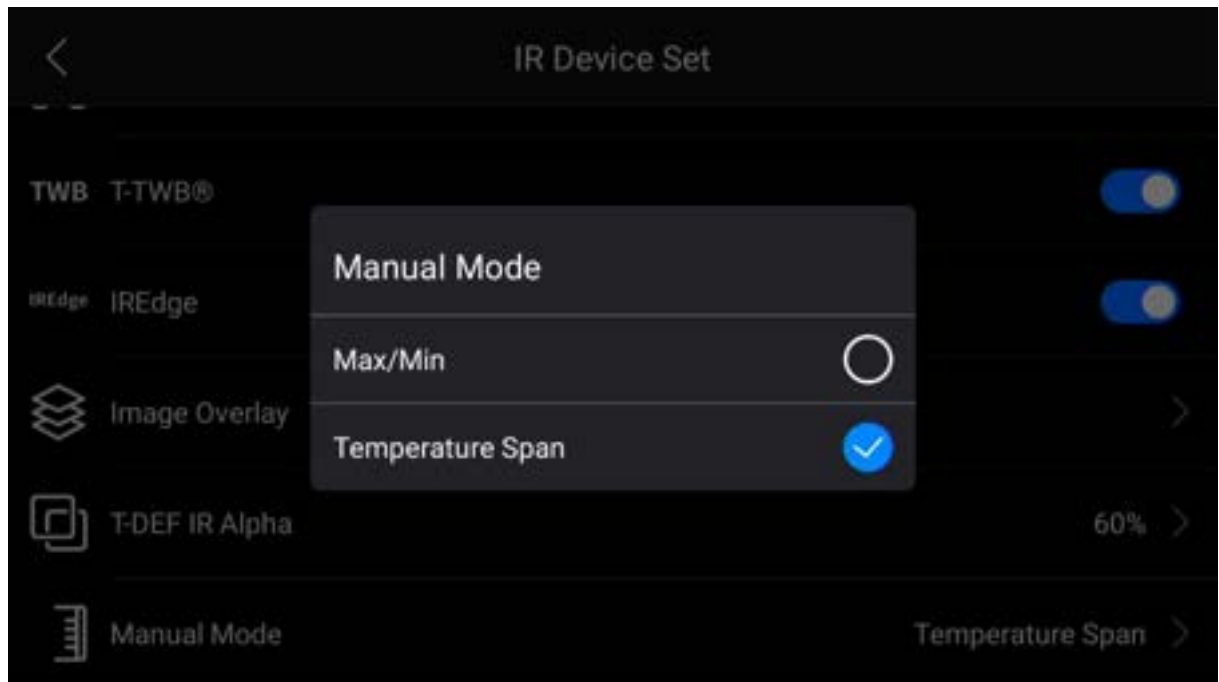

- Maximum/Minimum: The upper and lower limits can be set separately or adjusted at the same time in the temperature span setting;
- Temperature span: The span of the upper and lower limits is kept at user-selected value.

5.7 AC Device Set

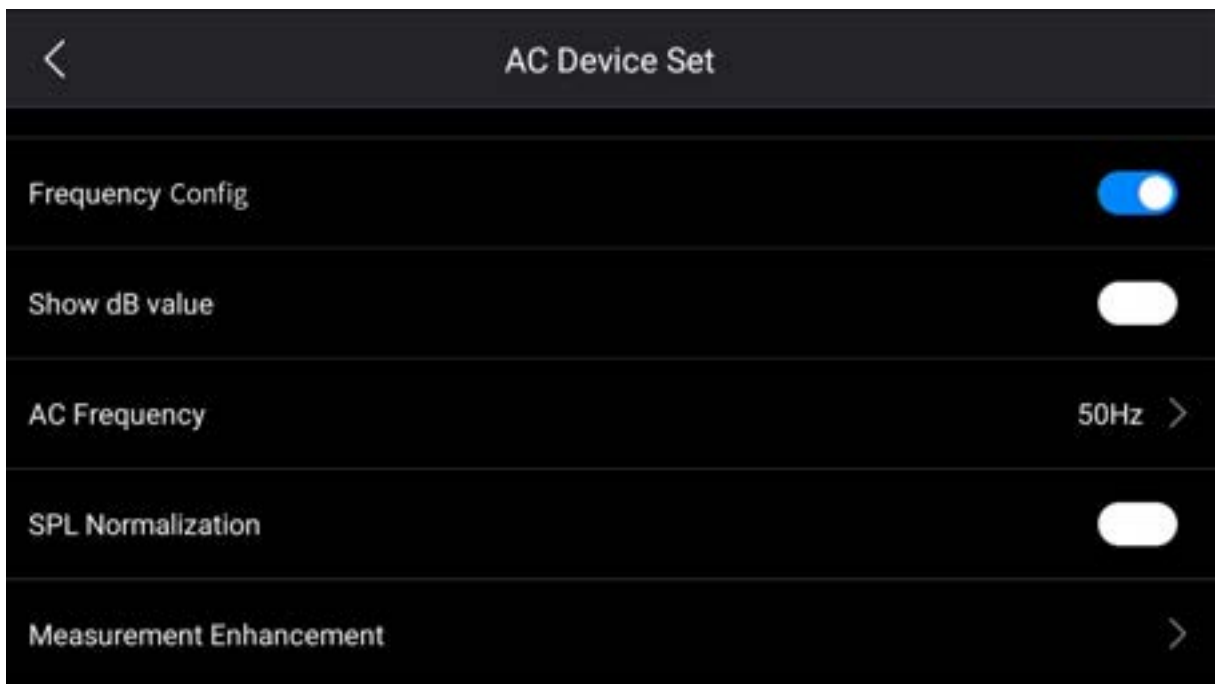
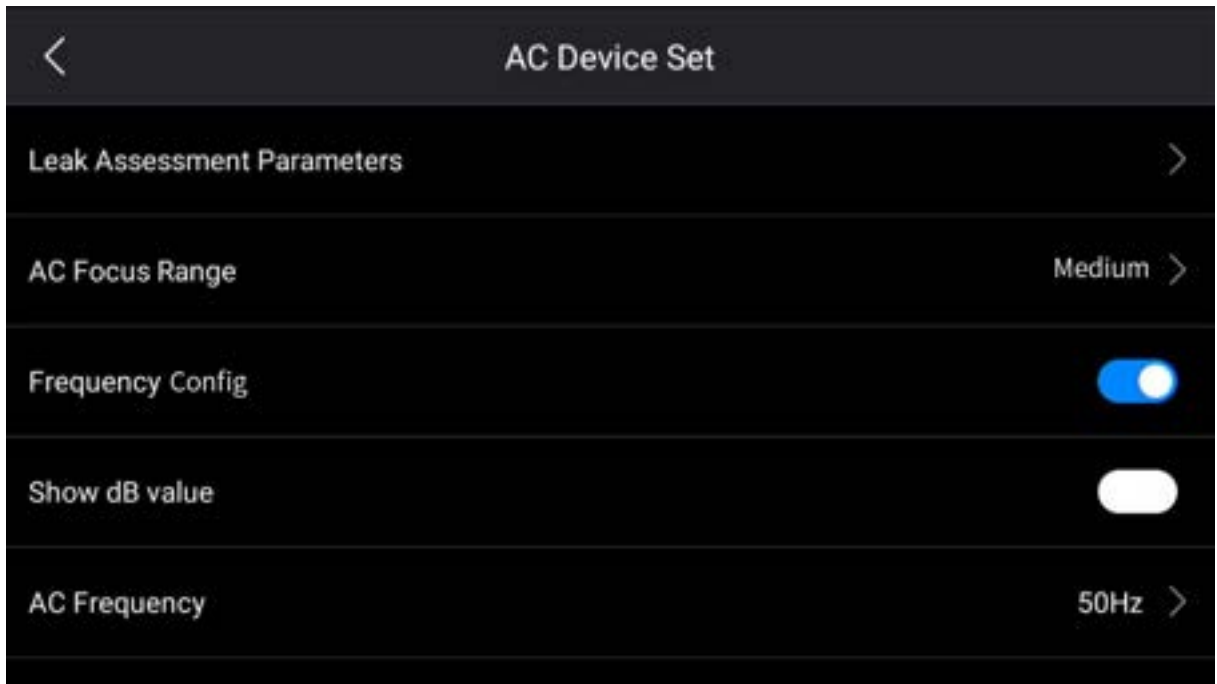

AC Device Set include: Leakage Evaluation Parameters, AC Focus Range, Frequency Set, Show dB Value, AC Frequency, SPL Normalization, and Menu Configuration;

4.7.1 Leak parameters

Leak Parameters	
Leak Correction Factor	1.00 >
Currency	USD >
Energy Cost(USD/kWh)	1.20 >
Gas Cost(USD/m ³)	0.00 >
Specific Power(kW/(m ³ /min))	7.00 >

Leak Parameters	
Energy Cost(USD/kWh)	1.20 >
Gas Cost(USD/m ³)	0.00 >
Specific Power(kW/(m ³ /min))	7.00 >
Unit	L/min >
Run Time (h/yr)	8640 >

Leak evaluation parameters include: leak correction factor, currency, energy cost, gas cost, specific power, unit, run time

4.7.2 AC focus range



AC focus range: large, medium, small (adjust the size of the focus frame)

4.7.3 Frequency config

Turn on frequency configuration to gain access to customizing the frequency range.

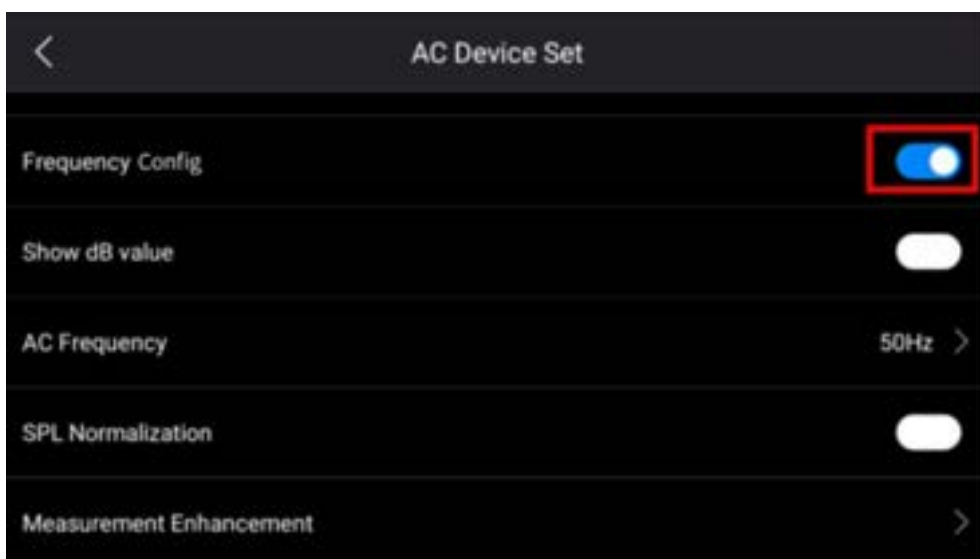

Once the 'Frequency Config' option is toggled, the button for adding customizing frequency span will appear on the main interface.



Users may manually select a range for the camera to narrow into and name the frequency range for later selection.





4.7.4 Show dB value

Whether the sound pressure value is displayed on the control screen

4.7.5 AC frequency

AC frequency can be selected from 50Hz, 60Hz

4.7.6 SPL normalization

Enable sound pressure level normalization to normalize the sound pressure level in PD mode and leak mode.

4.7.7 Measurement enhancement

Turning on and off signal linger mode (T-FFTD®) and measurement tools.



5.8 Plug-in settings

4.8.1 Plug-in manager

- Some business plug-ins can be customized or added under license based on recipe;
- On this interface, the user can choose to turn on/off the business plug-in. If the business plug-in is on, the corresponding logo appears on the left side of the main interface; otherwise, they won't appear.

5.8.2 Service plug-in

- The service plugin is a subsection of the IRExplorer

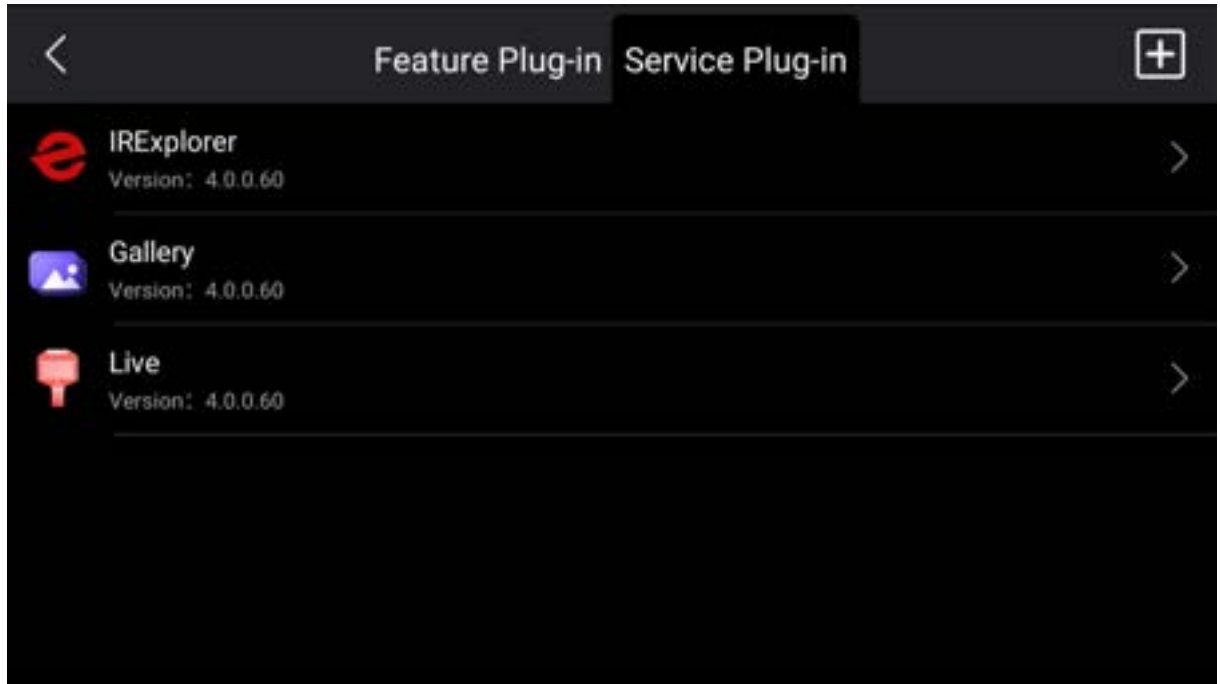

6 Image Freeze Interface

6.1 IR Mode



5.1.1 Favorite



1. Click on Follow Logo, the icon of Follow Logo appears in the top left corner of the image, click Save;
2. The gallery can be filtered by clicking on the attention markers for all image files with the attention markers.

5.1.2 Voice annotation

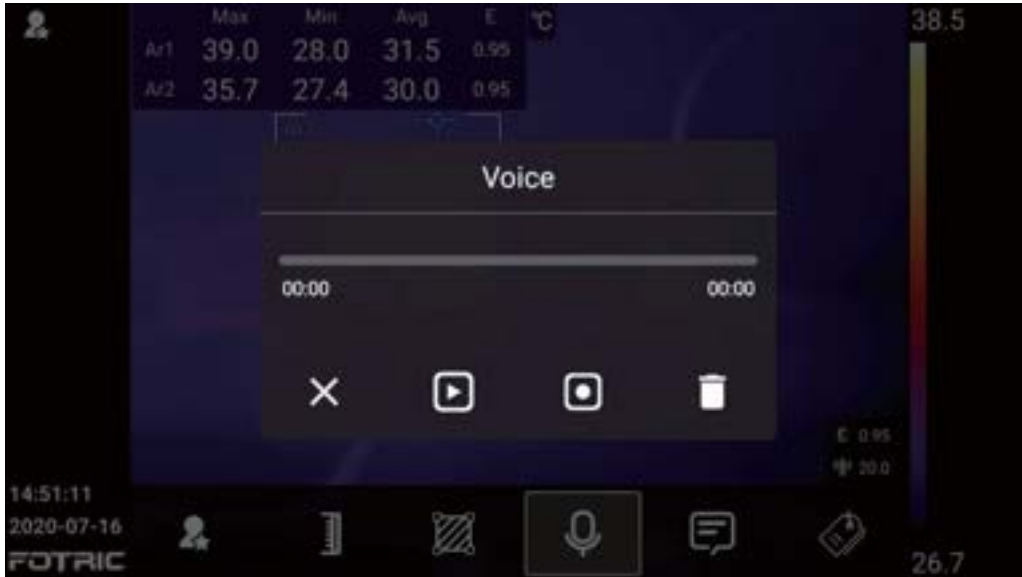

Voice Remarks supports 200s voice recording and is recorded in image files. It can be played in the image file or in the PC software.

 Close;

 Play;

 Recording;

 Delete.

5.1.3 Text annotation

 This icon is a text note button.

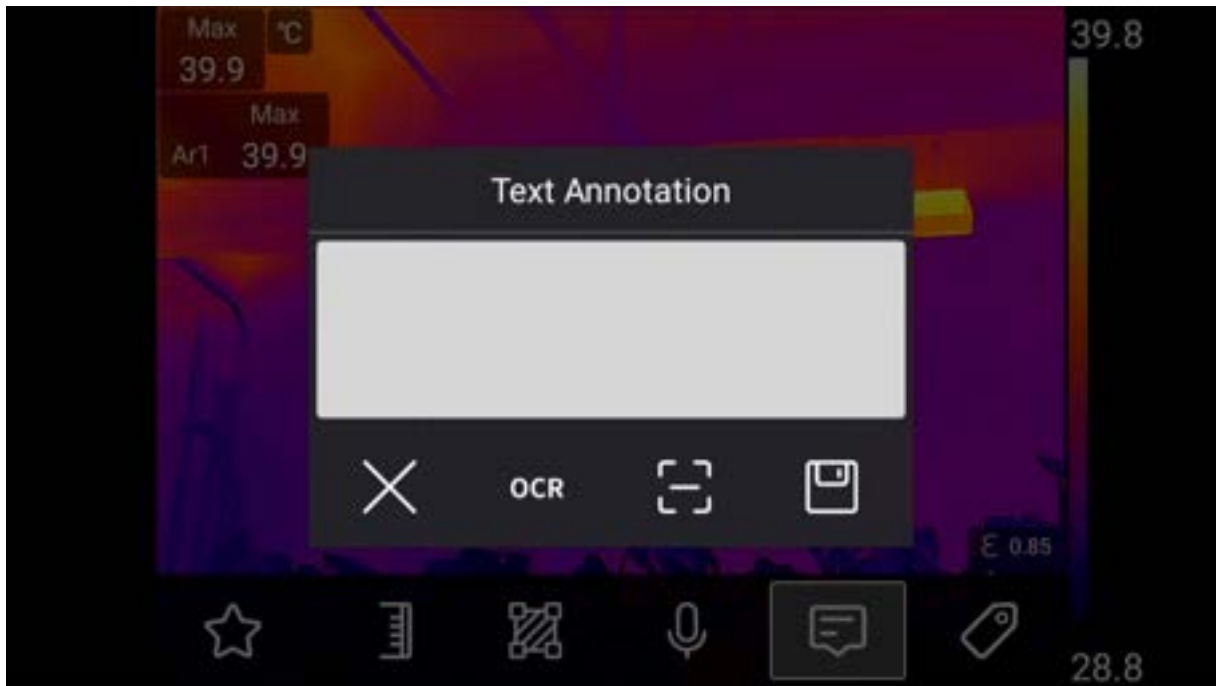

Users can add text notes to a thermal image file. When using this feature, users can add comments to the thermal image file by entering text information on the acoutherm imager's touchscreen keyboard or by voice.

 Close;

 OCR

 QR code scan

 Voice input;

 Save.

5.1.4 Keypad input

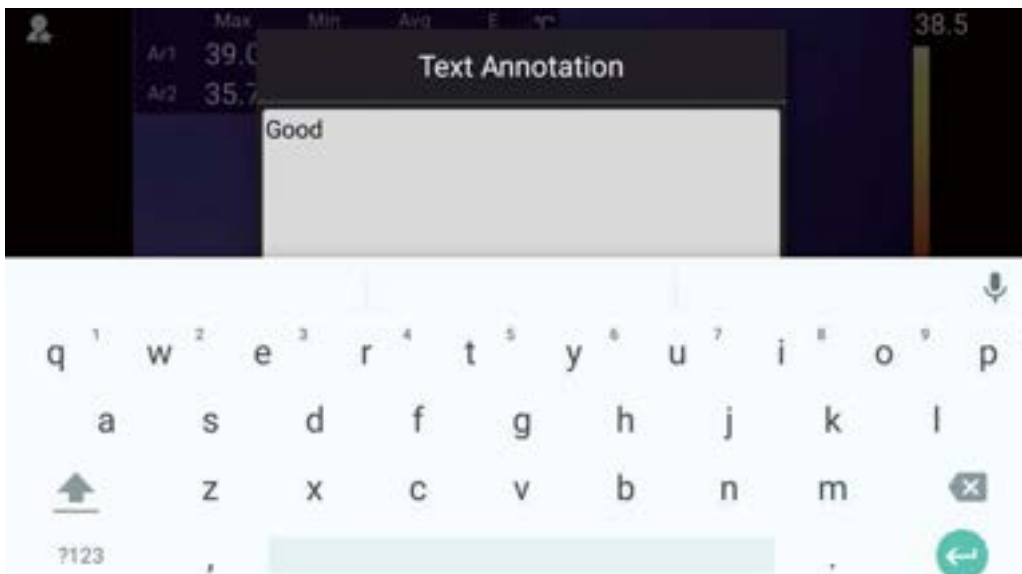

To add a text note using virtual keyboard input, please perform the following steps:

1. Tap the text box, the text input soft keyboard will pop up automatically under the touch screen, switch to the appropriate text input method;
2. After entering the text information to be commented, click on the area of the screen outside the text box to automatically exit the text input soft keyboard;
3. Clicking the Save button automatically saves the text message within the thermal image file.

5.1.5 Tag and auto-naming

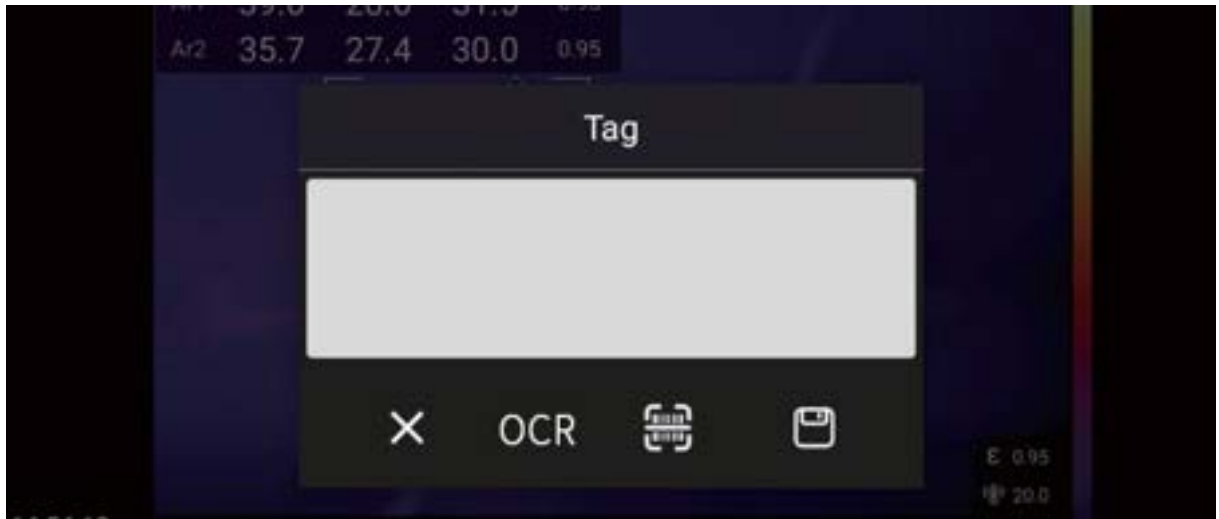

The label auto-naming function can be realized by means of QR code scanning, OCR text recognition, and manual keyboard input after on the freeze interface.

 Close;

 Text Recognition;

 QR code scanning;

 Save.

5.1.5.1 Keypad input

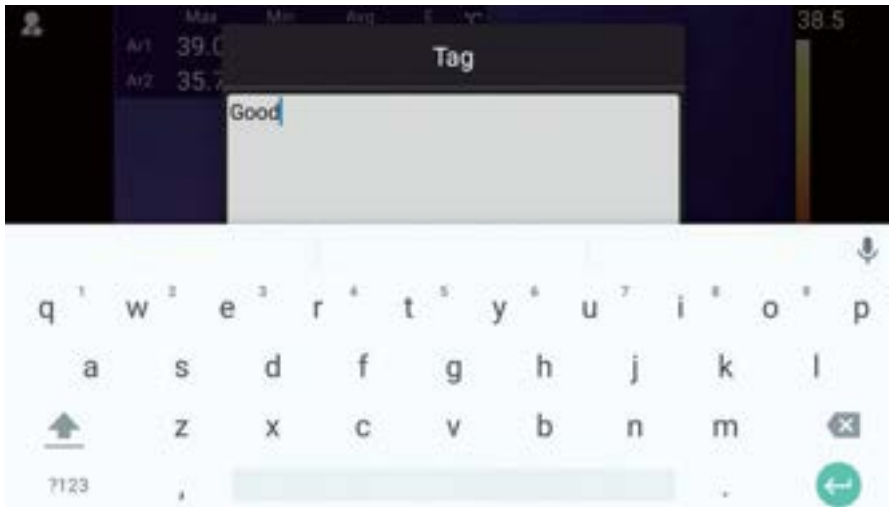

Click on the center blank space, the keyboard appears, enter the content and click OK to save it. The label logo appears in the upper left corner of the image.

5.1.5.2 OCR text recognition

Click  to access the text recognition.

1. Ensure that the acoutherm imager is connected to wifi;
2. Click  and align the middle box with the text to be recognized;
3. Tap the Take Picture button;

4. Click OK after recognition;
5. Click on the text to correct or add it via the keyboard;
6. Click Save, the content is saved and the label logo appears in the upper left corner of the image.

5.1.5.3 QR code scanning



Click  to access the QR code recognition function.



1. Click on  and align the QR code to be scanned;
2. Displays the content of the QR code;
3. Click Save, the content is saved and the label logo appears in the upper left corner of the image.

6.2 AC Images



6.2.1 Source mode



Sound source mode: Single;

Under this mode, the camera will only display the most prominent acoustic signal source.



Sound source mode: Multi;

Under this mode, the camera will display multiple prominent acoustic signal source as long as their strength passes certain threshold.

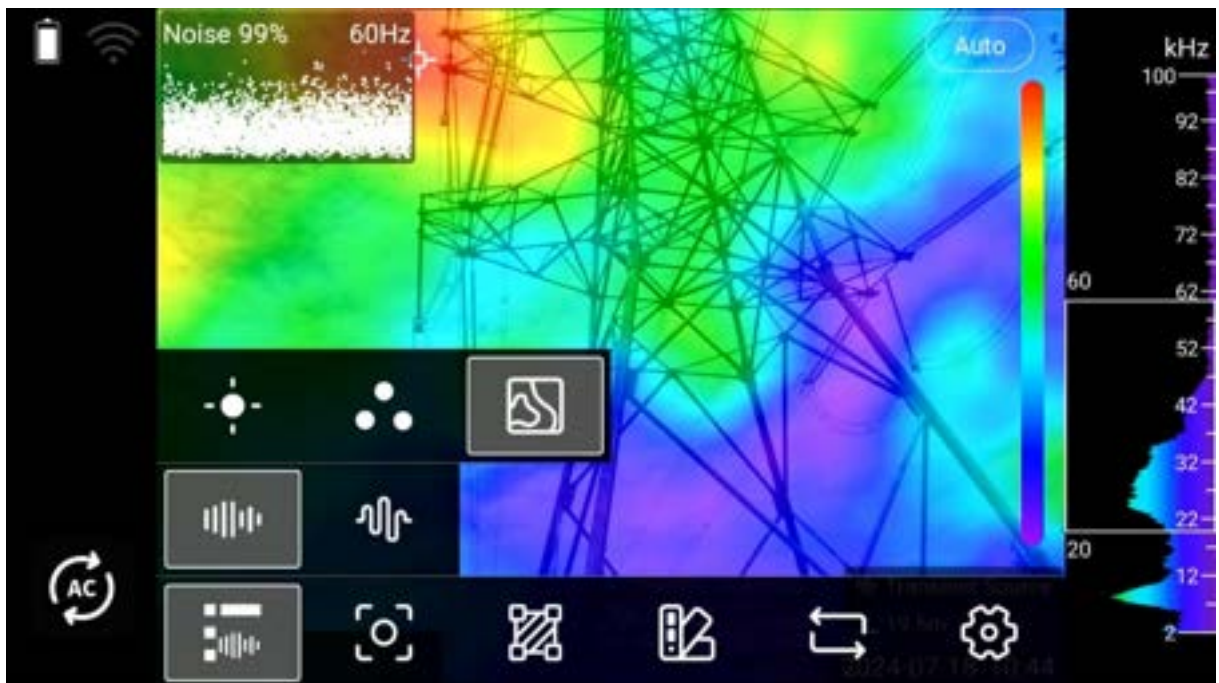

Sound source mode: Hologram.

Hologram mode will display the sound pressure level distribution on the screen. There are two sub display modes for hologram: auto and manual (please refer to the button on the top right corner of the screen). The auto mode will display the sound pressure level distribution of the entire screen. The manual mode will display the area where the signal strength exceeds a user-selected threshold.

Note: the number in manual mode (0.1~12) indicates how much lower the threshold is than the maximum point on the screen.

5.2.2 Measurement tools

Apply spots and circles.

Distance range: 0.3m~100m, can also be customized for manual input;



5.2.3 Favorite

Reference 5.1.1

5.2.4 Voice annotation

Reference 5.1.2

5.2.5 Text annotation

Reference 5.1.3

5.2.6 Tag

Reference 5.1.5

7 Gallery

Images are saved on the SD memory card, and all images that have been saved can be viewed through the gallery, which can be opened with the gallery button. The image files will be displayed in time group (day) as shown below. You can switch between images by pressing the Left/Right buttons, and the Up/Down buttons switch between up and down rows. To return to the live image, press the Back button.

Items in the gallery are selected the first time you click on them, and opened for analysis or playback when you click on them again.



Favorite;



Tag filtering;





Analysis;

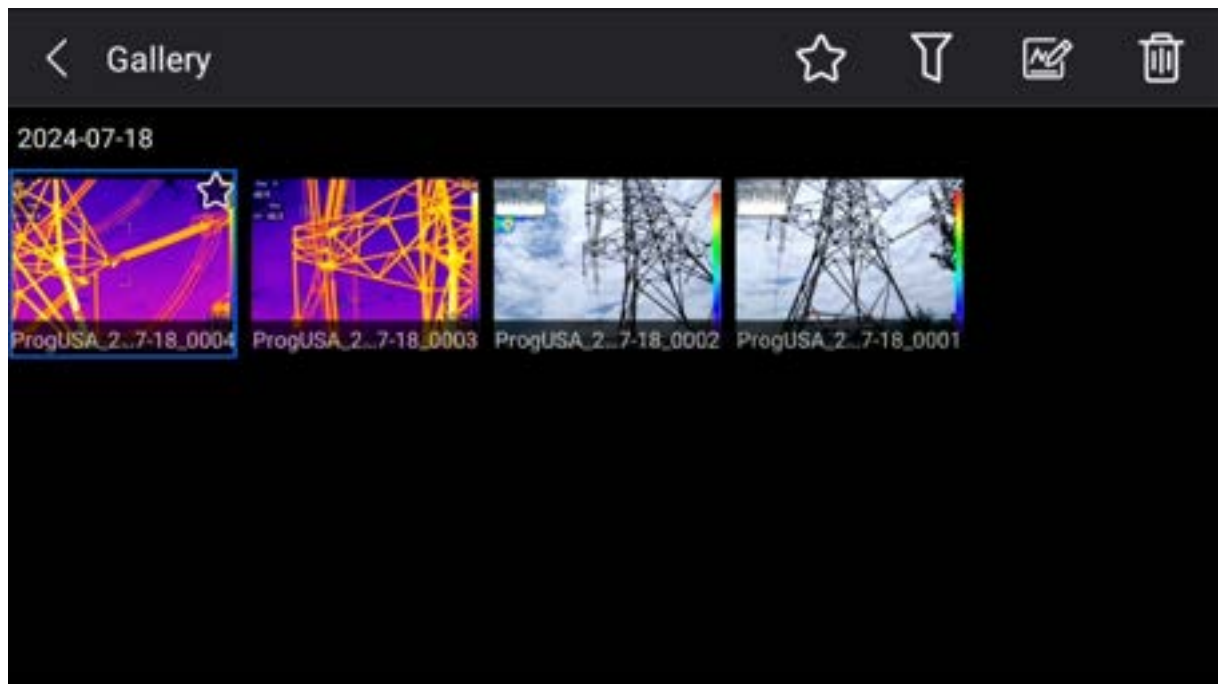

Delete.

7.1 Favorite



Click  to follow the logo

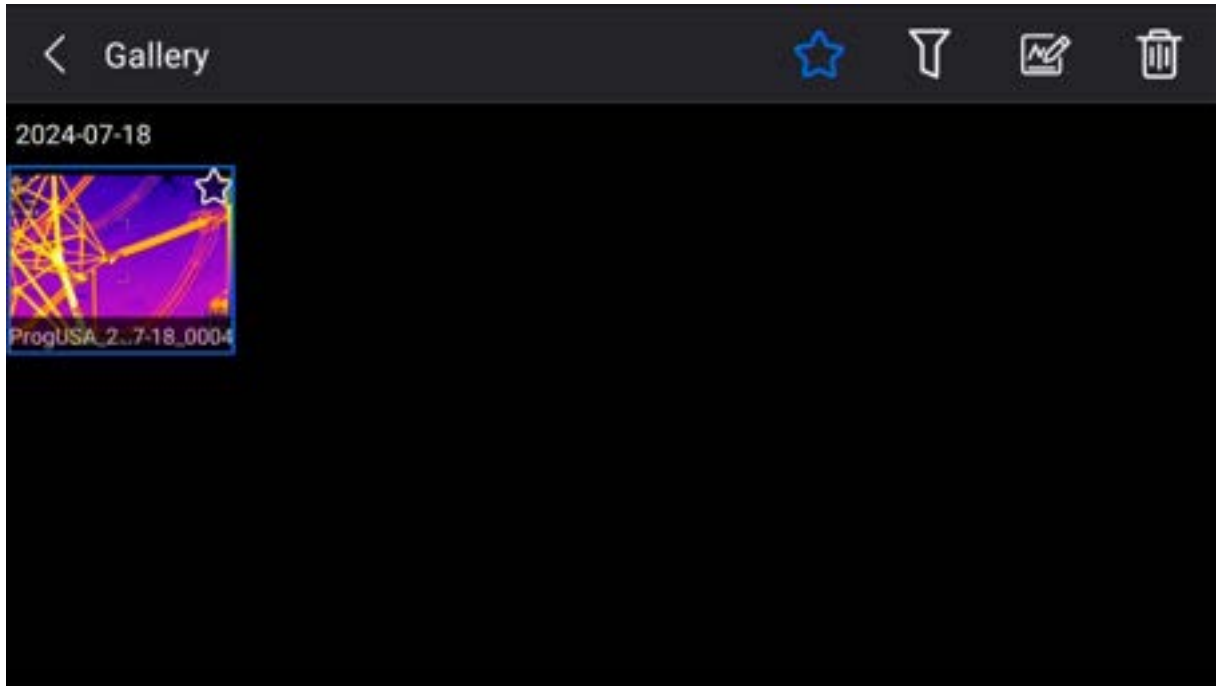

Directly filters out all documents with concern markers added. See 6.1 Concerns and Filtering for details on adding concern markers.

7.2 Filter

Click  to enter the label filtering interface.

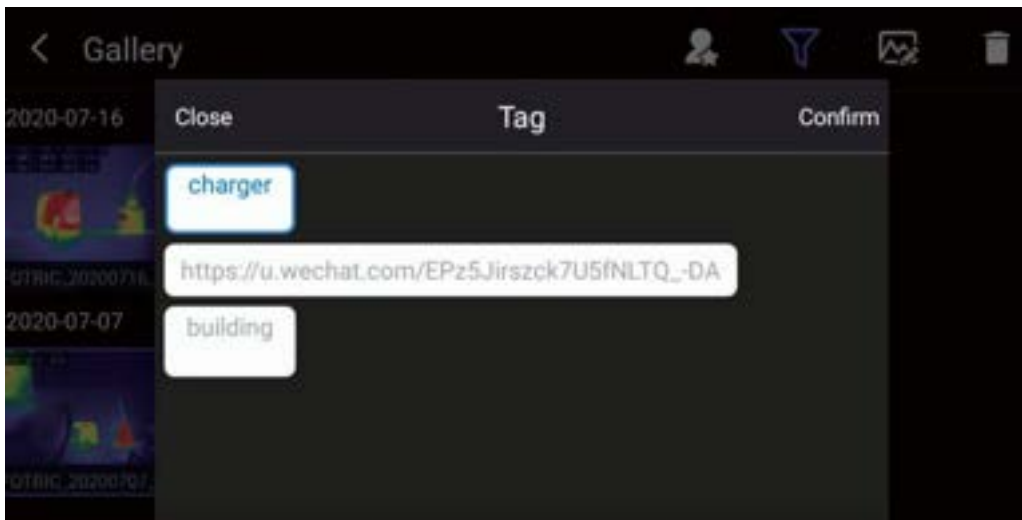

Select the tags that need to be filtered and click OK to filter out the files that have

this tag added. See 6.4 Labeling and Auto-naming for details on adding labels.

7.3 Open Image and Video Files

The image files in the gallery are divided into thermal image, visible light, video, and continuous image, in which the continuous image will be displayed as a group of one continuous image, the video file contains MP4 and IRS full radiation files, for thermal image can be opened again to analyze and edit and save the parameter modification, the IRS full radiation video file can be opened to analyze, the visible light and MP4 files can only be viewed and deleted, and cannot be edited. The visible and MP4 files can only be viewed and deleted, but not edited.



Select the file and click  to open the thermal image file and enter the analysis screen. Or open the thermal image file by doing the following:

1. The first click on a thermal image, picture-in-picture, or fusion image indicates that it is selected; clicking on it again opens the Analyze screen. Click "OK" button to pop-up menu (analyze, delete) to choose the operation;
2. Visible light for the first time to click that is selected, selected and then click to open the visible image to view, click "OK" button pop-up menu (view, delete) to choose the operation;
3. The first click on the IRS Total Radiation video file indicates that it is selected, and when it is selected and clicked again, it opens into the analysis interface, where temperature information can be viewed;
4. MP4 files are full-screen recorded videos that can be opened for playback;
5. Continuous shooting images, click to enter the connected image interface, you can view all the images under the current continuous shooting, you can

analyze and delete each image separately.

7.4 Thermal Image File Analysis

Single shot visible photos can be viewed only, for thermal image files, picture-in-picture files, and image fusion files open as follows:



Open the thermal image file in the gallery to enter the thermal image file analysis screen. Click  to open more functions.



Temperature Width Mode, see 4.5 Temperature Width Mode for details;



Measurement tools, see 4.8 ROI measurement tools for details;

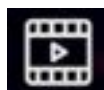

Image mode, switchable to thermal image, picture-in-picture, fusion;



Concern markers, see 6.1 Concerns and Screening for details;



Save;



More features;



Measurement parameters, see 4.6 Measurement parameter settings for details;



Color palette, see 4.10 Color palette for details;



Voice memo, see 6.2 Voice memo for details;



For textual remarks, see 6.3 Textual remarks;



labels, see 6.4 Labeling and Automatic Naming for details;



Details, click to open the details.

7.5 Thermal Video Analysis

MP4 video files can only be played, for .IRS video files open as follows:



Play, click to play the video;



Temperature Width Mode, see 4.5 Temperature Width Mode for details;



Measurement tools, see 4.8 ROI measurement tools for details;



Measurement parameters, see 4.6 Measurement parameter settings for details;



Color palette, see 4.10 Color palette for details;

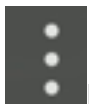

More features;



Voice memo, see 6.2 Voice memo for details;



For textual remarks, see 6.3 Textual remarks;



Details, click to open the details.

7.6 Deleting an Image or Video File

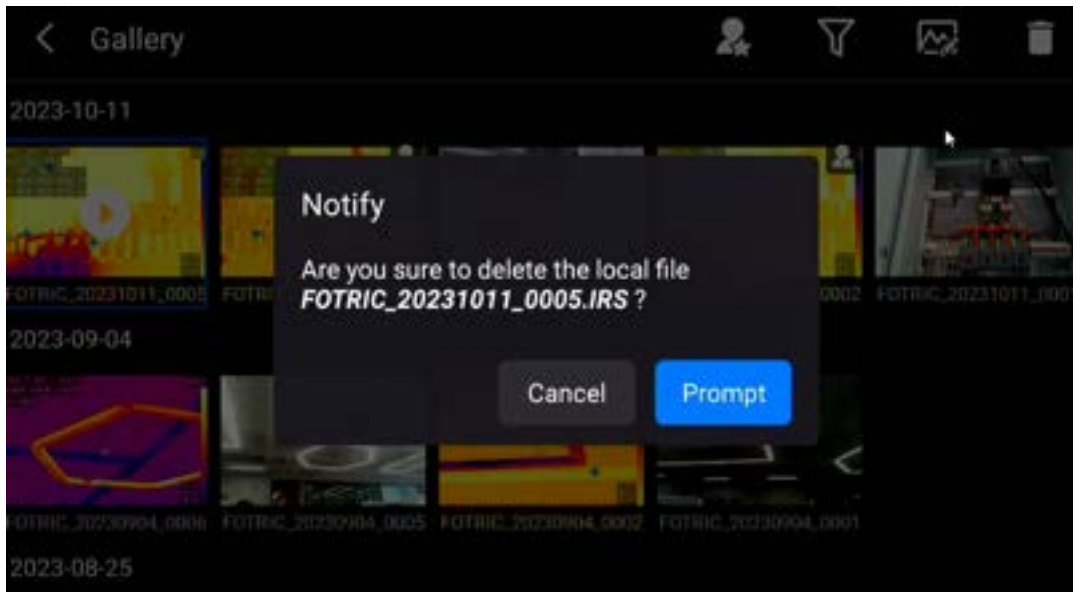

1. Press the button for the "Gallery" function to open the gallery;
2. The gallery will list all files in a thumbnail list, grouped by shooting date;
3. Select any gallery, click "Delete" button or press "OK" button to pop up the operation menu, select "Delete" to delete the corresponding image file;
4. Click OK.

7.7 Delete Multiple Files

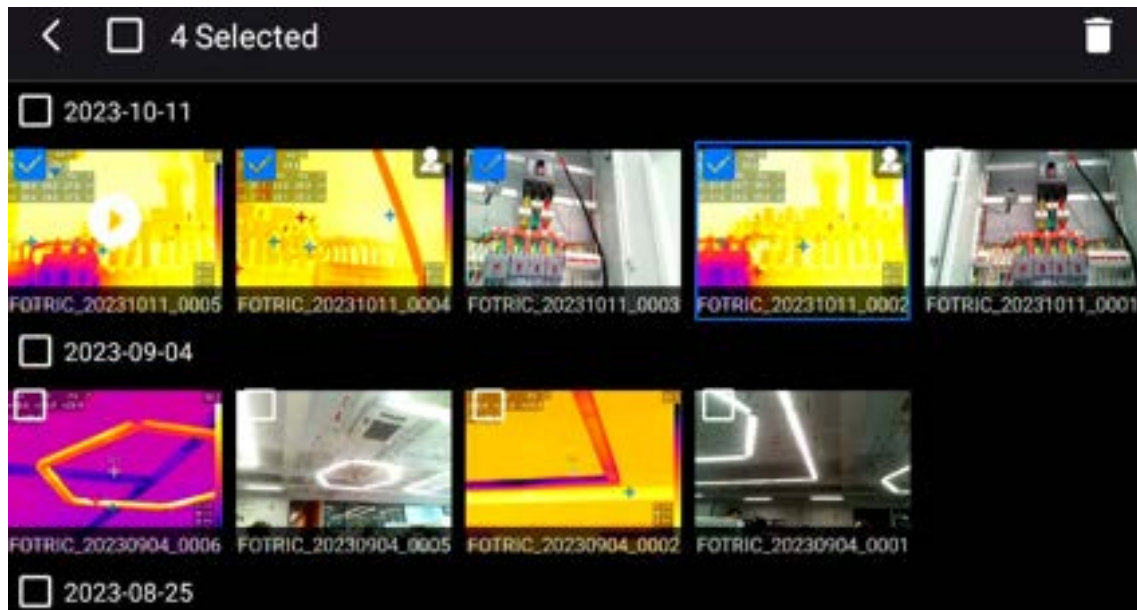

1. Long press one of the thumbnails, you can enter the multi-select state, in the multi-select state you can select more than one file and then click delete, you can delete more than one file;
2. Click Delete - OK to delete the selected file.

8 Camera Maintenance

8.1 Cleaning the Camera Case, Cables and other Components

Cleaning Procedures

Please use a soft cloth and pure water/Non-irritant cleaning liquid to clean.

Note: Please don't apply corrosive or similar liquid on the Imager, cable or other parts. It might cause damages.

8.2 Cleaning the infrared lens

8.2.1 Solvent

The following liquids can be used:

1. Commercial lens cleaning solutions with isopropyl alcohol concentrations greater than 30%;
2. 96% concentration of ethanol (C₂H₅OH).

8.2.2 Notes

1. Lens cleaning cotton pad is a disposable item; do not reuse it.
2. Please be careful when cleaning the infrared lens. The lens has a precise anti-reflective coating.
3. Do not use excessive force to clean the infrared lens. This might damage the

anti-reflective coating.

8.3 Cleaning Uncooled Infrared Focal Plane Detectors

The presence of even a small amount of dust on an uncooled infrared focal plane detector can result in significant image imperfections. To remove dust from the detector, follow the steps below.

! Attention:

1. This section applies only to acoutherm imagers where removal of the lens exposes the uncooled infrared focal plane detector;
2. In some cases, dust on the surface of uncooled infrared focal plane detectors must be cleaned mechanically;
3. This mechanical cleaning operation must be carried out by the FOTRIC after-sales service department or by a service partner authorized by FOTRIC.

Cleaning Procedures

Please follow the steps below:

1. Remove the lens from the acoutherm imager;
2. The compressed air produced by rubber bulb syringe can be used to blow off the dust on the surface of the uncooled infrared focal plane detector.

! NOTE: In step 2, do not use compressed air from pneumatic circuits in, for example, a workshop, because this air usually contains oil mist which can damage the

detector surface.

8.4 Lithium Battery Maintenance

1. Do not expose the Battery close to heat sources or high-temperature environments, such as unattended vehicles in the direct sunlight.
2. Do not disassemble or squeeze the battery and battery pack.
3. Take out the battery from device when not use for long term.
4. Keep the battery and battery pack clean and dry.
5. Use only the power adapter approved by FOTRIC to charge the battery..

! CAUTION: To prevent damage, do not expose the product to heat or high temperatures (e.g., unattended vehicles in the sun).

9 Glossary

Absolute zero.

means -273.15°C ($0\text{ Kelvin} = 459.69^{\circ}\text{F}$). Absolute zero is a completely ideal state in which the motion of the atoms of an object stops completely, i.e., at this temperature the object is completely devoid of any energy.

Kelvin [K]

One of the internationally recognized temperature scales. 0 K corresponds to absolute zero (-273.15°C).

See the following conversion formula: $273.15\text{ K} = 0^{\circ}\text{C} = 32^{\circ}\text{F}$. $\text{K} = ^{\circ}\text{C} + 273.15$.

Celsius degrees Celsius [$^{\circ}\text{C}$]

Degrees Celsius is a temperature scale that is currently more widely used in the world. Under 1 standard atmospheric pressure, the boiling point of water is defined as 100°C , and the freezing point of water is set at 0°C , between which it is divided into 100 equal parts, and 1 equal part is 1°C .

$^{\circ}\text{C} = (^{\circ}\text{F} - 32) / 1.8$ or $^{\circ}\text{C} = \text{K} - 273.15$

Fahrenheit temperature [$^{\circ}\text{F}$]

It is a temperature scale that is more widely used in North America. $^{\circ}\text{F} = (^{\circ}\text{C} \times 1.8) + 32$.

Infrared radiation

It is a type of electromagnetic radiation. Any object above absolute zero emits

infrared radiation.

Absorption

Any object has the ability to absorb infrared wavelengths to a greater or lesser extent, and the most direct reflection of the object after absorbing infrared light is an increase in temperature. Usually the object with relatively high temperature radiates more energy than the object with lower temperature, while for the object itself, the absorbed infrared energy will be converted into its own energy and radiate to the outside, therefore, the emissivity of the object is related to the absorption rate of the object.

Radiation

In nature, all the temperature in the absolute zero degrees above the object, are in the form of electromagnetic waves constantly transmit heat to the outside, this way of transmitting energy is called radiation .

Conduction

Heat is always transferred from an object of higher temperature to an object of lower temperature in a process called heat conduction. Heat conduction is the main mode of heat transfer in solids.

Convection

The process of heat transfer that relies on the flow of the fluid (liquid, gas) itself is called thermal convection, or convection for short, and convection is caused by temperature inhomogeneity.

Atmospheric windows

When solar radiation passes through the atmosphere, the range of wavelengths of light radiation with high transmittance that are not reflected, absorbed or scattered is called the "atmospheric window". An atmospheric window also exists in the infrared wavelength range, where there is a stable atmospheric transmittance in the 7-14 μm range. Therefore, measurements using infrared technology are particularly effective in this wavelength range.

Black body radiator

A blackbody radiator is an object that absorbs all of the incident electromagnetic waves and converts all of them into its own energy to radiate outward, with no reflection or transmission in the process. The emissivity of blackbody radiator $\epsilon = 1$, there is no such absolute blackbody in the real nature, blackbody radiator is regarded as a kind of ideal object, usually used as a standard object for thermal radiation research. Most blackbodies are also set to an emissivity of < 1 for calibration or alignment purposes, usually set to $\epsilon > 0.95$.

Grey body radiator (real body)

The vast majority of objects in nature are "gray radiators". Unlike black bodies, gray bodies cannot absorb so incident light waves, and usually reflect or conduct both at the same time. The emissivities of gray radiators are all values between 0.1 and 1.0.

Coloured body radiator

Colored emitters are materials whose emissivity varies with wavelength and temperature. This means that the same object has different emissivities. Most metals are colored emitters, e.g., aluminum increases in emissivity when heated.

Thermal Imager

An infrared thermal imager is a detection device that is capable of detecting radiation in the infrared band of the electromagnetic wave spectrum and turning invisible infrared radiation into a visible picture. The most important functions of the thermal imager at present are temperature measurement and imaging.

Detector

The sensor of an infrared thermal imager detects the infrared radiant energy of an object and converts it into an electrical signal. The smallest unit of the detector is a pixel.

Focal Plane array Non-cooling Focal Plane Infrared Detector (FPA)

FPA detectors were early refrigerated detectors and were large in size and used for measurements in the near-infrared band; nowadays, FPA detectors have been developed into uncooled types and are used for high-precision measurements in the far-infrared band. The detector receives the radiant energy from the object and causes the sensor temperature to rise, thus changing the resistance value of the sensor, which is expressed by an electrical signal. There are two types of FPA sensors: optical readout uncooled focal plane arrays and electrical readout uncooled focal plane arrays, which are used to measure the temperature of the sensor and the

temperature of the sensor.

Refresh rate

Expressed in Hertz, this refers to the rate at which the acoustic/thermal imager updates the image per second. For example, 30Hz means that the camera can update 30 complete thermal images in one second.

Resolution

Resolution is a parameter used to measure how much data is within an image, and refers to how many dots (pixels) there are per unit length.

Lens

The lens determines the size of the range of the visible field of view of the thermal imager. Wide angle lenses are suitable for a large field of view of the temperature field distribution, while telephoto lenses are suitable for detailed measurements at long distances. Commonly used lens materials are germanium (Ge), silicon (Si) and zinc selenide (ZnSe), which are excellent materials with good infrared transmission.

Field of view (FOV)

FOV is the horizontal and vertical angle at which an object is fully imaged in a thermal imager.

MFOV Measurement of Field of View

MFOV is the smallest range of pixels over which a thermal imager detector can accurately measure data. There are two main types: MFOV=1 and MFOV=3×3=9.

Thermography

The use of infrared thermal imagers displays a map of the surface temperature field by means of non-contact measurements. The thermal imager creates a visual image of the thermal distribution by detecting the amount of radiant energy of an object, converting it according to the relationship between radiant energy and temperature, and displaying the temperature values in the field of view of the shot in different colors. Each pixel of the thermal imager represents a temperature point on the surface of the object being measured.

Measuring range

The temperature measurement range is the band of temperatures that can be measured by the thermal imager, indicating the amount of thermal radiation that can be measured and recorded by the instrument. Usually a maximum and a minimum limit are specified, which are indicated by the two bolded temperature values that limit the current calibration. Outside the defined measurement range, the instrument will usually fail to display or guarantee the accuracy of the measured values.

Thermal sensitivity NETD

NETD is the thermal sensitivity of infrared thermal imager (also known as noise equivalent temperature difference), describes the minimum temperature difference that can be detected by the instrument, which is directly related to the clarity of the thermal imager's measurements, the smaller the value of thermal sensitivity, indicating that its sensitivity is higher and the image is clearer.

Accuracy

It refers to the degree of proximity between the observed results, calculated or estimated values and the reference values. For example, if the actual surface temperature is 100°C and the measurement accuracy is $\pm 2^\circ\text{C}$, the difference between the measured value and the actual measurement result will not exceed $\pm 2^\circ\text{C}$, i.e. 98°C-102°C.

Calibration

Calibration is the process of comparing the actual measured value of an instrument with the value of a standard, the result of which indicates that the measurement accuracy of the instrument is within the permissible limits. Calibration is different from calibration in that it is meant to record the deviation of an instrument's value, not to correct its measurement results. The calibration intervals and timeliness of an instrument depend on the measurement task and requirements.

Colour palette

Palette sets the color display of the image. Set the contrast of the image display colors according to different measurement tasks.

Isotherms isotherm

Temperature ranges can be set and all identical temperature points within this range are marked with the same color. This analysis function assists with on-site analysis.

Coldspot and Hotspot

In acoustic thermography, the point with the lowest temperature is called the

"cold spot" and the point with the highest temperature is called the hot spot.

Emissivity (ϵ)

Emissivity Epsilon: The emissivity is the ratio of the energy radiated outward by the object under test to the energy radiated by a blackbody at the same temperature and wavelength. The value of ϵ is a material property of the object under test, and is related to the properties of the surface of the object under test, as well as to the temperature and wavelength of the object under test. The value of ϵ is a material property of the object under test.

RTC (Reflected Temperature Compensation)

Some objects have quite high reflectivity, and in addition to taking care to adjust the emissivity of these objects under test when measuring, it is best to correct the measurement results by entering the temperature value of the high radiation source affecting the object under test in order to minimize the measurement error and improve the accuracy of the measurement results.

Condensation

It is the process of conversion from a gaseous state to a liquid state. When the surface temperature of an object is lower than the ambient temperature of the air, the moisture in the air will condense into water droplets on the surface of the object, and at a certain temperature, the original unsaturated water vapor contained in the air becomes saturated, and this temperature point is also called the dew point.

Dewpoint

Dew point is short for dew point temperature, dew point temperature is the atmospheric pressure is unchanged, due to the cooling effect, the air originally contained in the unsaturated water vapor becomes 100% saturated temperature, known as the dew point temperature.

Relative humidity

The absolute humidity of air at a given temperature as a percentage of the saturation vapor pressure of water at the same temperature.

Specular reflection

Specular reflection usually occurs on surfaces with high reflectivity or low emissivity. However, specular reflection does not mean that the object has high reflectivity, e.g., painted surfaces, where acoustic thermography can reflect the specular reflection of other ambient emitters (e.g., measuring the image of a person) on painted surfaces, which generally have a high emissivity ($\epsilon \approx 0.95$). Conversely e.g. sandstone walls, which have lower emissivity ($\epsilon \approx 0.67$), are unable to form specular reflections. Therefore, the surface structure of an object is an important factor affecting specular reflection. Specular reflection is the phenomenon that when the incident light is a parallel ray, it is reflected to a smooth mirror surface and goes out as a parallel ray. Its relative concept is diffuse reflection, which refers to the incident light is parallel to the light, reflected to the rough object, the reflected light in all directions out of the phenomenon. For example, when aluminum foil is flat, it is easy to produce specular reflection, but when the foil is crumpled and then unfolded, the

uneven surface produces diffuse reflection, which is different in all directions on the surface of the object.

Reflectance coefficient (ρ) [rəʊ]

is the ability of an object to reflect infrared radiation. ρ depends on the type of material, the nature of the surface and the temperature and wavelength. In general, smooth and polished surfaces have a higher reflection coefficient, while rougher and non-glossy surfaces have a lower reflection coefficient.

Transmittance Transmission coefficient (τ)

Refers to the ability of a substance to transmit infrared radiation. τ (tao): depends on the type and thickness of the material.

Coefficient of Convective Heat Transfer

Its size reflects the strength of convective heat transfer, which is defined as: when the temperature difference between the fluid and the solid surface is 1K, 1 square meter of surface area in the heat transfer per second, expressed in h. The heat transfer is the same as the convection heat transfer, which is the same as the convection heat transfer.

Kirchhoff's radiation law Kirchhoff's radiation law

is a well-known law of thermodynamics that describes the relationship between the emissivity and the absorption ratio of an object of a certain wavelength: under conditions of thermal equilibrium, the absorption ratio of an object to thermal radiation is constantly equal to the emissivity at the same temperature.

Planck's radiation law

Planck's Law of Radiation presents the idea that the intensity of the electromagnetic energy emitted by a blackbody depends on the wavelength and frequency. Planck's law was born in 1900 and is considered the fundamental theory of quantum physics. Currently Planck's constant is the most important physical constant in modern physics, and Planck's law is also the physical basis for the development of infrared acoustic and thermal imagers. At the beginning of Planck's research, it is assumed that the emission and absorption of light (i.e., later electromagnetic radiation) is not continuous, but a copy of a copy of a copy of a copy of a copy of its calculations in order to match the results of the test, such a copy of the energy is called the quantum of a copy of a copy of the quantum is equal to $h\nu$, ν for the frequency of the radiation of electromagnetic waves, h is a constant, called Planck's constant.

Stefan-Boltzmann-law Stefan Boltzmann's Laws

The famous law of thermodynamics, the law proposes that the total energy of electromagnetic waves of various wavelengths radiated per unit area of the surface of a blackbody per unit time is proportional to the fourth power of the thermodynamic temperature of the blackbody itself, T , with the formula $W_b = \sigma \cdot \epsilon \cdot T^4$

where σ (sigma) = $5.67 \times 10^{-8} \text{W}/(\text{m}^2\text{-K}^4)$ is the Steffen-Boltzmann constant;

10 History of Thermal Imaging

Infrared light was discovered in 1800 by the Royal Astronomer (Friedrich Wilhelm Herschel) while searching for a new optical medium.

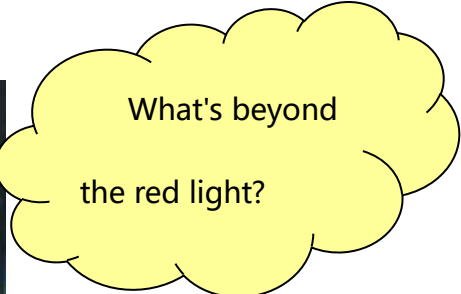

Figure 1. Herschel (1738-1822)

Infrared is one of the most widespread types of electromagnetic radiation found in nature, and its electromagnetic spectrum is the region between visible light beyond the red and microwaves, so it cannot be viewed directly by our naked eye.

So how do we test for invisible infrared radiant energy?



As early as 1840, William John Herschel, son of Sir William Herschel, produced the world's first so-called "thermogram" on a thin oil film. Herschel, the son of Sir William Herschel, produced the world's first so-called "thermogram" on a thin film of oil, making it

possible to test for thermal radiation.

Another major breakthrough was made in 1880 by an American, Samuel Pierpont Langley, who invented the radiometric thermometer. The instrument was said to be able to measure thermal radiation from cattle up to 400 meters away.

Figure 2. Samuel Pierpont Langley (1834-1906)

The first infrared heat detection systems in the modern sense were developed during the First World War from 1914-1918. In the Second World War from 1935-1945, the Germans used the infrared transducer as a photoelectric conversion device to develop active night vision and infrared communication equipment, laying the foundation for the development of infrared technology.

After World War II, the first generation of passive infrared imaging devices for military use, known as infrared forward-looking systems, were developed by the U.S. Dexaram Instruments Corporation after nearly a year of exploration. During this period, the rules of military secrecy completely prevented the leakage of the state of infrared thermal imaging development. This classified technology was not made public until the 1950s, and only later, with the development of indium antimonide and germanium-doped mercury photon detectors in the 1950s, did systems begin to appear for high-speed scanning and real-time display of thermal images of targets.

11 Principles of Thermal Imaging

11.1 Summary

Infrared radiation and its associated thermal imaging technology is still an unfamiliar topic to most users who will be working with infrared thermal imagers. In this section, we will explore with you the principles behind thermal imagers.

11.2 Electromagnetic Spectrum

There is a wide variety of electromagnetic radiation in nature, each with a different wavelength and vibration frequency, and together they make up the electromagnetic spectrum. Visible light, which is perceived by the human eye, is only one part of the spectrum. In addition, we are more familiar with visible light, infrared, ultraviolet, X-rays, radio waves and so on.

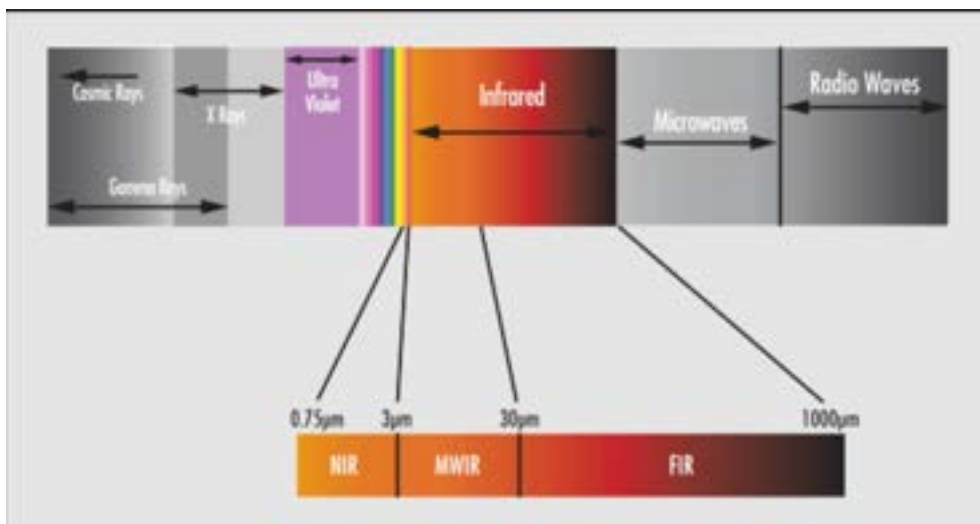

spectrogram of electromagnetic radiation

The electromagnetic spectrum can be arbitrarily divided into many wavelength ranges, which are called "bands". From the electromagnetic spectrum, it can be seen

that the human eye can perceive the wavelength band of light from 380nm to 780nm, while the wavelength band of infrared light is from 780nm to 1mm.

11.3 Infrared Light

Infrared light is emitted by objects above absolute zero themselves, so it is safe.

Infrared light can be divided into four smaller bands depending on the field of application, and their boundaries can be chosen arbitrarily.

Near-infrared band: 0.75 μ m-3 μ m

Mid-infrared band: 3 μ m-6 μ m

Far infrared band: 6 μ m-15 μ m

Extreme far infrared band: 15 μ m-1000 μ m

Therefore, different wavelengths of thermal imagers should be selected for different bands of infrared testing. Currently, the most commonly used thermal imaging cameras in the commercial field are the 7 μ m-14 μ m long-wave thermal imager and the 3 μ m-5 μ short-wave thermal imager, as well as some thermal imagers for special applications.

Why do thermal imagers make such infrared band divisions?

We need to know that solar radiation is transmitted to the earth because of the atmospheric window, with which some of the sun's radiation can reach the earth and life on earth can exist.

11.4 Atmospheric Window

The so-called atmospheric window is the range of wavelengths of electromagnetic

radiation with high atmospheric transmittance that are not reflected, absorbed or scattered by solar radiation as it passes through the atmosphere.

Similarly, there are atmospheric windows in the infrared wavelengths, with stable atmospheric transmittance in the 1µm-3µm, 3µm-5µm, and 7µm-14µm ranges, and therefore the results of thermal imaging measurements in these wavelengths are especially pronounced.

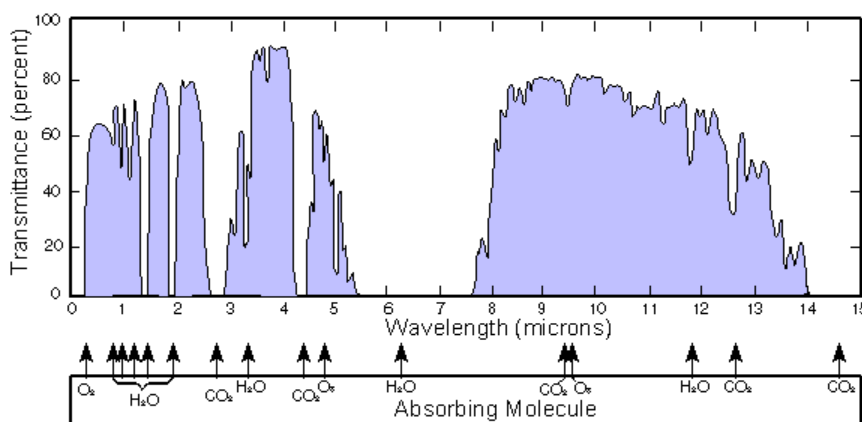

Infrared Atmospheric Window Diagram

11.5 Black Body Radiation (in thermodynamics)

A blackbody is an object that absorbs all radiation that strikes it at any wavelength. Relating to the object emitting the radiation

The term "blackbody" was elaborated by Kirchhoff's law (named after Gustav Robert Kirchhoff, 1824-1887).

(b) A clear indication that an object capable of absorbing all radiation at any wavelength is equally capable of emitting radiation.

If the temperature of the blackbody radiation is raised above 525°C, the source

begins to become visible to the naked eye and therefore no longer appears black to the human eye. This is the initial red-hot temperature of the radiating body, which then changes to orange or yellow as the temperature increases further. In practice, the so-called color temperature of an object refers to the temperature to which a black body must be heated to achieve the same appearance.

Let us now examine together the two equations that describe the radiation emitted by a blackbody.

11.6 Planck's Law



Max Planck (1858-1947) Max Planck (1858-1947)

Max Planck (1858-1947) used the following equation to describe the spectral distribution of blackbody radiation:

$$W_{\lambda b} = \frac{2\pi hc^2}{\lambda^5 \left(e^{\frac{hc}{\lambda kt}} - 1 \right)} \times 10^{-6} [\text{Watt/m}^2, \mu\text{m}]$$

$W_{\lambda b}$: Blackbody spectral emissivity at wavelength λ ;

C: Speed of light = 3×10^8 m/s;

h: Planck's constant = 6.6×10^{-34} Joule seconds;

k: Boltzmann's constant = 1.4×10^{-23} Joules/K;

T: Absolute temperature of the blackbody (K);

λ : wavelength (μm);

! Note: The factor 10^{-6} is used because the spectral emission in the curve is expressed in $\text{Watt}/\text{m}^2, \mu\text{m}$.

A series of curves can be obtained by plotting various temperatures according to Planck's formula. In any Planck curve, $\lambda = 0$ at the spectral emissivity is zero, when the wavelength is λ_{max} , the spectral emissivity increases rapidly to the maximum value, and then converges to zero at long wavelengths. The higher the temperature, the shorter the wavelength at which the maximum occurs.

Blackbody spectral radiances plotted at different absolute temperatures according to Planck's law.

1: Spectral radiance ($\text{W}/\text{cm}^2 \times 10^3 (\mu\text{m})$); 2: Wavelength (μm)

11.7 Stephen Boltzmann's Law

By integrating Planck's formula from $\lambda = 0$ to $\lambda = \infty$, we derive the total blackbody radiance (W_b):

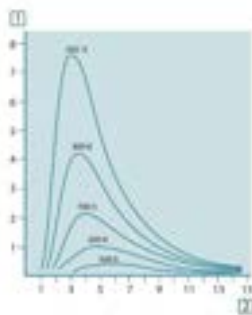

$$W_b = \sigma \cdot \epsilon \cdot T^4$$

$\sigma = 5.67 \times 10^{-8} \text{ W}/(\text{m}^2 \cdot \text{K}^4)$ is the Stephan-Boltzmann constant;

Emissivity (ϵ) = a value between 0.1 and 1.0;

Temperature (T) = the true temperature of the object;

The higher the temperature of an object, the more energy it radiates.

The above is the Steven Boltzmann formula, which clarifies that the total emitted power of a blackbody is proportional to the fourth power of its absolute temperature.

W_b represents in the graph the area below the Planck curve at a given temperature. It can be seen that the emissivity in the region $\lambda= 0$ to λ_{max} is only 25 % of the total emissivity, indicating the approximate solar radiation located in the visible spectral range.



Josef Stefan (1835-1893) & Ludwig Boltzmann (1844-1906)

Joseph Stephan (1835-1893) and Ludwig Boltz (1844-1906)

12 Material Emissivity Table

Aluminum (rough)	0.07
Aluminum (weathered)	0.83

brick	0.81
carbon (chemistry)	0.95
concrete	0.95
Copper (oxidized)	0.78
Copper (polished)	0.05
fiberglass	0.97
foundry iron	0.64
Iron (rust)	0.69
oaken	0.90
Oil film 0.03 mm	0.27
Oil film 0.13 mm	0.72
Oil (thick)	0.82
paintwork	0.94
classifier for documents, letter etc.	0.90

plaster cast (for a broken bone)	0.86
Rubber (black)	0.95
human skin	0.98
dry soil	0.92
Soil (with saturated water)	0.95
Stainless steel (oxidized)	0.85
Stainless steel (polished)	0.14
Steel (oxidized)	0.79
Steel (polished)	0.07
distilled water	0.96
Water (cream)	0.98
Water (snow)	0.85

13 How to Set Emissivity

An infrared thermal imager transforms the invisible infrared energy emitted by an object into a thermal image that can be analyzed. The different colors on the thermal image represent the distribution and elevation of the surface temperature of the object being measured.

The infrared radiation received by the thermal imager includes the radiation emitted by the object under test itself, the reflection from the environment, and possibly the transmitted energy. Only the thermal radiation energy emitted by the target under test itself can truly reflect the true temperature of the target surface.

According to the measurements with non-blackbody radiation sources, the object under test in a real measurement scenario is usually subjected to three types of radiative effects, making it tested in a completely different way from the measurements with blackbody radiation sources. In this case, part of the incident radiation α may be absorbed, part of ρ may be reflected, and part of τ may be transmitted. Since all these factors depend to varying degrees on wavelength, we use the subscript λ to denote the spectral correlation in its definition. Thus:

- Spectral Absorption Ratio α_λ = the ratio of the spectral radiant power absorbed by an object to the incident radiant power.

- Spectral Reflectance Ratio ρ_λ = the ratio of the spectral radiant power reflected by an object to the incident radiant power.

- Spectral Transmittance Ratio τ_λ = the ratio of the spectral radiant power transmitted from an object to the incident radiant power.

For any wavelength, the sum of these three coefficients must always be equal to 1, so we can derive the following relation:

$$\alpha_\lambda + \rho_\lambda + \tau_\lambda = 1$$

For solid materials the transmittance, τ_λ , is usually considered to be 0, so Eq. can be simplified to:

$$\alpha_\lambda + \rho_\lambda = 1$$

Describing the blackbody emissivity ε produced by an object at a particular temperature requires the use of another coefficient called the radiance ratio.

Therefore, we introduce the following definition:

- Spectral radiance ratio ε_λ = the ratio of the spectral radiant power emitted by an object to the radiant power of a blackbody at the same temperature and wavelength.

According to Kirchhoff's law, the ratio of spectral radiation and the ratio of spectral absorption of an object of any material at any specified temperature and wavelength are equal. That is, $\alpha_\lambda = \varepsilon_\lambda$

From this the above equation can be converted to: $\varepsilon_\lambda + \rho_\lambda = 1$

According to the formula, the larger the value of ε_λ and the smaller the value of ρ_λ , the more accurate the acoustic thermography is.

Therefore, the ability of the thermal imager to accurately measure the temperature of the object under test has a strong relationship with the object's own emissivity ε_λ .

13.1 Emissivity

Emissivity is the ratio of the energy radiated outward from the object being measured to the energy radiated by a blackbody at the same temperature and wavelength, and the emissivity setting is critical to the ability of the thermal imager to accurately measure temperature.

Theoretically, the emissivity of a blackbody radiator is 1; in practice, the emissivity of the object under test is always between 0.1 and 1.0. The larger the value of the emissivity, the higher the emissivity and the stronger the ability to radiate thermal radiation to the outside world.

The emissivity of an object is related to parameters such as the material of the object, surface structure, temperature and wavelength. Generally electrically and thermally insulating materials such as wood and rubber have high emissivity, while metal emissivity is lower than rubber, and even lower for metals with polished surfaces.

! Note: thermal imager temperature measurement need to pay attention to the emissivity $\epsilon > 0.5$ of the object can be measured accurately, when the emissivity $\epsilon < 0.5$ due to the reflection of the radiation has a greater impact is not easy to measure accurately.

13.2 Emissivity Setting

Infrared thermal imager observation, can penetrate the smoke, fog, dust and disturbances, for the visible light background interference is not sensitive, day and night is exactly the same; but the material of the object under test, the surface structure and other parameters affecting the emissivity of the object is very sensitive. For example, the emissivity of human skin ϵ is 0.98, the emissivity of paper ϵ is 0.9, the emissivity of oxidized copper surface ϵ is 0.68, and the emissivity of polished copper surface ϵ is 0.02. Different emissivities of different surfaces bring completely different imaging effects, and the emissivity can be set to improve the accuracy of the temperature measurement effectively, but it cannot change the thermal distribution of the image display.

The methods of thermal imager emissivity settings can be categorized into the following 3 application scenarios:

1. The material of the material is known and the specific emissivity value can be found in the material emissivity table and the emissivity $\epsilon > 0.5$;
2. The material of the material is unknown and the specific emissivity value cannot be found in the material emissivity table;
3. Material surface emissivity $\epsilon < 0.5$

14 About this Manual

This manual is intended to be used as a guide. The photographs, graphics, icons and illustrations provided in this manual are for explanatory and illustrative purposes only and may differ from the specific product, so please refer to the actual product. Due to product version upgrade or other needs, FOTRIC may update this manual without prior notice.

Trademarks and images used in this brochure are for illustrative purposes only and are copyrighted by the trademark owner.

statement denying or limiting responsibility

The products (hardware, software, etc.) provided in this manual may contain defects, errors, or failures, and FOTRIC makes no warranties of any kind, either express or implied, including, but not limited to, warranties of merchantability, satisfaction of quality, fitness for a particular purpose, and non-infringement of third-party rights, etc. FOTRIC shall not be liable for any special, incidental, occasional, or consequential damages resulting from the use of this manual or our products, including, but not

limited to, damages resulting from loss of business profits, loss of data, or loss of documentation. This includes, but is not limited to, damages resulting from loss of business profits, loss of data or documentation.

To the fullest extent permitted by law, our liability will not exceed the amount you paid for the Product.

After the product is connected to the Internet, it may face risks including but not limited to network attacks, hacker attacks, virus infections, etc. For the problems caused by the product working abnormally, information leakage, etc., the Company is not responsible, but will provide you with technical support in a timely manner.

The product can sense motion detection and fire events when properly installed and configured, but cannot prevent accidents or resulting personal injury or property damage.

Thermal imaging products are classified by the U.S. Department of Commerce as an export controlled product under Export Control Classification Number (ECCN) 6A003.b.4.b. This product contains a focal plane array under Export Control Classification Number (ECCN) 61002.a.3.f. This product is not to be used in a controlled country (e.g., North Korea, Iran, Syria, Cuba, Sudan, etc.) Do not bring the product into, or use it in, a controlled country. Any loss or liability arising from the

above behavior will be at your own risk.

When using this product, you are requested to comply strictly with applicable laws. You agree that this product is for civilian use only and shall not be used for infringement of third party rights, medical/safety equipment or other applications in which a product failure could result in life-threatening or personal injury, and fog of mass destruction, biological/chemical weapons, nuclear explosions, or any unsafe use of nuclear energy or uses that are dangerous or contrary to humanitarianism. Any loss or liability arising from such use will be at your own risk.

In the event of a conflict between the above and the applicable law, the provisions of the law shall prevail.