

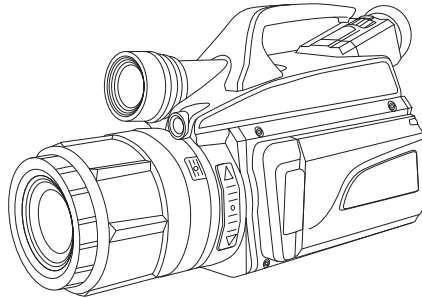

ICI

INFRARED CAMERAS INC

GAS DETECTOR SERIES QUICK START GUIDE



ICI cameras fall under US Federal Law and Export Control.

2105 W. Cardinal Dr. Beaumont, TX 77705
Phone: (409) 861-0788
Toll Free: (866) 861-0788
infraredcameras.com
support@infraredcameras.com
We Are IR™

©Copyright 2022, Infrared Cameras, Inc. - All rights reserved. The contents of this document may not be reproduced in whole or in parts without the written consent of the copyright owner.

Printed in the United States of America.

2105 W. Cardinal Dr.
Beaumont, TX 77705
(866) 861-0788
www.infraredcameras.com

Revision: 02.2022-001

THE MANUFACTURER RESERVES THE RIGHT TO ALTER THE SPECIFICATIONS OF THE PRODUCT WITHOUT PRIOR NOTIFICATION. THE MANUFACTURER ALLOWS HIMSELF THE RIGHT TO MODIFY WITHOUT ANY PRELIMINARY OPINION THE TECHNICAL SPECIFICATIONS OF THE PRODUCT. THIS MANUAL MAY CONTAIN TECHNICAL INACCURACIES OR TYPOGRAPHICAL ERRORS.

NOTICE ALL STATEMENTS, INFORMATION, AND RECOMMENDATIONS IN THIS MANUAL ARE BELIEVED TO BE ACCURATE BUT ARE PRESENTED WITHOUT WARRANTY OF ANY KIND. NOTWITHSTANDING ANY OTHER WARRANTY HEREIN, ALL DOCUMENT FILES AND SOFTWARE ARE PROVIDED "AS IS" WITH ALL FAULTS. ICI DISCLAIMS ALL WARRANTIES, EXPRESSED OR IMPLIED, INCLUDING, WITHOUT LIMITATION, THOSE OF MERCHANTABILITY, FITNESS FOR A PARTICULAR PURPOSE AND NONINFRINGEMENT OR ARISING FROM A COURSE OF DEALING, USAGE, OR TRADE PRACTICE.

THE SOFTWARE LICENSE AND LIMITED WARRANTY FOR THE ACCOMPANYING PRODUCT ARE SET FORTH IN THE INFORMATION PACKET THAT SHIPPED WITH THE PRODUCT AND ARE INCORPORATED HEREIN BY THIS REFERENCE. IF YOU ARE UNABLE TO LOCATE THE SOFTWARE LICENSE OR LIMITED WARRANTY, CONTACT YOUR ICI REPRESENTATIVE FOR A COPY.

IN NO EVENT SHALL ICI BE LIABLE FOR ANY INDIRECT, SPECIAL, CONSEQUENTIAL, OR INCIDENTAL DAMAGES, INCLUDING, WITHOUT LIMITATION, LOST PROFITS OR LOSS OR DAMAGE TO DATA ARISING OUT OF THE USE OR INABILITY TO USE THIS MANUAL, EVEN IF ICI HAS BEEN ADVISED OF THE POSSIBILITY OF SUCH DAMAGES.

Package Includes

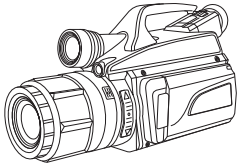

Gas DetectIR Device

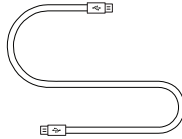

USB Cable

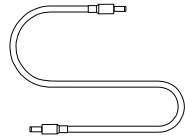

AV Cable

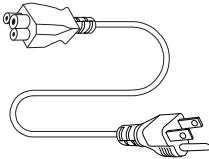

Power Adapter Cable

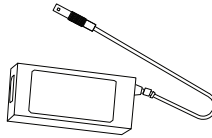

Power Adapter

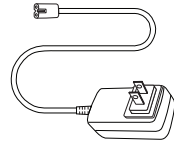

Charger Cable

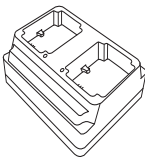

Charging Base

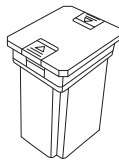

Battery



SD Card

ENSURE ALL SYSTEM EQUIPMENT AND COMPONENT ITEMS ARE PRESENT BEFORE BEGINNING INSTALLATION

Set Up

A.

The camera can be used as a handheld device.

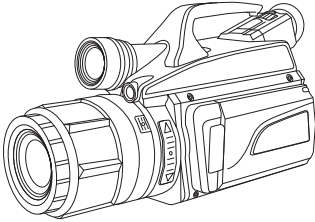

OR

Mount the fully charged device to a tripod using the $\frac{1}{4}$ "-20 mount located on the body.

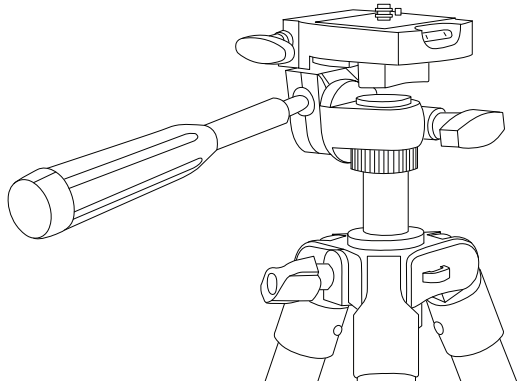
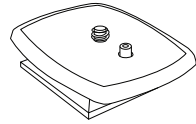
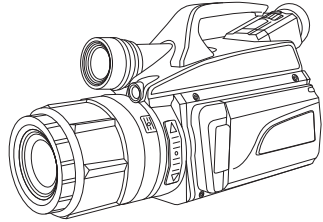

MAKE SURE TRIPODS DO NOT BLOCK THE DIRECT PATH OF THROUGH TRAFFIC TO ENSURE THE EQUIPMENT WILL NOT BE MOVED OR KNOCKED DOWN. USING A DIVIDING BARRIER WILL HELP KEEP TRIPODS SEPARATE FROM THE PATH.

TURN ON THE CAMERA BY PRESSING AND HOLDING THE POWER BUTTON FOR AT LEAST THREE SECONDS.

THE INTERNAL SOFTWARE MAY TAKE UP TO 5 MINUTES TO LAUNCH. DO NOT POWER OFF THE DEVICE OR PRESS BUTTONS WHILE SOFTWARE IS LAUNCHING. PRESSING BUTTONS OR TURNING OFF THE DEVICE MAY CORRUPT THE FILE SYSTEMS.

B.

Power on device.

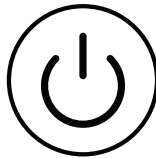

PRESS AND HOLD THE POWER BUTTON FOR MORE THAN 5 SECONDS TO SHUT DOWN THE CAMERA.

THE THERMAL IMAGER NEEDS SUFFICIENT WARM-UP TIME FOR THE MOST ACCURATE TEMPERATURE MEASUREMENTS AND BEST IMAGE QUALITY. THIS TIME CAN OFTEN VARY BY ENVIRONMENTAL CONDITIONS. IT IS BEST TO WAIT A MINIMUM OF 10 MINUTES AFTER THE SOFTWARE HAS FULLY LAUNCHED BEFORE MEASURING TEMPERATURES.

Battery Installation

SET THE THERMAL DEVICE UPRIGHT ON A LARGE FLAT SURFACE WHEN REMOVING OR REPLACING THE BATTERY.

A.

Ensure metal contacts are aligned; then, push the battery into the battery bay until the battery is fully seated in the battery bay. User should hear a click sound.

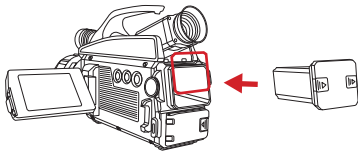

B.

Pinch the battery bay buckles simultaneously. Battery will be released from the battery bay.

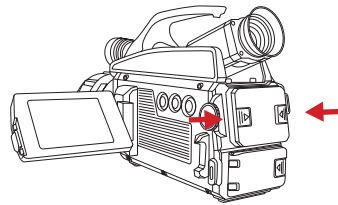

C.

Pull battery from battery bay.

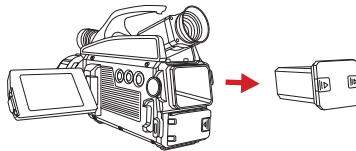

DO NOT FORCE THE BATTERY INTO THE BATTERY BAY. IF USER FEELS SIGNIFICANT RESISTANCE REMOVE THE BATTERY AND ENSURE METAL CONTACTS ARE ALIGNED BEFORE TRYING TO PLACE BATTERY INTO THE BATTERY BAY.

ENSURE BATTERY IS INSERTED PROPERLY. IMPROPER INSERTION OF BATTERY MAY EXPOSE THE BATTERY AND INTERNAL ELECTRONICS TO ELEMENTAL DAMAGE.

Charging Instructions: Option 1

A.

While a battery is inside the device, align the power adapter prongs; then, plug the power adapter cable into the device.

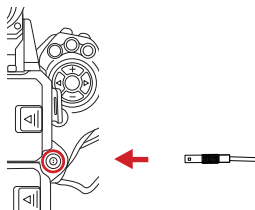

B.

Plug the power adapter cord into the power adapter.

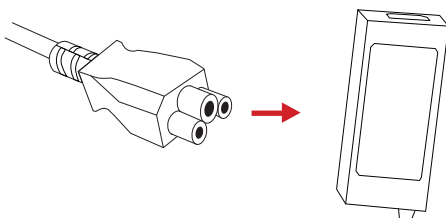

D.

Plug power cord into a 110/120V electrical outlet.

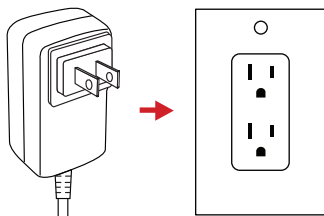

CHARGE THE BATTERY FOR A MINIMUM OF 3 HOURS BEFORE USING THE DEVICE.

ICI DOES NOT RECOMMEND CHARGING THE DEVICE WHILE IT IS ON A TRIPOD. LAY DEVICE FACE DOWN ON A FLAT AND STABLE DESK OR TABLE WHILE CHARGING.

ENSURE THE IMAGER IS NEAR ROOM TEMPERATURE BEFORE CHARGING THE DEVICE. DO NOT CHARGE IN EXTREMELY HOT OR COLD AREAS. THE BATTERY CAPACITY MAY BE DECREASED IF CHARGED IN AN EXTREME TEMPERATURE ENVIRONMENT.

Charging Instructions: Option 2

REMOVE THE BATTERIES FROM THE DEVICE BEFORE CONTINUING WITH THIS METHOD OF CHARGING.

A.

Ensure metal contacts are aligned; then, insert batteries into the battery charging base.

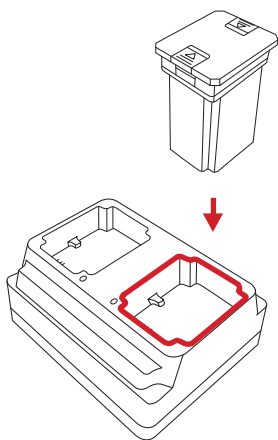

B.

Plug charger cable into the battery charging base.

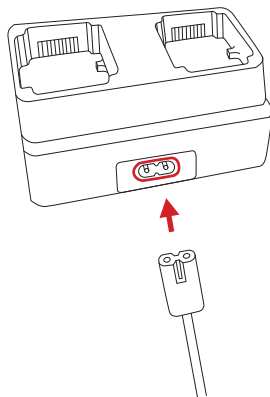

B.

Plug power cord into a 110/120V electrical outlet.

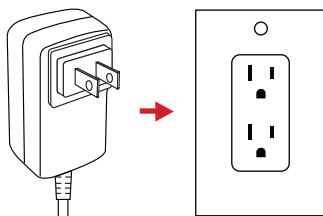

IF YOU DO NOT USE THE IMAGER FOR A LONG PERIOD OF TIME, PUT THE DEVICE IN A COOL AND DRY ENVIRONMENT. THE BATTERY WILL DISCHARGE OVER TIME; THEREFORE, THE IMAGER SHOULD BE CHARGED OCCASIONALLY TO PREVENT DAMAGE TO THE BATTERY OR THE DEVICE.

Memory Card

SET THE THERMAL DEVICE UPRIGHT ON A LARGE FLAT SURFACE WHEN REMOVING OR REPLACING THE BATTERY.

A.

Slide the connector bay latch lock and open the connector bay latch door.

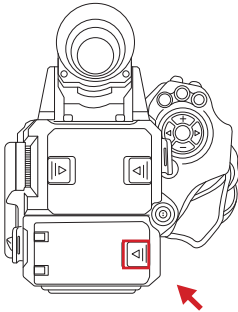

B.

Slide the battery bay cover latch.

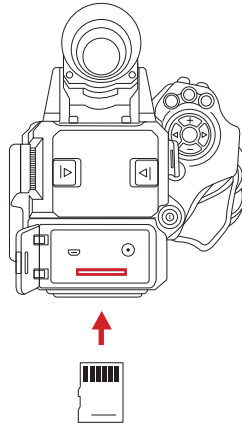

C.

Close the battery bay lock. User should hear a click sound.

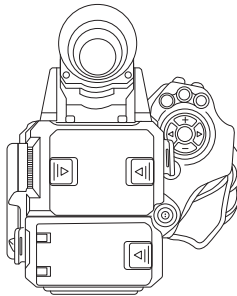

DO NOT FORCE SD CARD INTO THE SLOT. THE SIDE OF THE CARD WITH CONTACT PINS MUST BE INSERTED FIRST. IF THERE IS RESISTANCE FLIP THE CARD AROUND AND TRY AGAIN.

About ICI / Contact

Infrared Cameras, Inc.
2105 W. Cardinal Dr.
Beaumont, TX 77705

Phone: (409) 861-0788 | Toll Free: (866) 861-0788 | International: (409) 861-0788

General Inquiry: support@infraredcameras.com

Website: www.infraredcameras.com

You may reach a representative by phone or email Mon – Fri 8:00AM – 5:00PM CST.

ICI manufactures complete systems and software. We can provide complete engineering, software, and OEM solutions. Our Fortune 500 clients rely on us for infrared equipment and thermography training (which we offer through the Infrared Training Institute).

In addition to providing custom germanium, silica, and sapphire optics, we also build windows for enclosures, as well as custom pan and tilt units. We can even provide customizable explosion-proof systems.

Our knowledge and experience stems from years of using infrared imaging and temperature measurement instruments to provide solutions to: managers, engineers, scientists, inspectors and operators in space, power companies, medical, pulp and paper, food industry, research and development, and various process industries. You can see our products and services used in industrial, commercial, and government applications worldwide. Originally named Texas Infrared (still DBA), Infrared Cameras, Inc. has been in business since March, 1995.

Thank you for your dedicated and continued support.